



US00D363684S

**United States Patent** [19]  
**Sikorski et al.**

[11] **Patent Number: Des. 363,684**  
[45] **Date of Patent: \*\*Oct. 31, 1995**

[54] **JEWELRY STONE**

[75] Inventors: **Stanley Sikorski**, Brawford, Conn.;  
**Robert Hurwitz**, Ridgewood, N.J.

[73] Assignee: **Sandberg & Sikorski Diamond Corp.**,  
New York, N.Y.

[\*\*] Term: **14 Years**

[21] Appl. No.: **23,287**

[22] Filed: **May 23, 1994**

[52] U.S. Cl. .... **D11/90**

[58] **Field of Search** ..... D11/1, 2, 3, 4,  
D11/5, 6, 12, 34, 26-32, 89, 90, 222; 63/1.1,  
2, 3, 32

[56] **References Cited**

**U.S. PATENT DOCUMENTS**

D. 81,375 6/1930 Dinhofer ..... D11/90

(List continued on next page.)

*Primary Examiner*—Ralf Seifert  
*Attorney, Agent, or Firm*—Gottlieb, Rackman & Reisman

[57] **CLAIM**

The ornamental design for a jewelry stone, as shown and described.

**DESCRIPTION**

FIG. 1 is a perspective view of a jewelry stone showing my new design;  
FIG. 2 is a top plan view;  
FIG. 3 is a front elevational view;  
FIG. 4 is a right side elevational view;  
FIG. 5 is a left side elevational view;  
FIG. 6 is a rear elevational view;  
FIG. 7 is a bottom plan view;  
FIG. 8 is a perspective view of a jewelry gemstone showing second embodiment of my new design;  
FIG. 9 is a top plan view of the second embodiment thereof;  
FIG. 10 is a front elevational view of the second embodiment thereof;  
FIG. 11 is a right side elevational view of the second

embodiment thereof;  
FIG. 12 is a left side elevational view of the second embodiment thereof;  
FIG. 13 is a rear elevational view of the second embodiment thereof;  
FIG. 14 is a bottom plan view of the second embodiment thereof;  
FIG. 15 is a perspective view of a jewelry gemstone showing a third embodiment of my new design;  
FIG. 16 is a top plan view of the third embodiment thereof;  
FIG. 17 is a front elevational view of the third embodiment thereof;  
FIG. 18 is a right side elevational view of the third embodiment thereof;  
FIG. 19 is a left side elevational view of the third embodiment thereof;  
FIG. 20 is a rear elevational view of the third embodiment thereof;  
FIG. 21 is a bottom plan view of the third embodiment thereof;  
FIG. 22 is a perspective view of a jewelry gemstone showing a fourth embodiment of my new design;  
FIG. 23 is a top plan view of the fourth embodiment thereof;  
FIG. 24 is a front elevational view of the fourth embodiment thereof;  
FIG. 25 is a right side elevational view of the fourth embodiment thereof;  
FIG. 26 is a left side elevational view of the fourth embodiment thereof;  
FIG. 27 is a rear elevational view of the fourth embodiment thereof;  
FIG. 28 is a bottom plan view of the fourth embodiment thereof;  
FIG. 29 is a perspective view of a jewelry gemstone showing a fifth embodiment of my new design;  
FIG. 30 is a top plan view of the fifth embodiment thereof;  
FIG. 31 is a front elevational view of the fifth embodiment thereof;  
FIG. 32 is a right side elevational view of the fifth embodiment thereof;  
FIG. 33 is a left side elevational view of the fifth embodiment thereof;  
FIG. 34 is a rear elevational view of the fifth embodiment thereof; and,  
FIG. 35 is a bottom plan view of the fifth embodiment thereof.

**1 Claim, 5 Drawing Sheets**

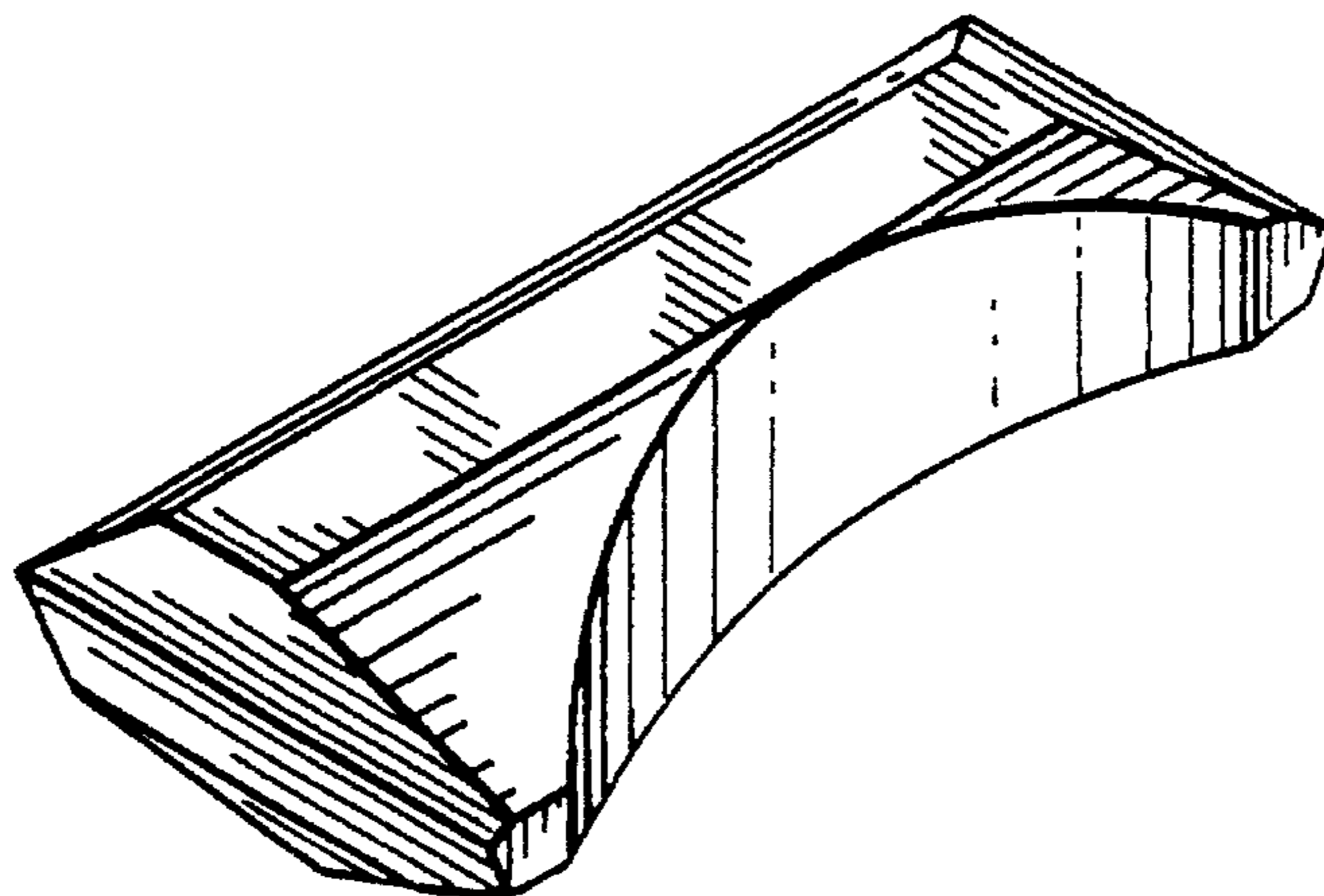

# Des. 363,684

Page 2

---

## U.S. PATENT DOCUMENTS

D. 81,377	6/1930	Dinhofer	.....	D11/90	D. 81,380	6/1930	Dinhofer	.....	D11/90
D. 81,378	6/1930	Dinhofer	.....	D11/90	D. 81,381	6/1930	Dinhofer	.....	D11/90
D. 81,379	6/1930	Dinhofer	.....	D11/90	D. 81,382	6/1930	Dinhofer	.....	D11/90

*FIG. 1*

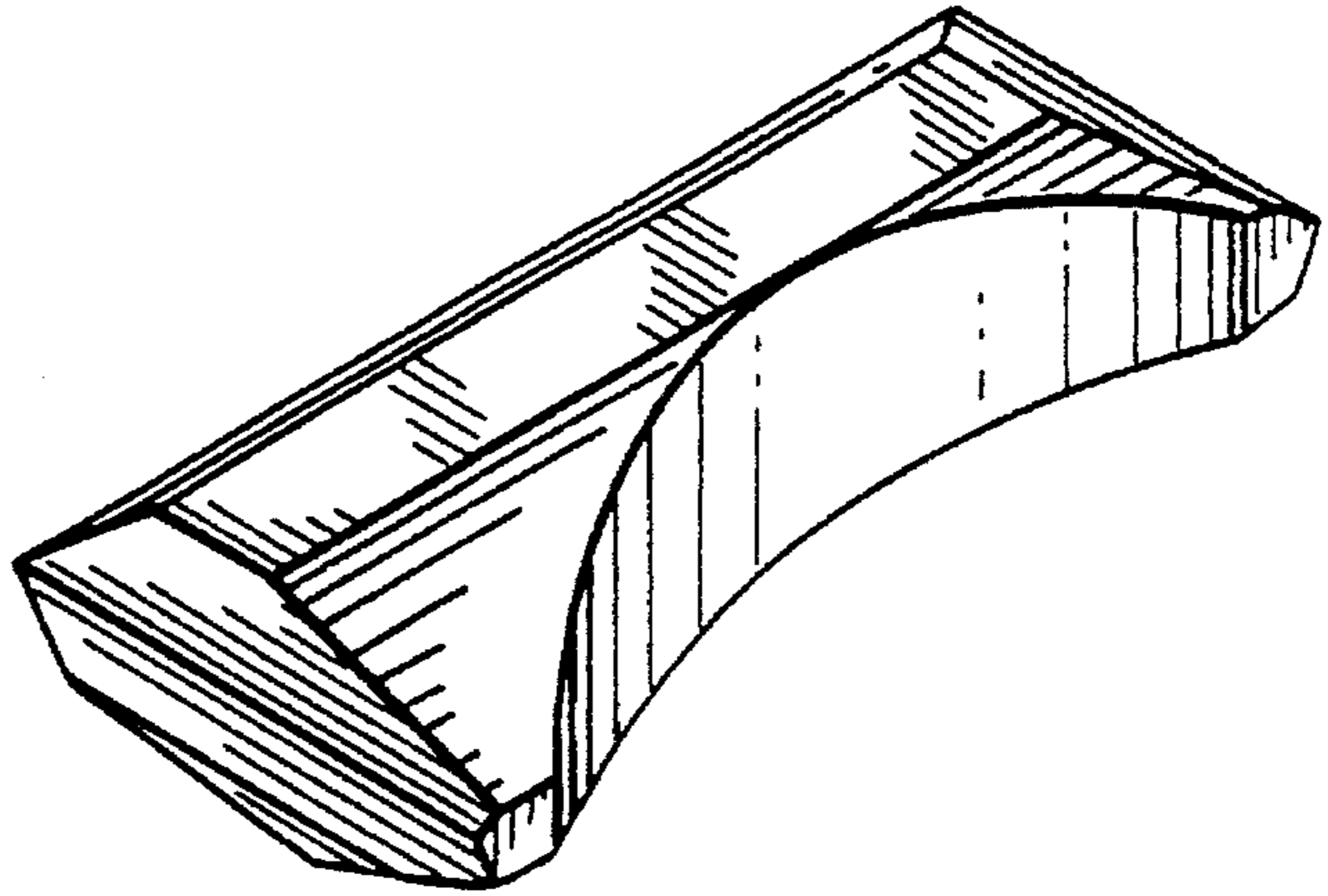

*FIG. 2*

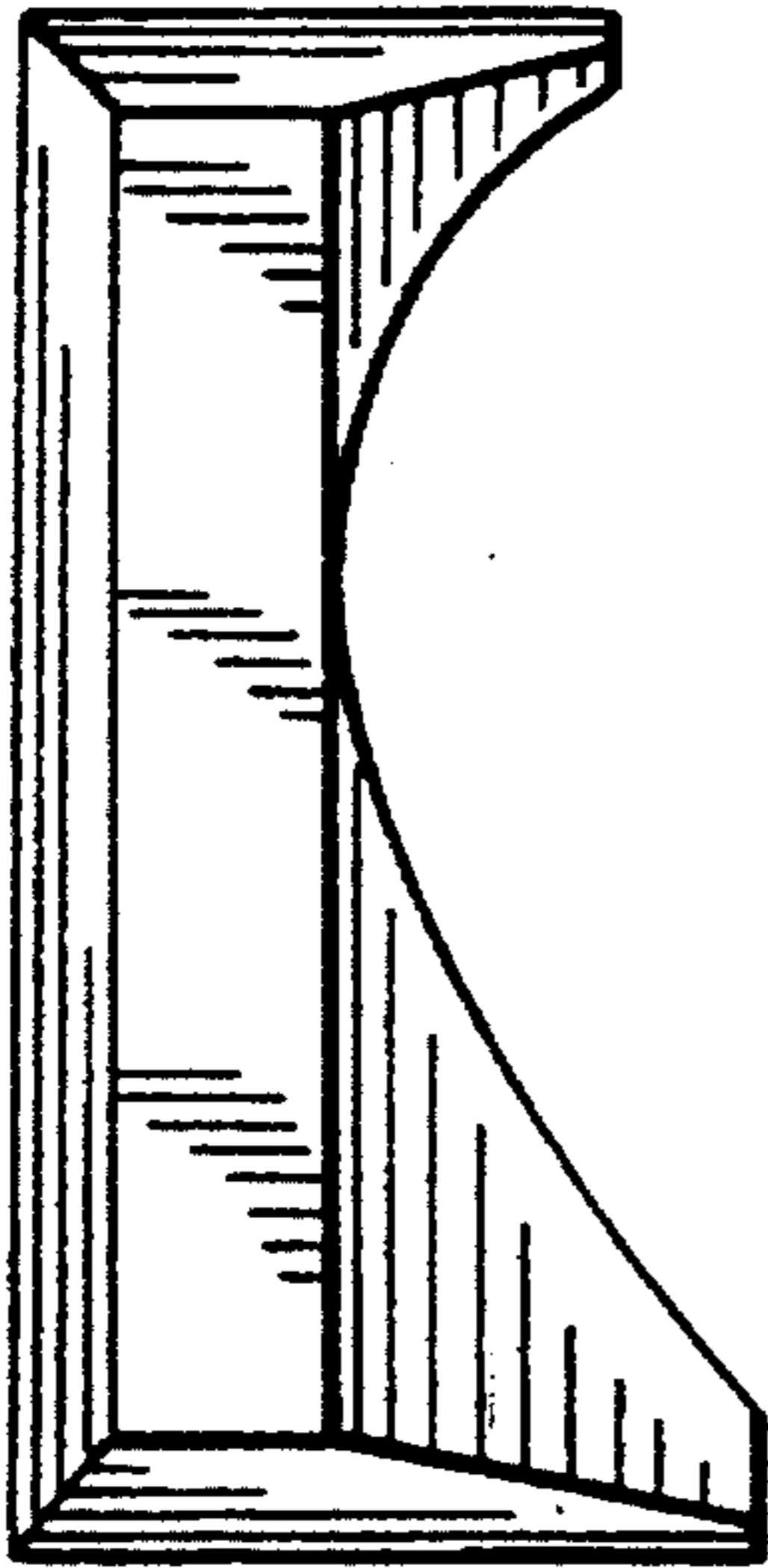

*FIG. 4*

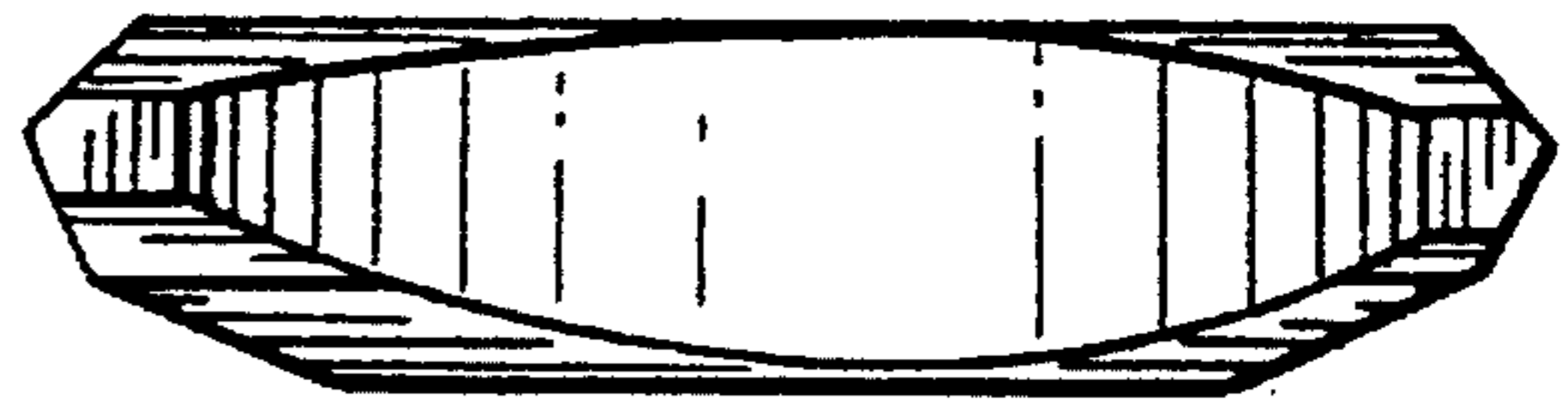

*FIG. 3*

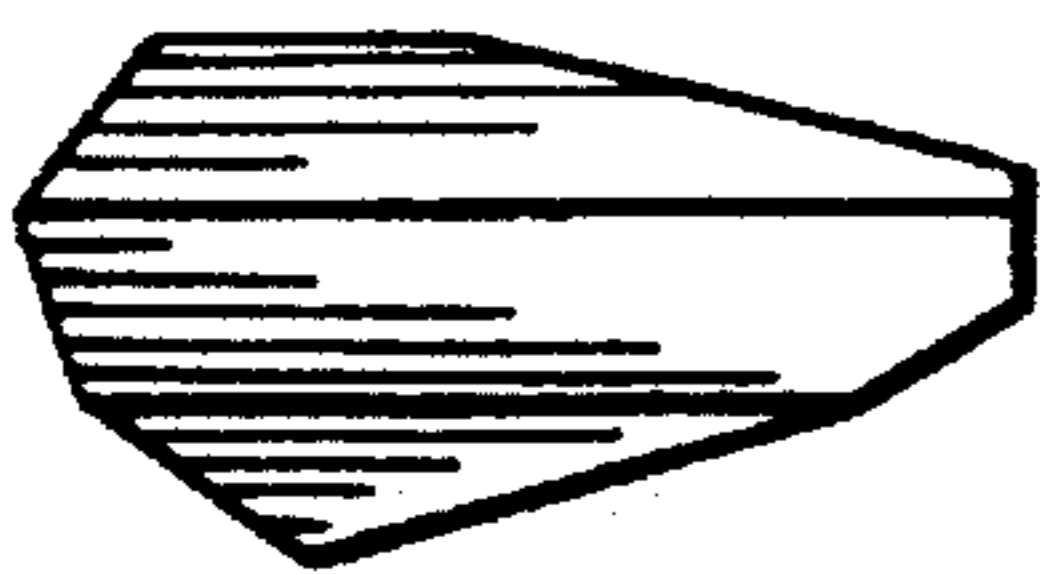

*FIG. 5*

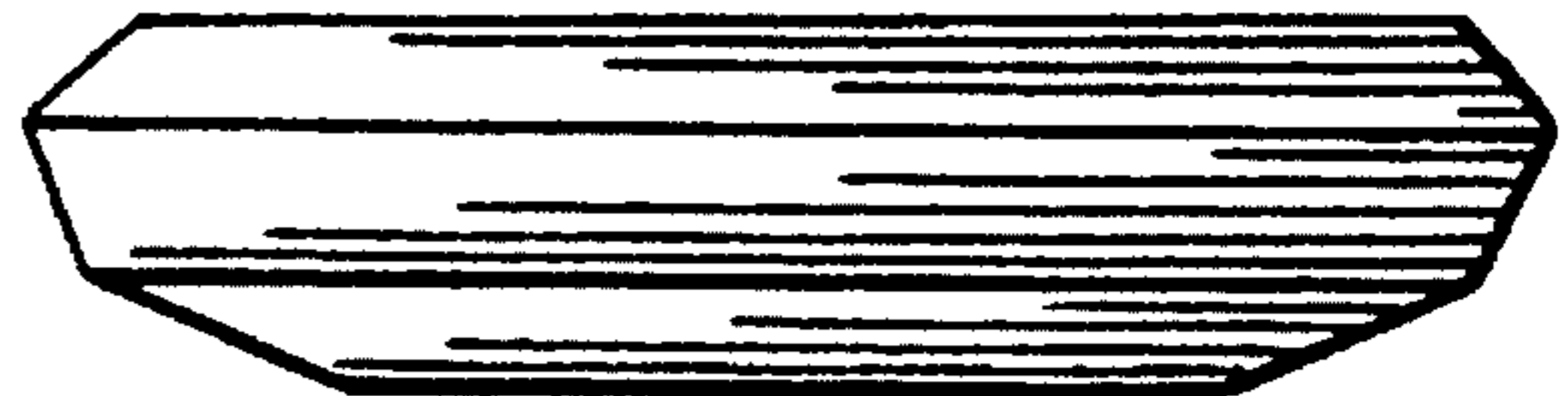

*FIG. 6*

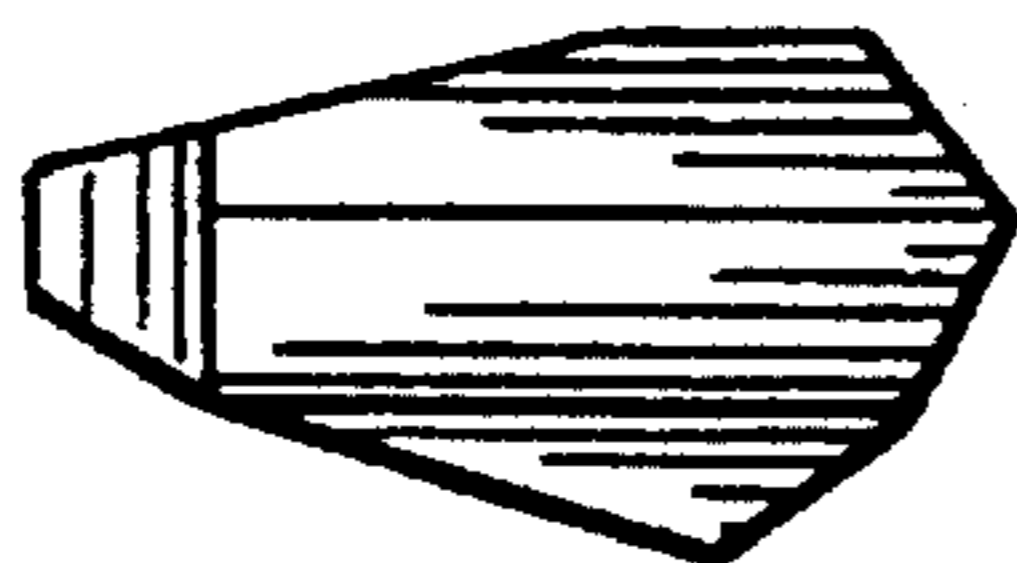

*FIG. 7*

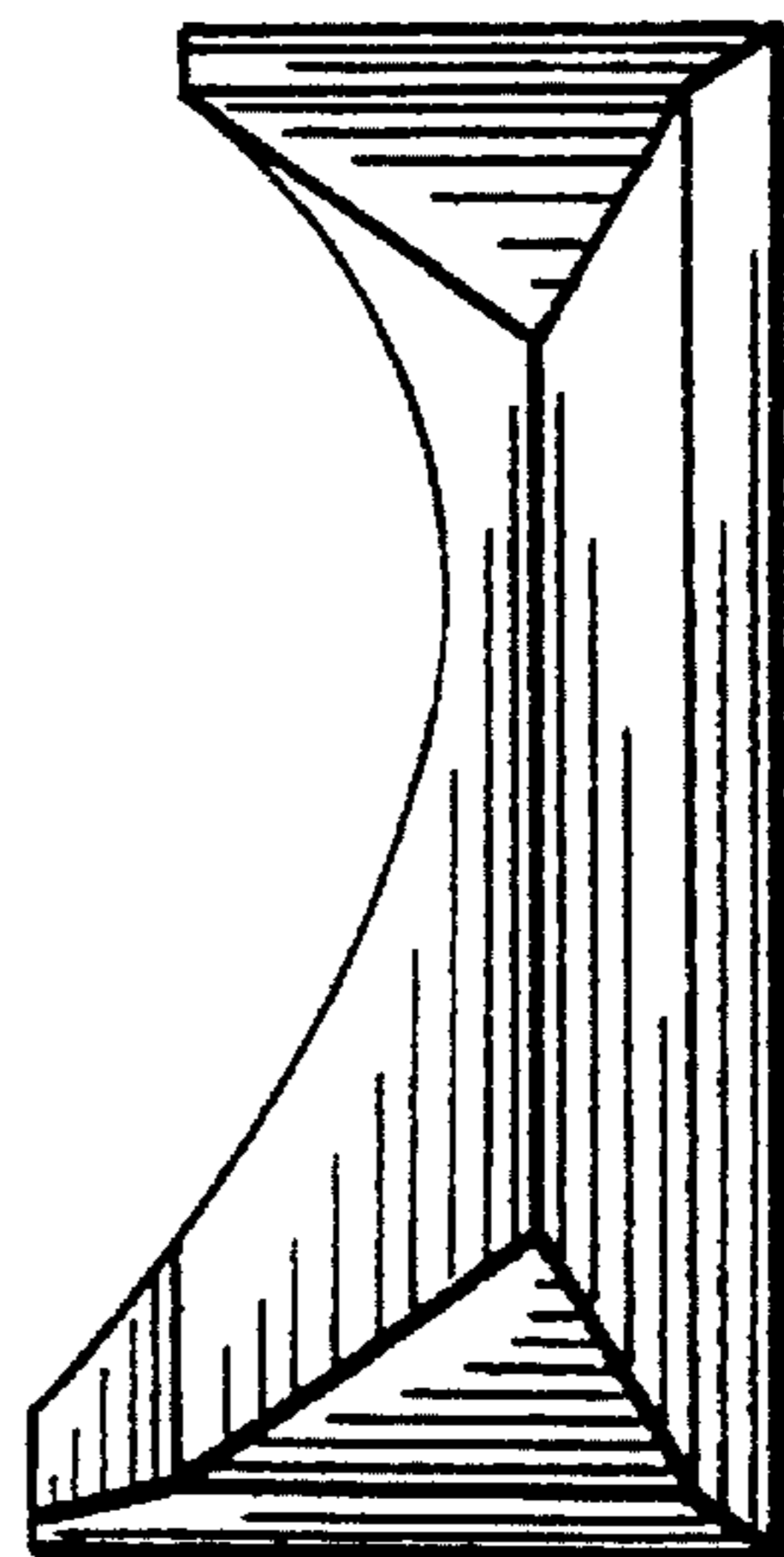

*FIG.8*

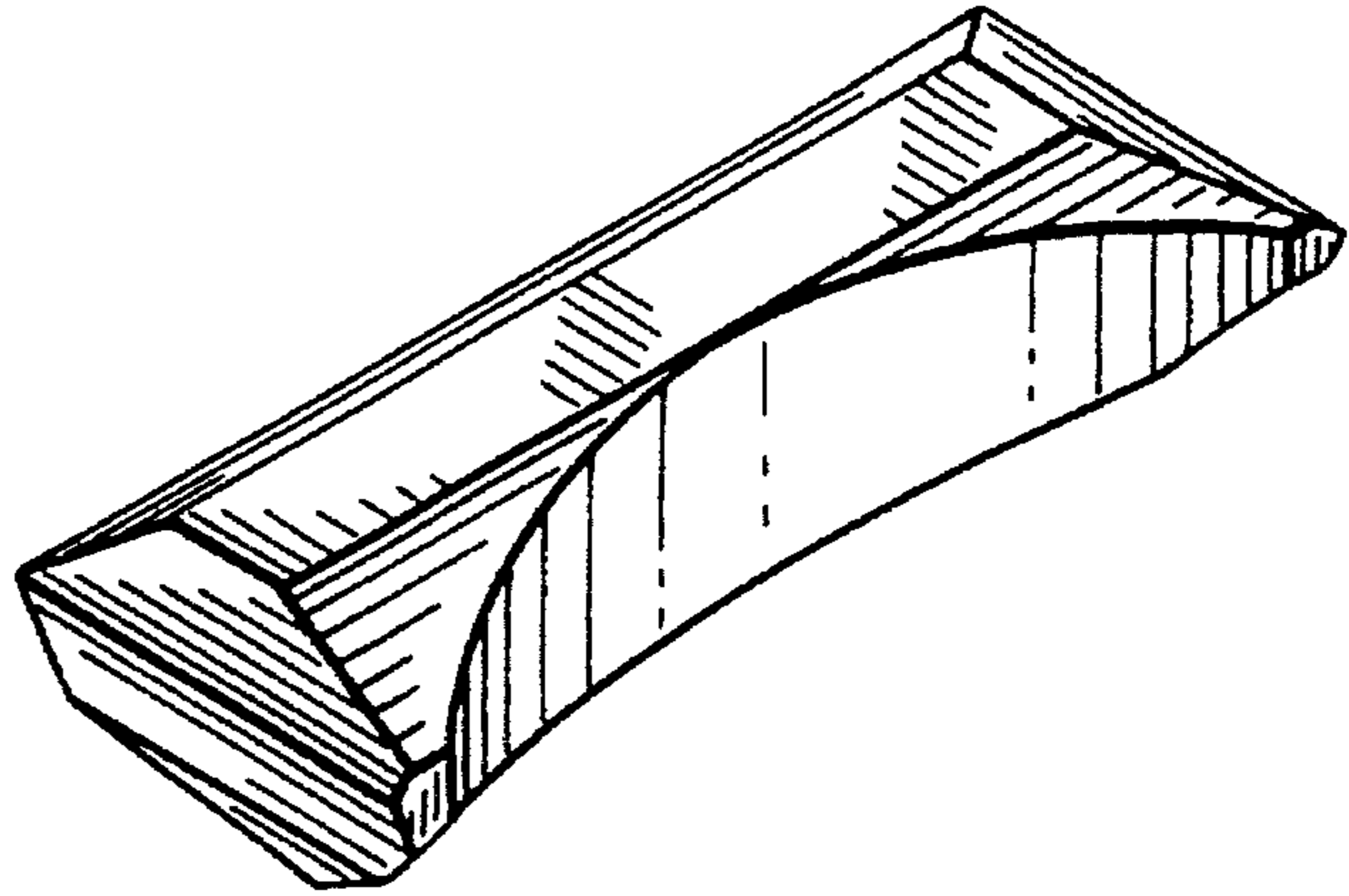

*FIG.9*

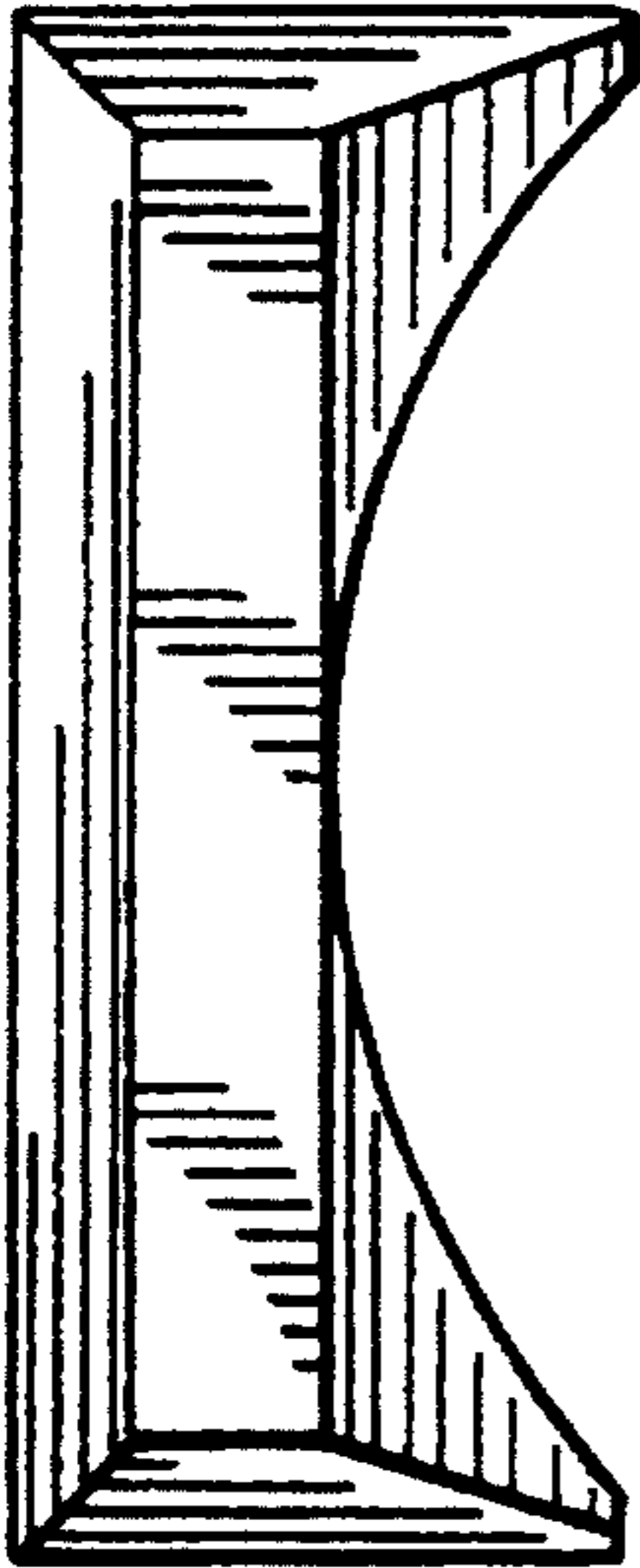

*FIG.11*

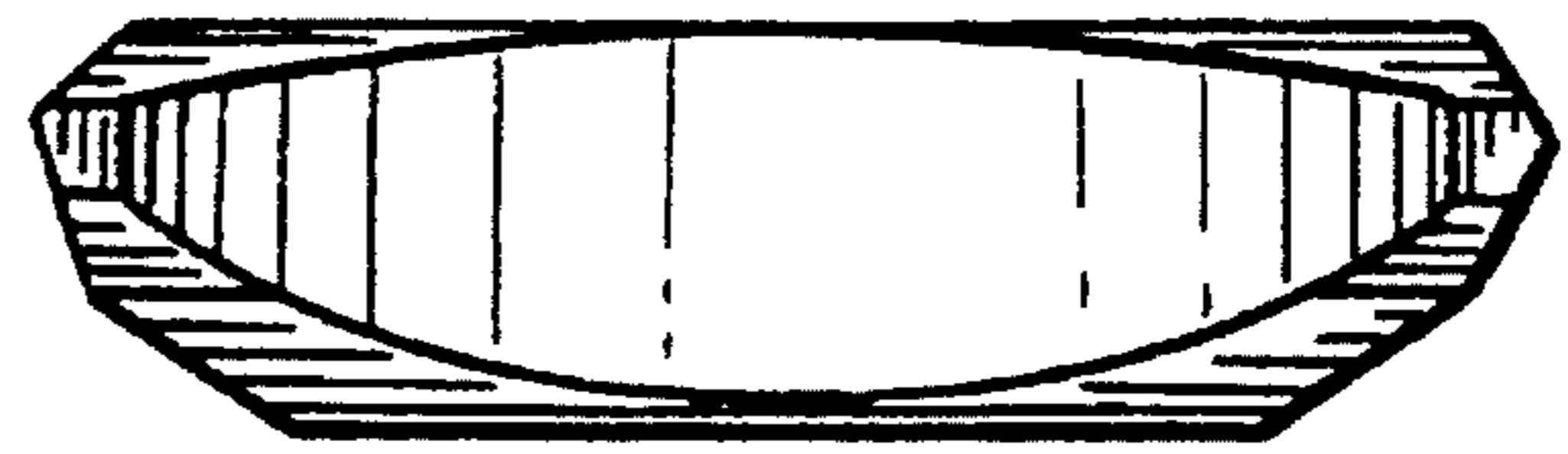

*FIG.12*

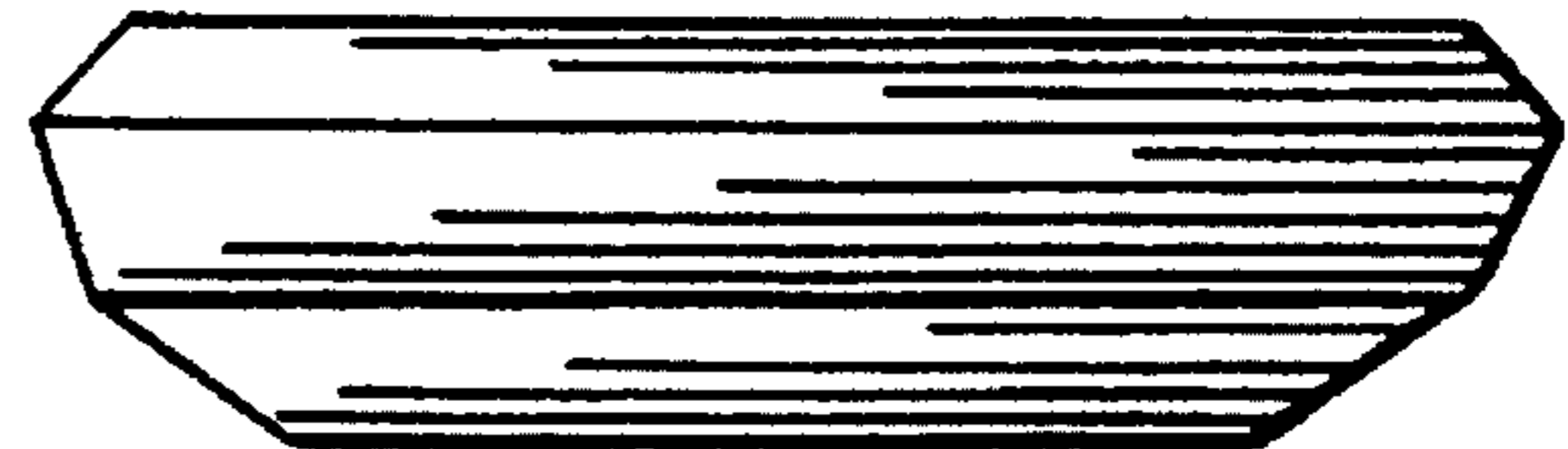

*FIG.10*

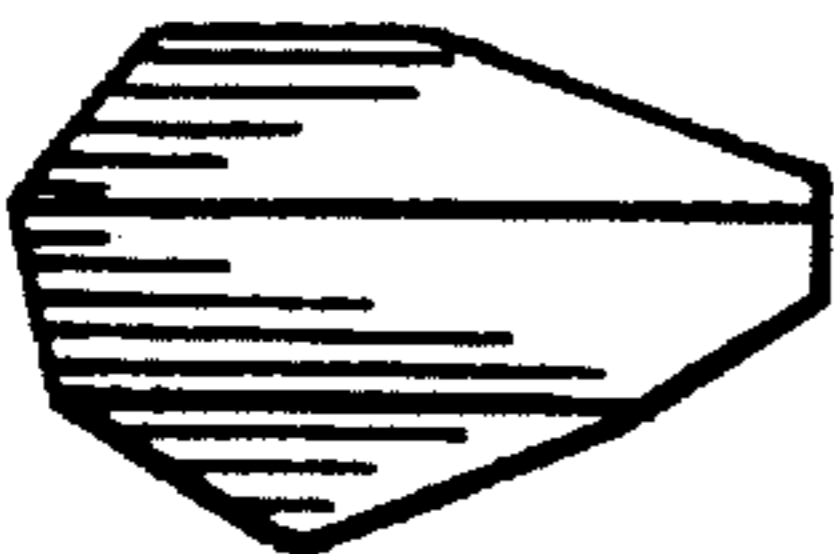

*FIG.13*

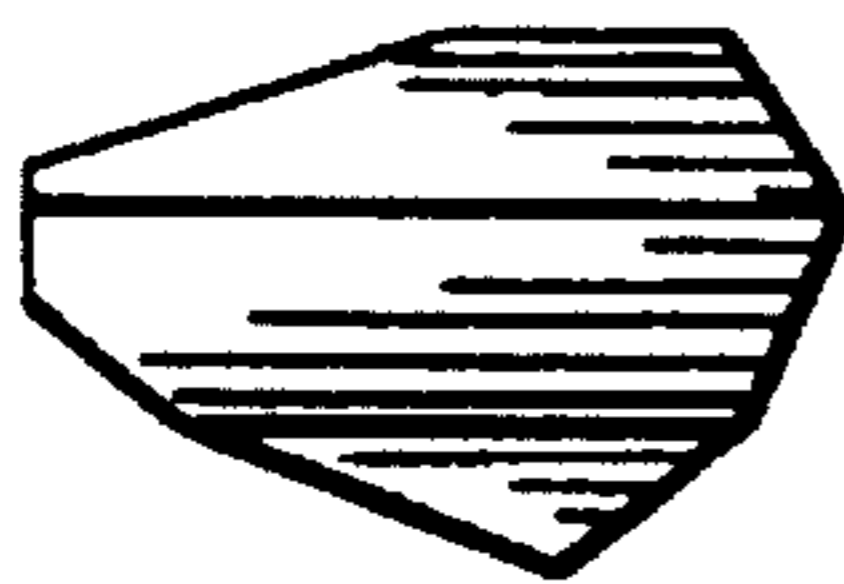

*FIG.14*



*FIG.15*

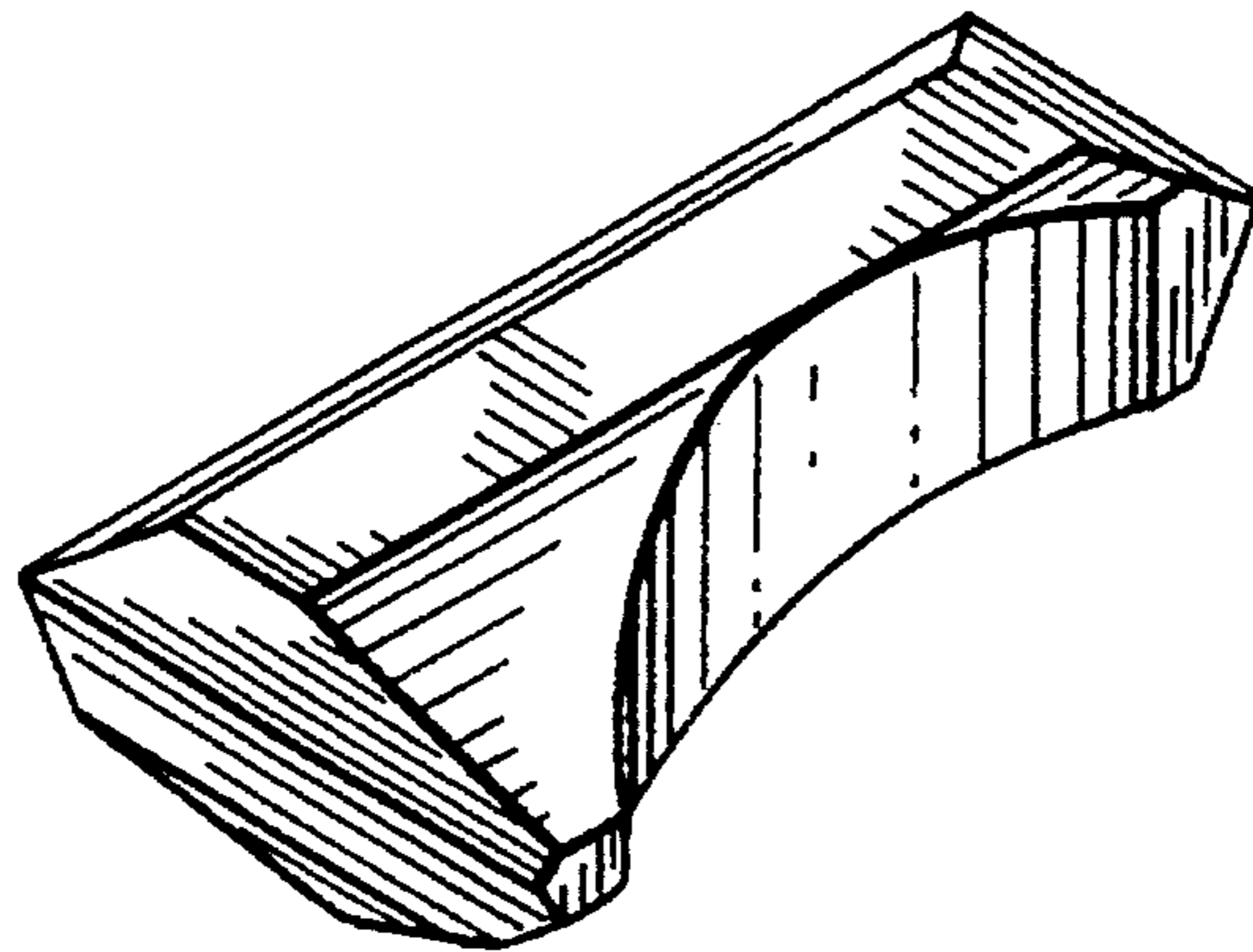

*FIG.16*

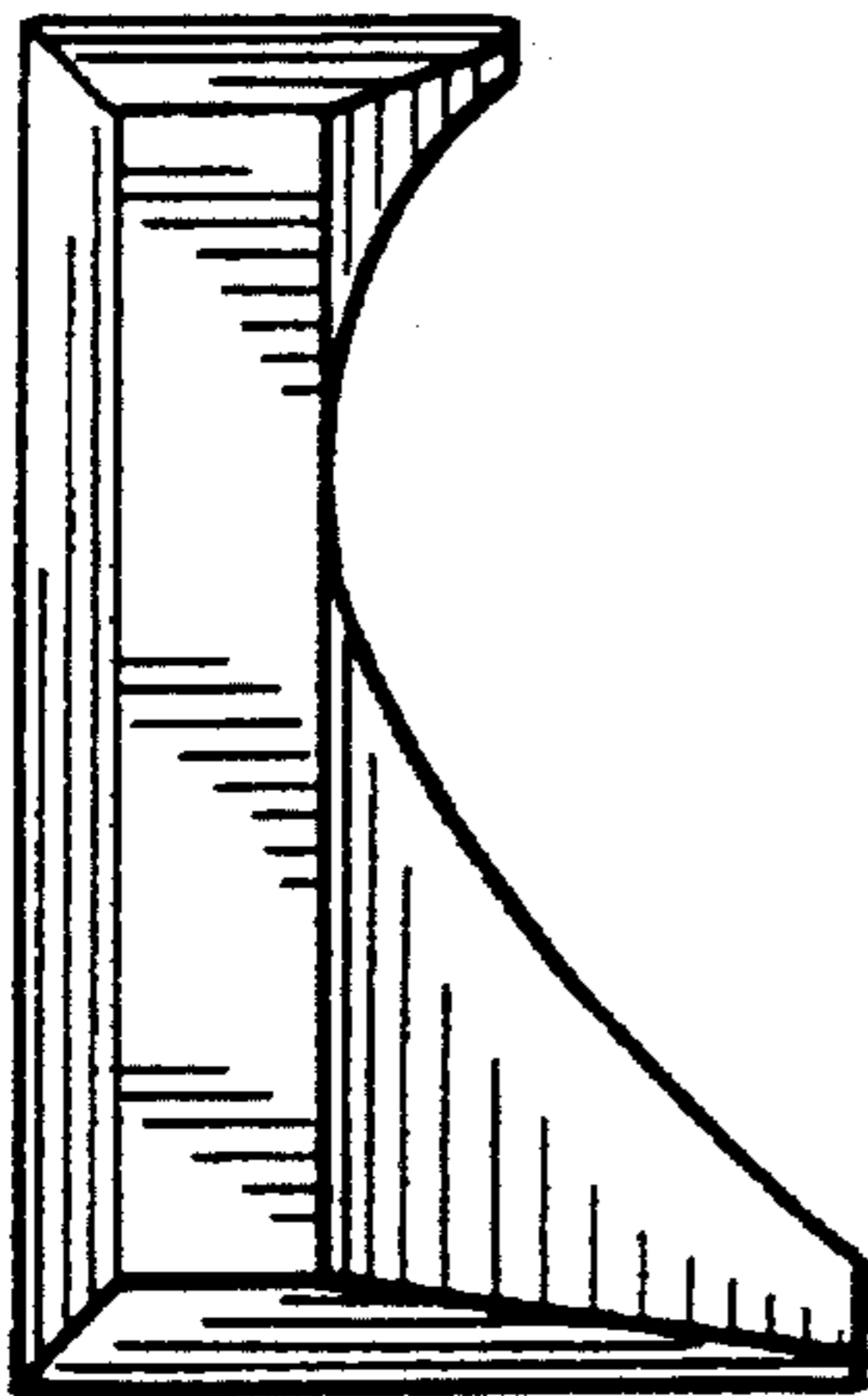

*FIG.18*

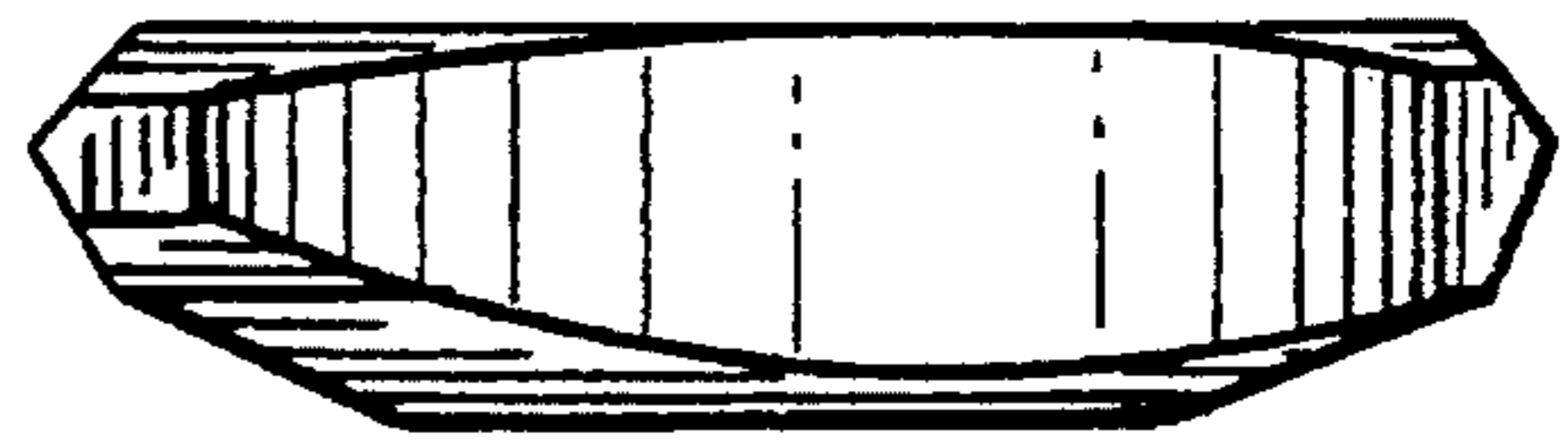

*FIG.19*

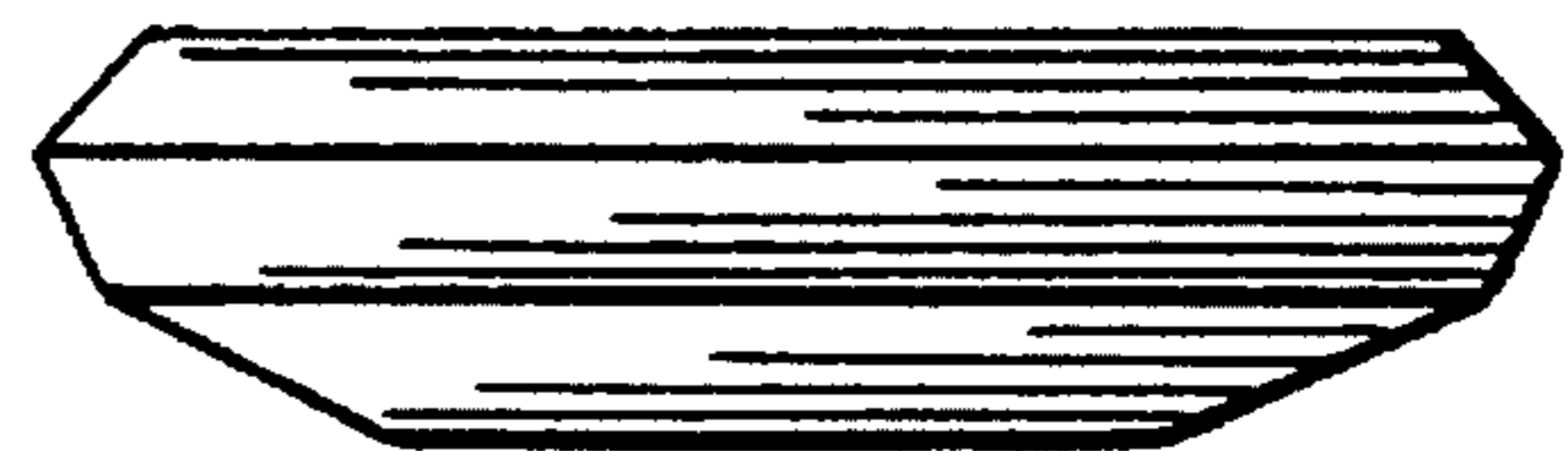

*FIG.17*

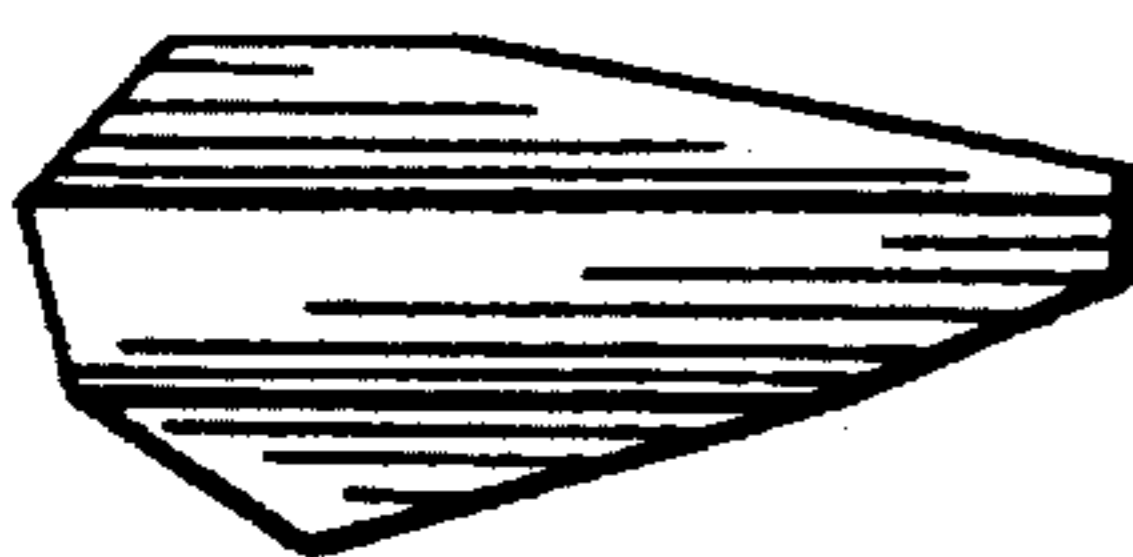

*FIG.20*

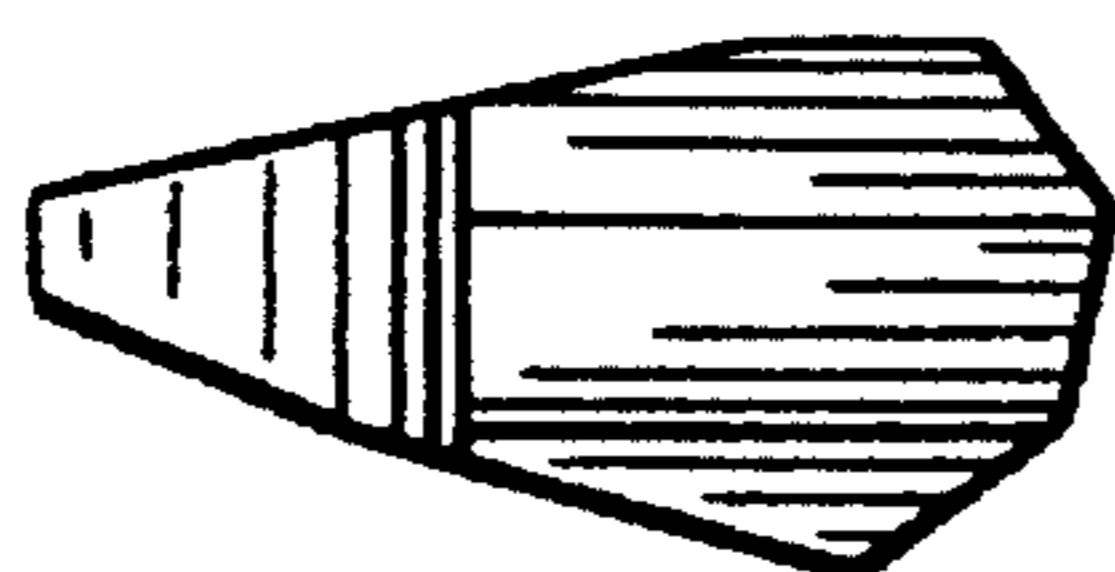

*FIG.21*

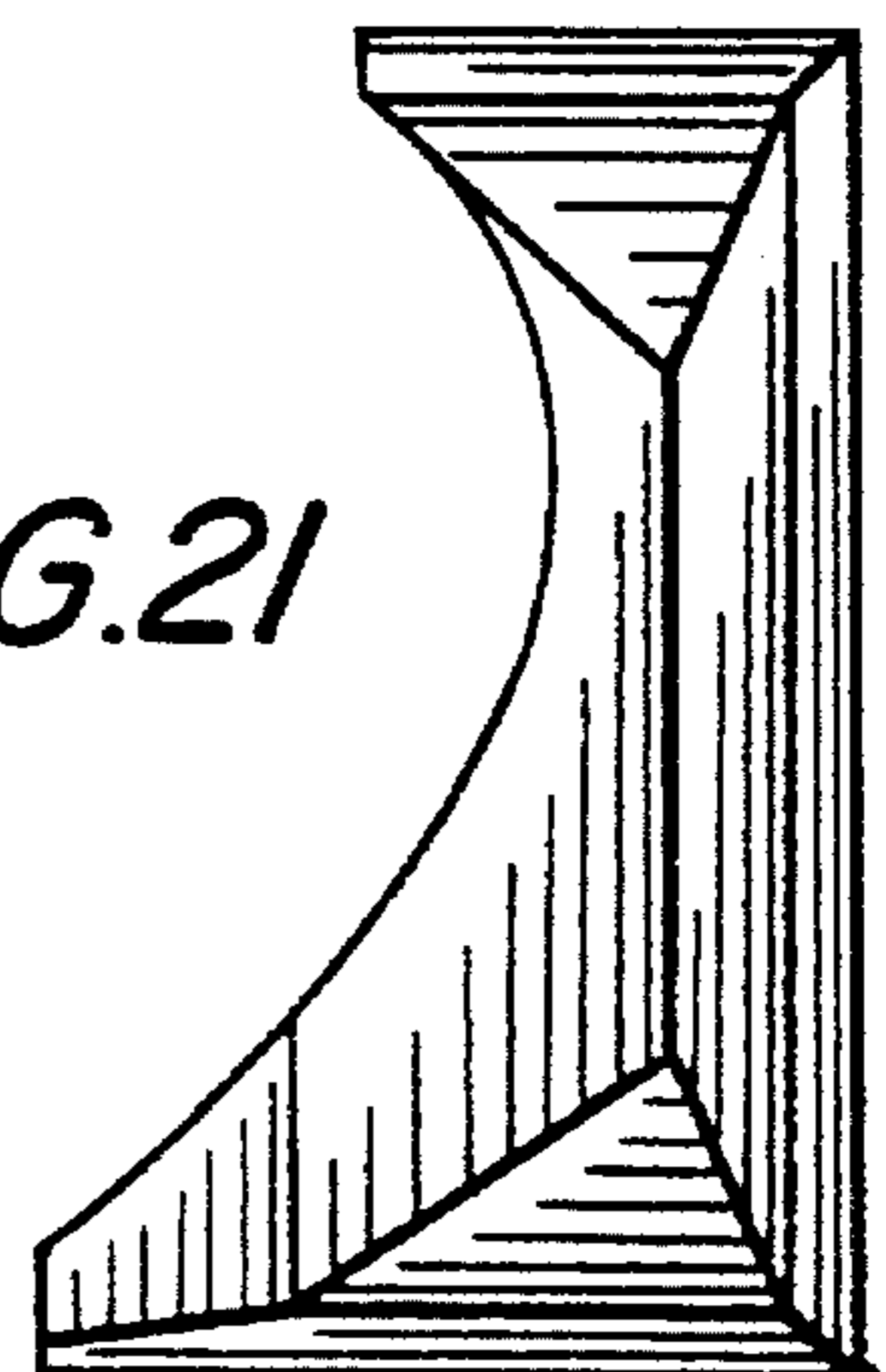

*FIG.22*

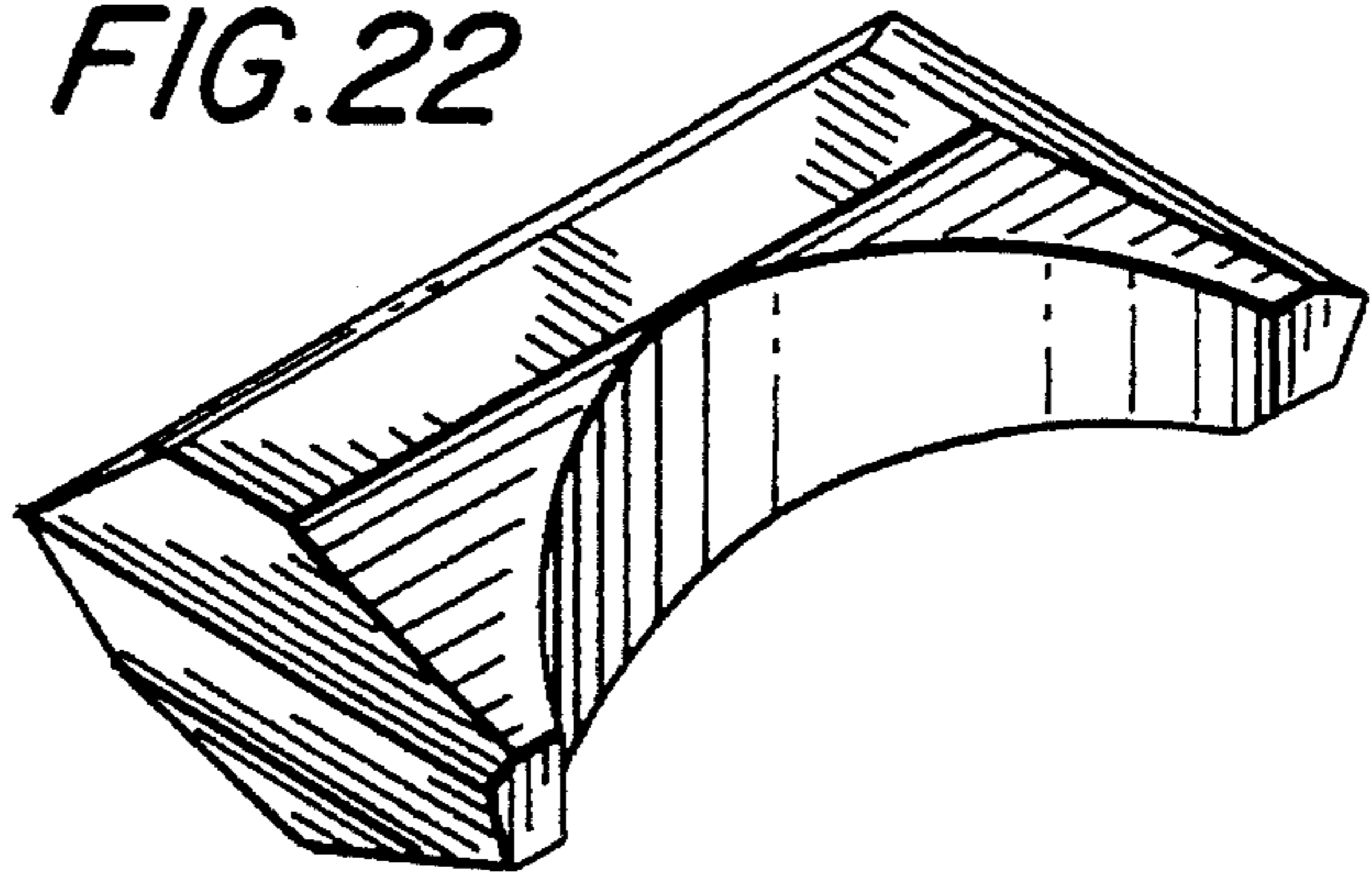

*FIG.23*

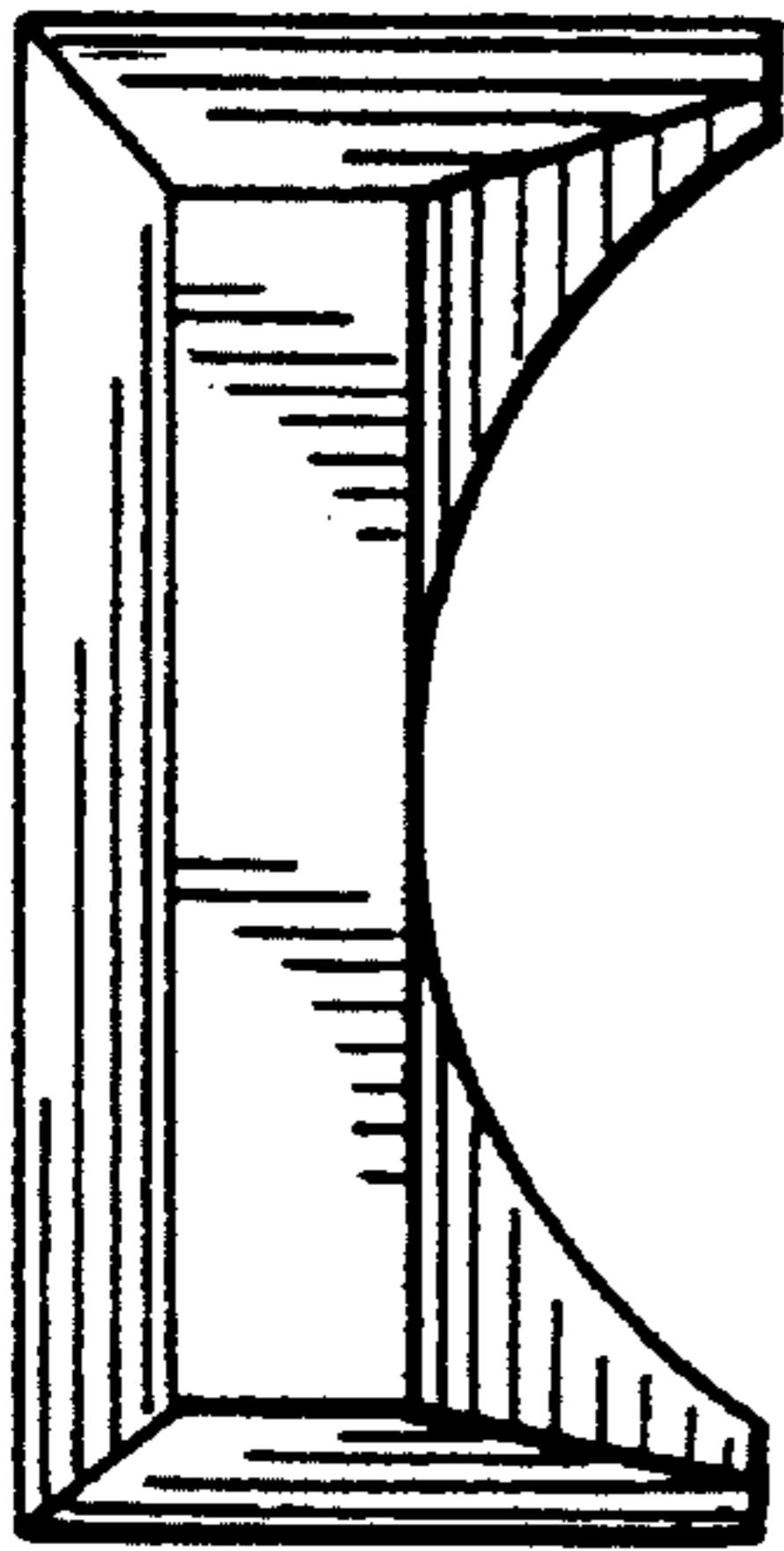

*FIG.25*

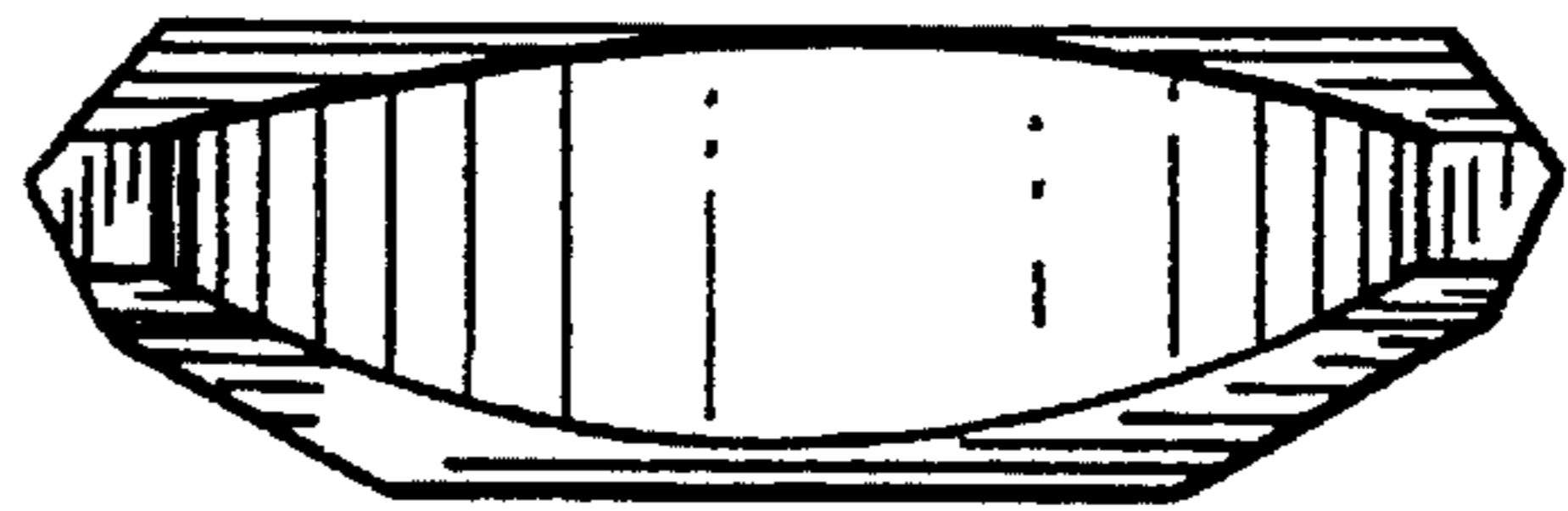

*FIG.26*

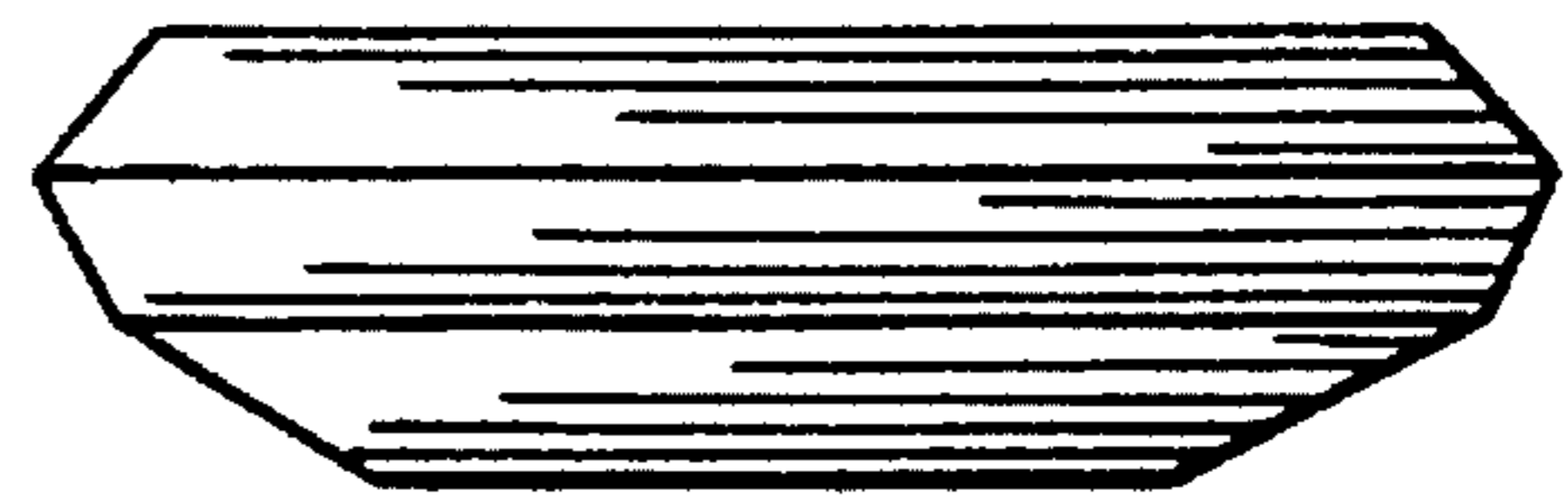

*FIG.24*

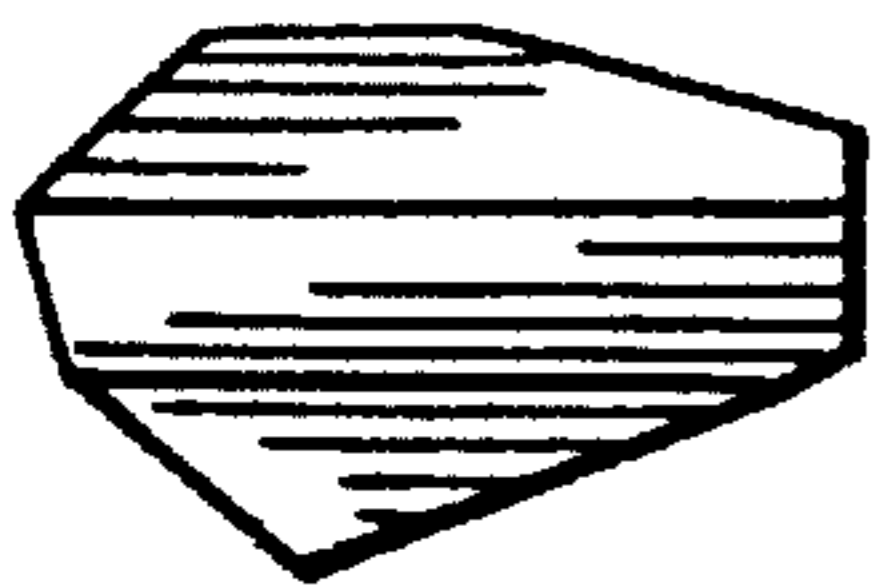

*FIG.27*

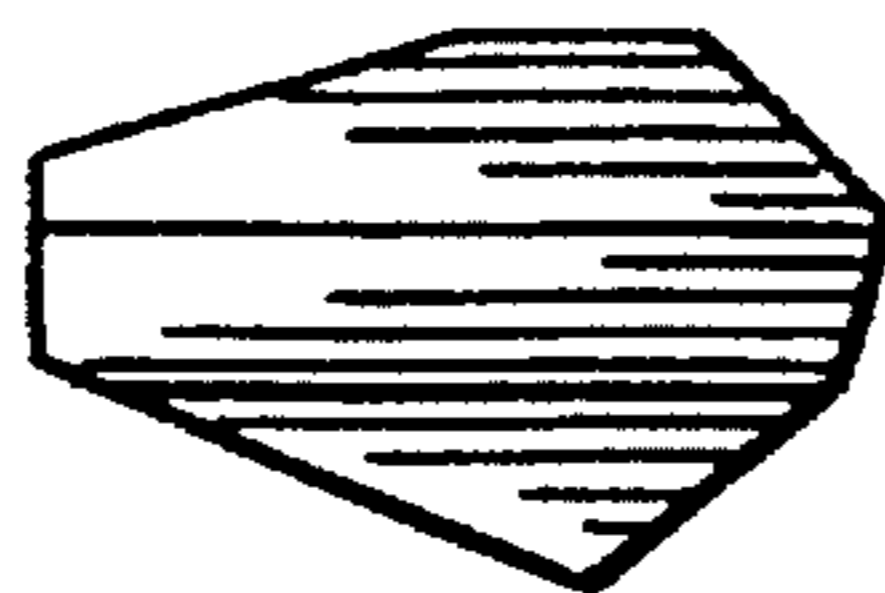

*FIG.28*

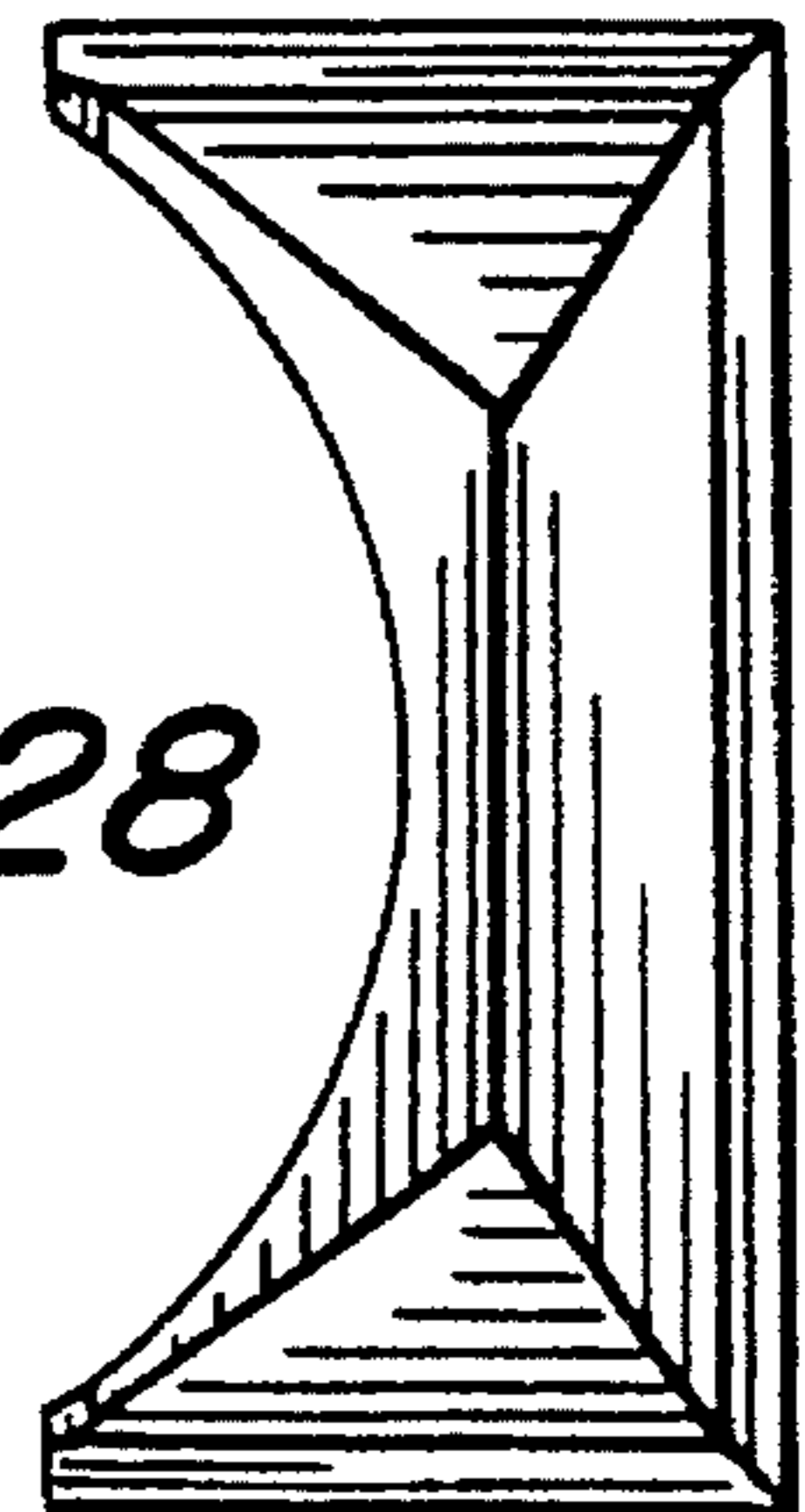

*FIG.29*

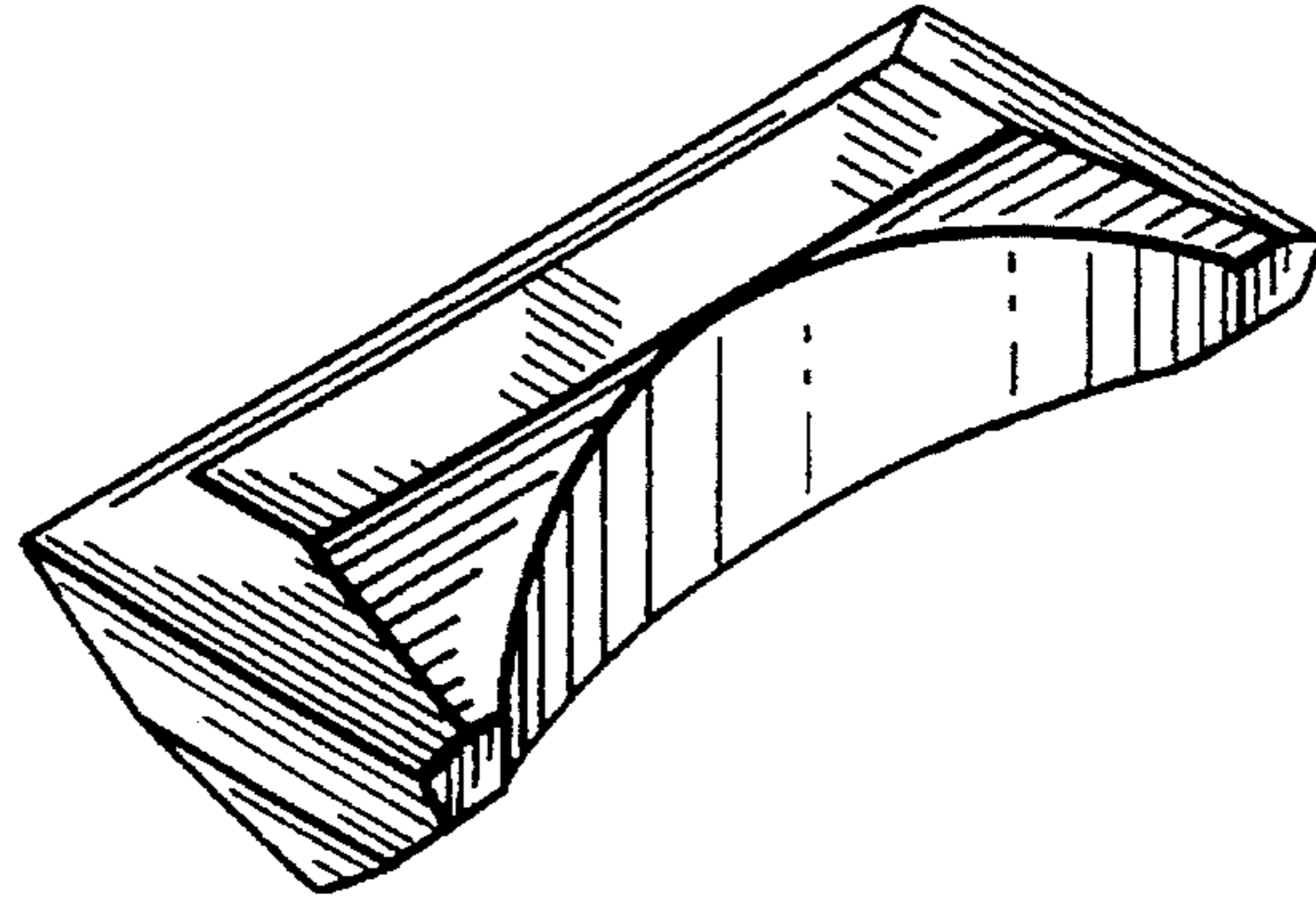

*FIG.30*

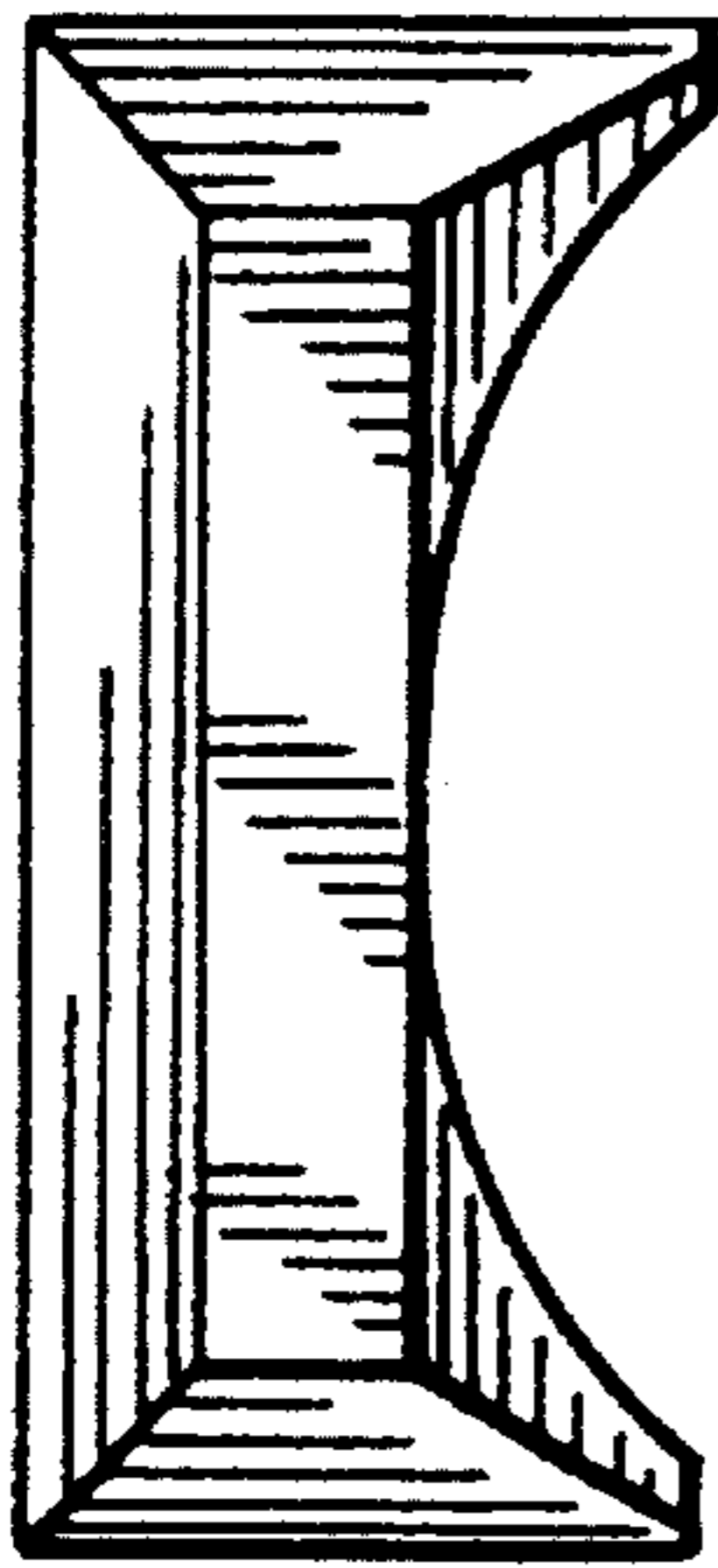

*FIG.32*

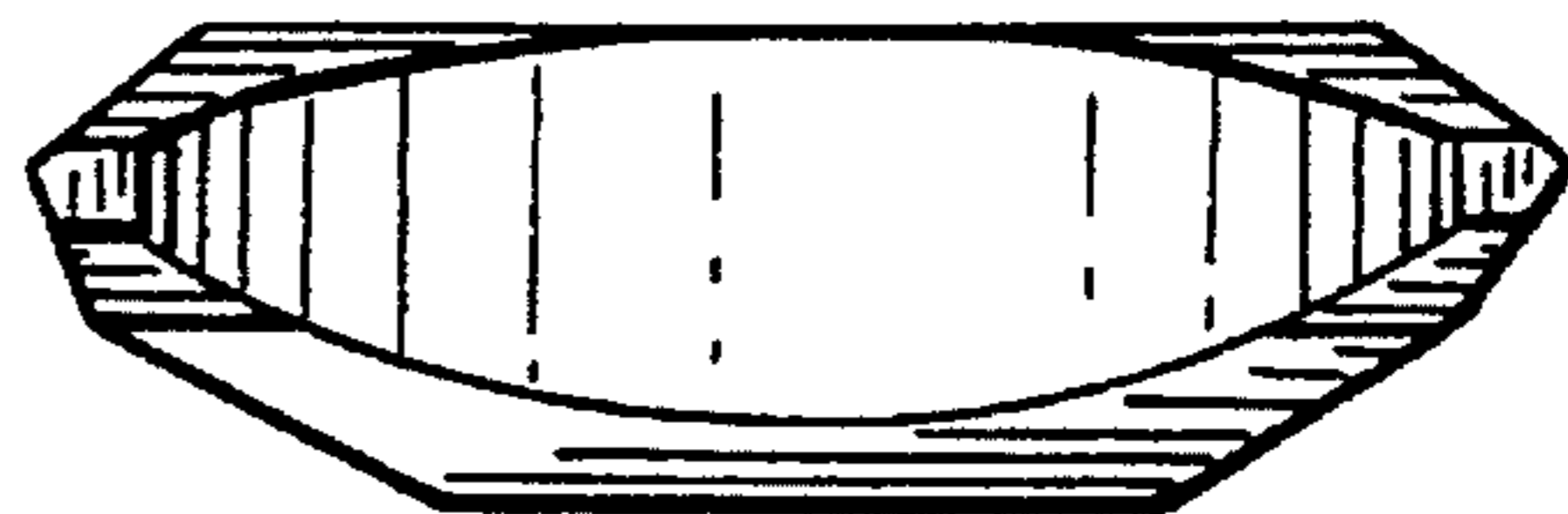

*FIG.31*

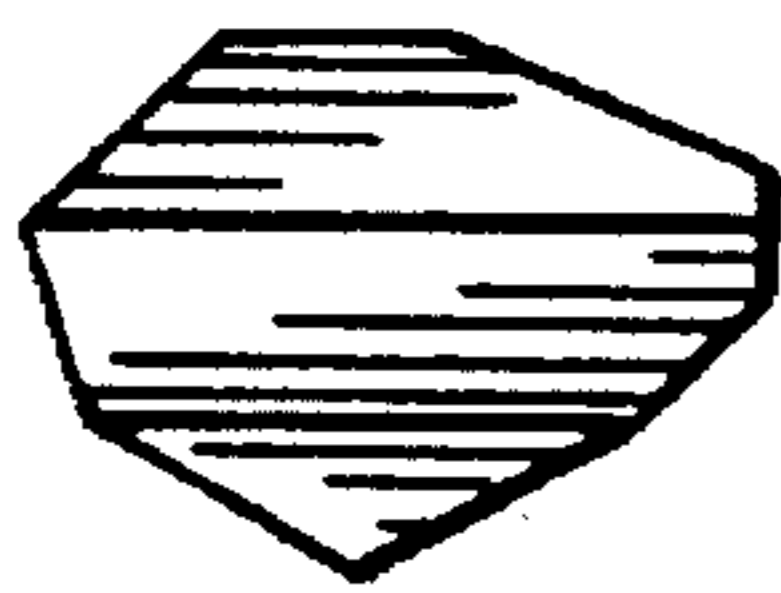

*FIG.33*

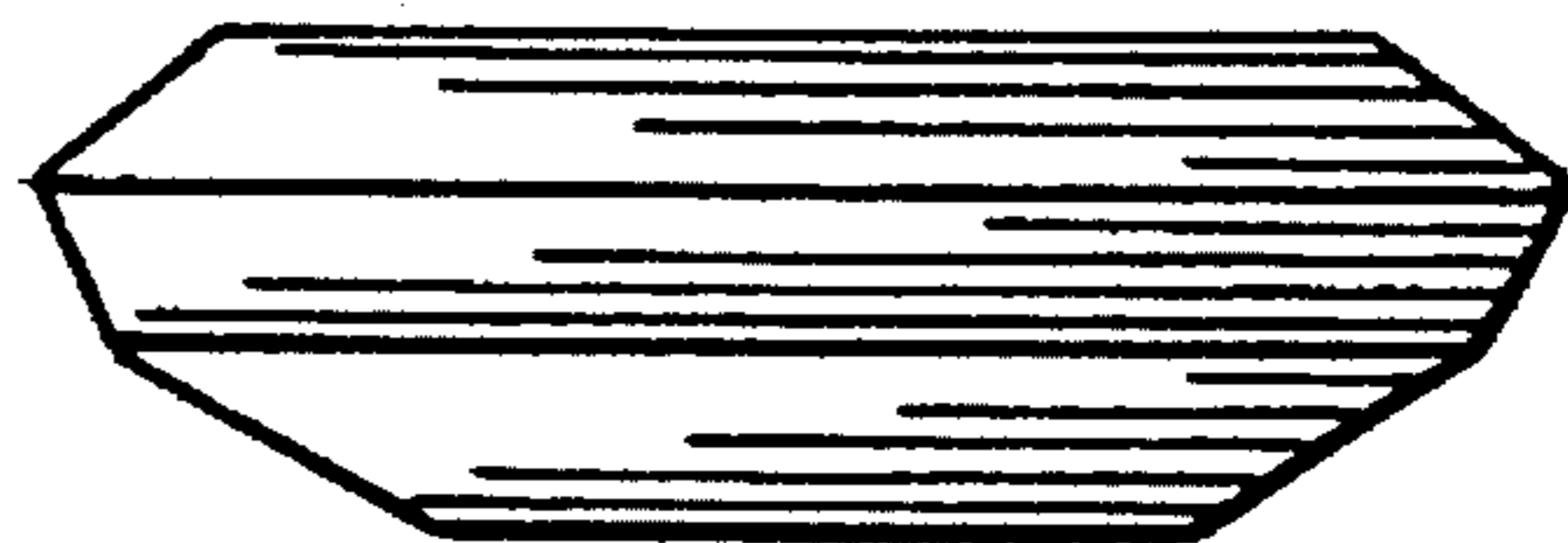

*FIG.34*

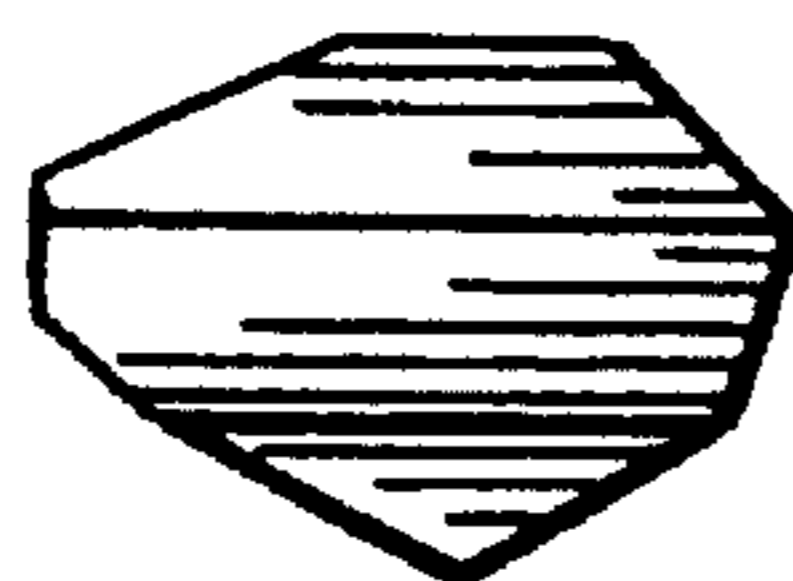

*FIG.35*

