



US00D363649S

United States Patent [19]

[11] Patent Number: **Des. 363,649**

Robbins, III

[45] Date of Patent: ****Oct. 31, 1995**

[54] **DISPENSING CONTAINER**

[76] Inventor: **Edward Robbins, III**, 2802 E. Avalon Ave., Muscle Shoals, Ala. 35661

[**] Term: **14 Years**

[21] Appl. No.: **26,369**

[22] Filed: **Jul. 26, 1994**

[52] U.S. Cl. **D7/612; D7/589; D9/523**

[58] Field of Search **D7/589, 612-615, D7/321, 510; D9/523; 222/142.4, 142.5, 424.5, 425, 454, 456, 480, 481; 215/1 R, 1 C**

[56] **References Cited**

U.S. PATENT DOCUMENTS

D. 323,781	2/1992	Hamly et al.	D9/523 X
D. 350,877	9/1994	Van Valkenburg et al.	D7/612
2,370,820	3/1945	Stott .	
2,840,124	6/1958	Greene .	
3,168,223	2/1965	Capers .	
4,144,989	3/1979	Joy .	

4,408,703	10/1983	Libit .
4,646,948	3/1987	Jennings .
4,955,513	9/1990	Bennett .
4,989,759	2/1991	Gangloff .
5,186,366	2/1993	Meisner et al. .

Primary Examiner—Terry A. Wallace
Attorney, Agent, or Firm—Nixon & Vanderhye

[57] **CLAIM**

The ornamental design for a dispensing container, as shown and described.

DESCRIPTION

FIG. 1 is a perspective view of a dispensing container showing my new design;
FIG. 2 is a top plan view thereof;
FIG. 3 is a bottom plan view thereof;
FIG. 4 is a front elevation thereof;
FIG. 5 is a rear elevation thereof;
FIG. 6 is a left side elevation view thereof; the right side elevation view being a mirror image thereof; and,
FIG. 7 is a perspective view thereof in an open position.

1 Claim, 5 Drawing Sheets

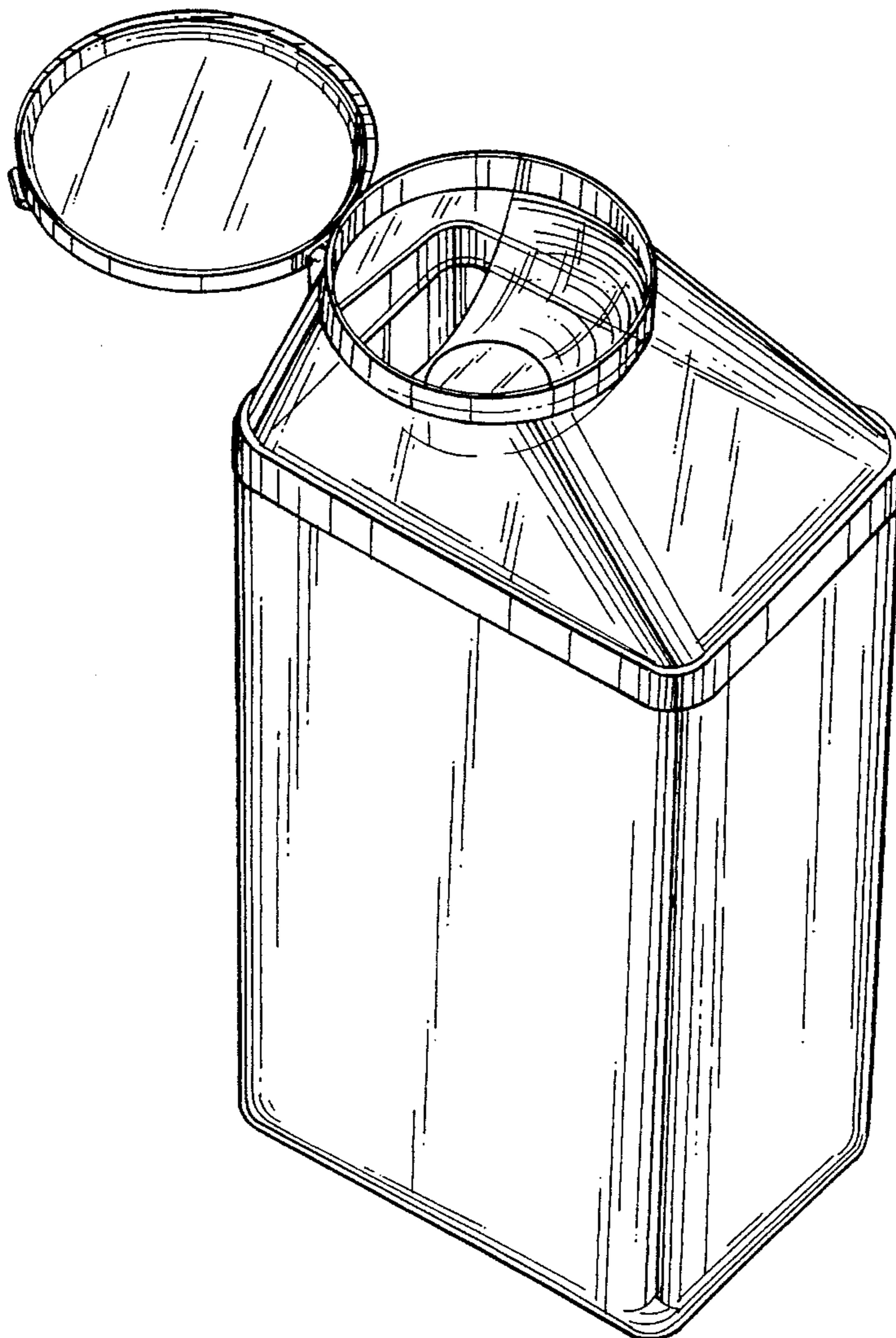
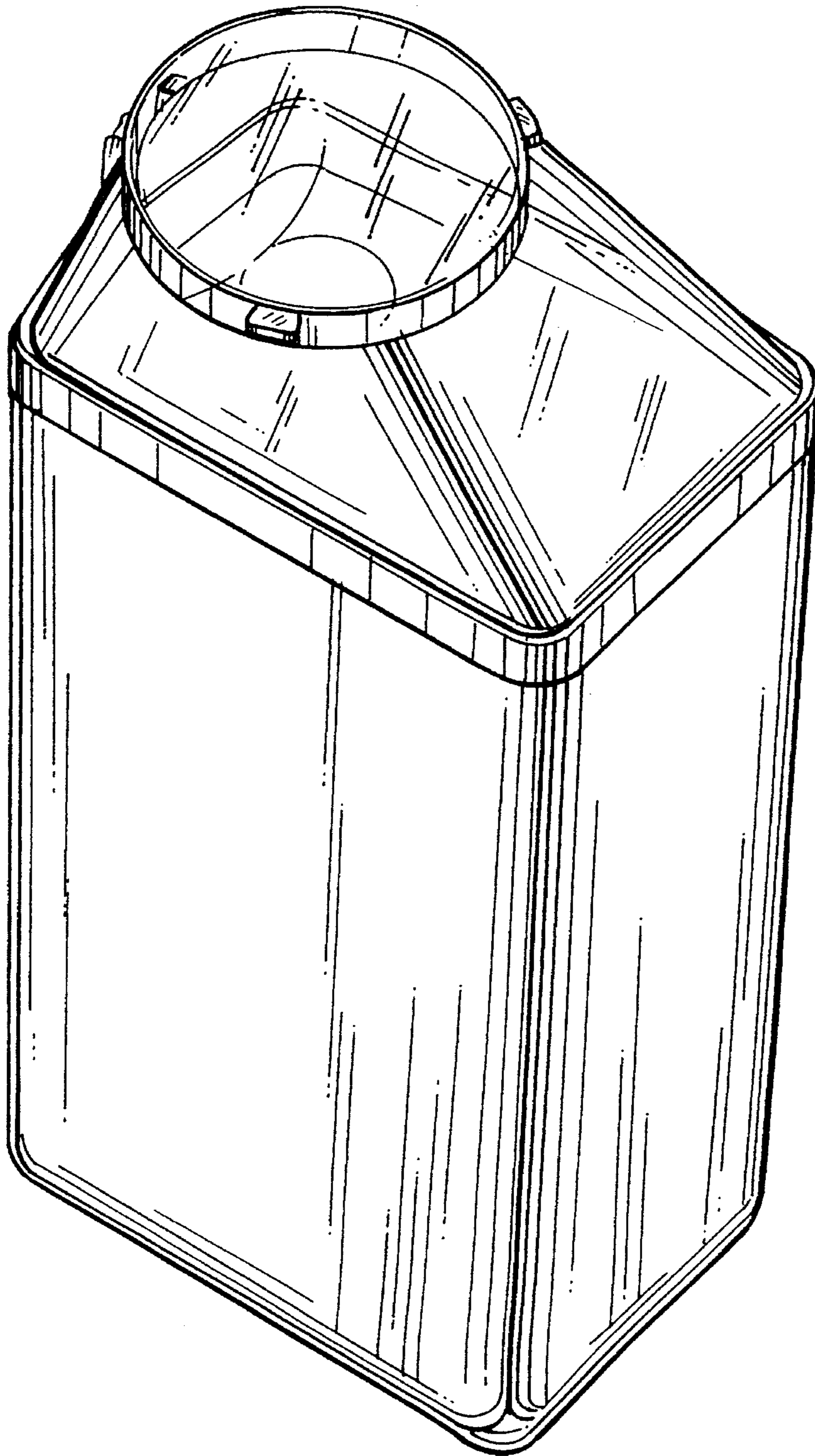

FIG. 1



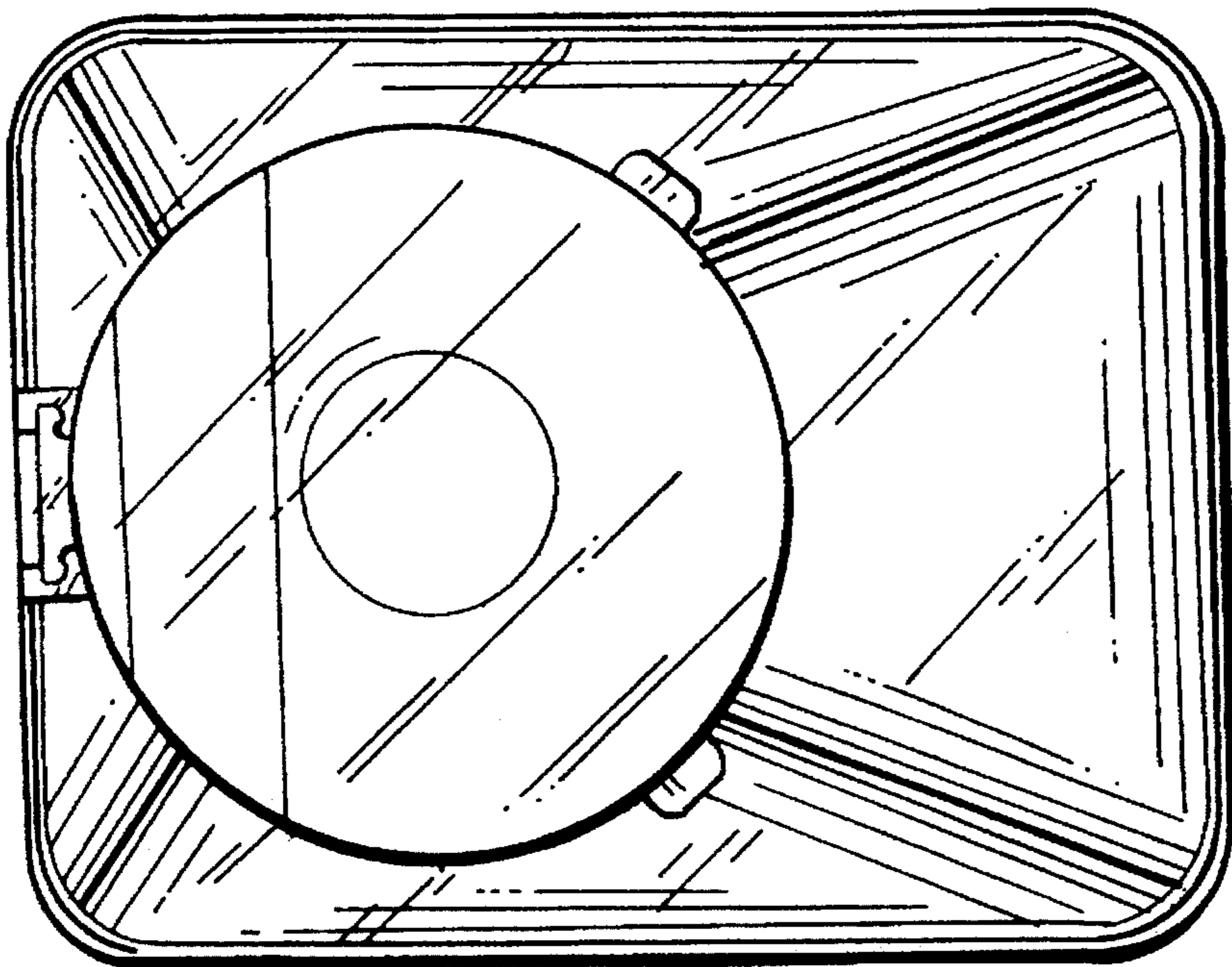

FIG. 2

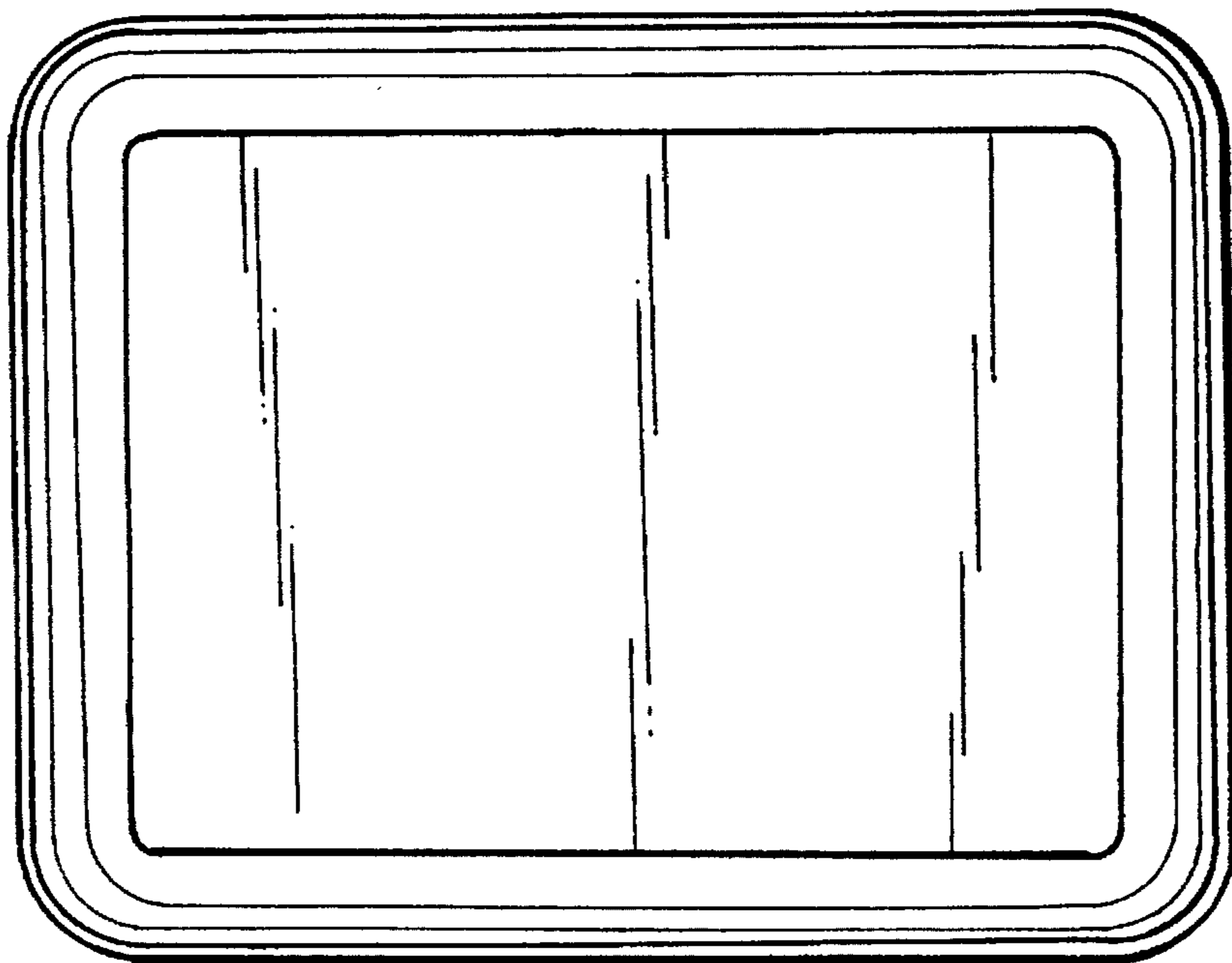

FIG. 3

FIG. 4

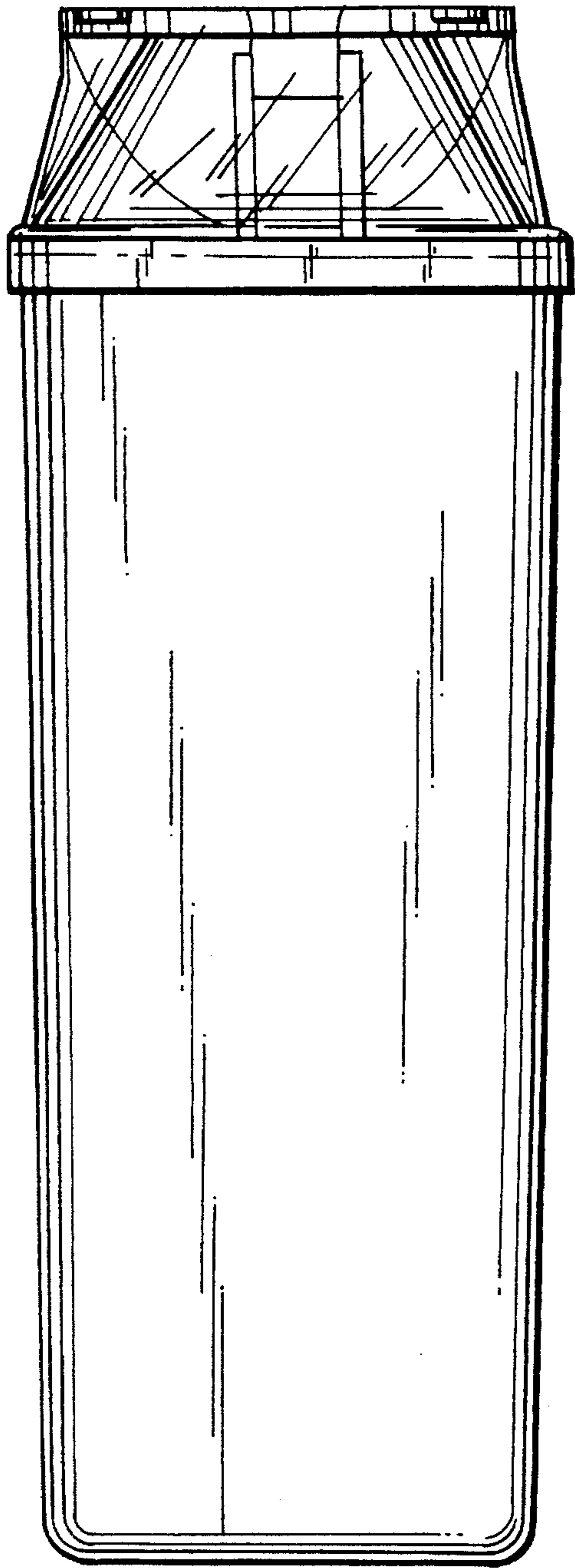

FIG. 5

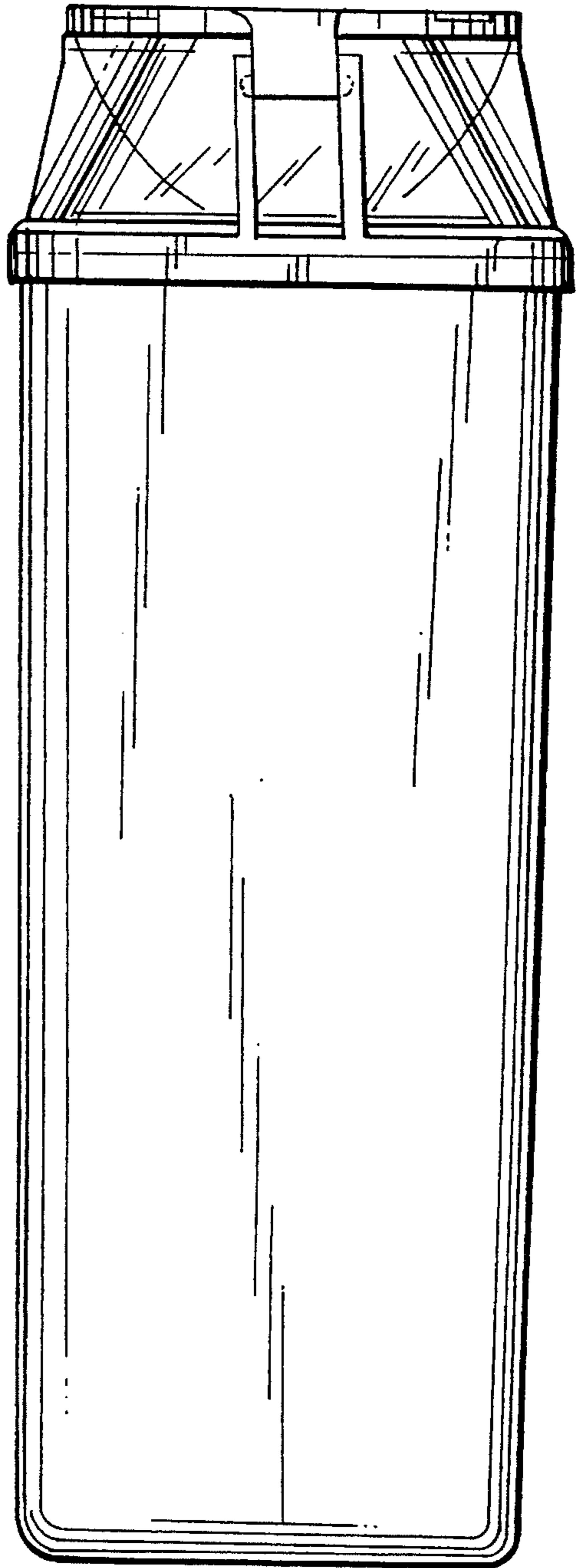

FIG. 6

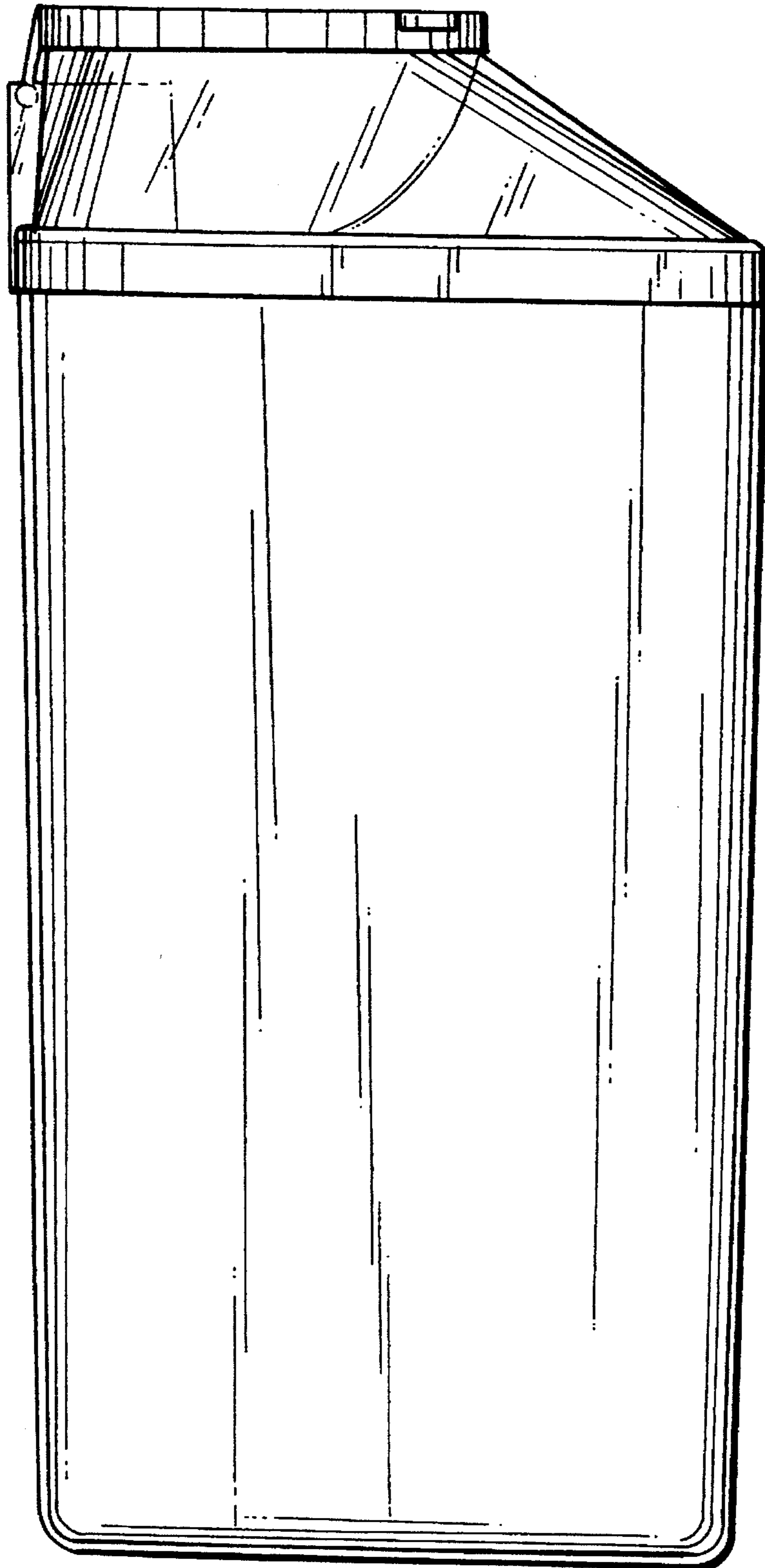

FIG. 7

