



US00D363597S

United States Patent [19] Byrne

[11] Patent Number: **Des. 363,597**

[45] Date of Patent: ***** Oct. 31, 1995**

[54] **SUN AND PRIVACY SCREEN**

4,858,669 8/1989 Vinson 160/134
5,139,070 8/1992 Kidd 160/84.1

[76] Inventor: **Barbara Byrne**, 5748 S. Narragansett,
Chicago, Ill. 60638

FOREIGN PATENT DOCUMENTS

[*] Notice: The portion of the term of this patent
subsequent to Jun. 13, 2009, has been
disclaimed.

565330 3/1958 Belgium .
1256866 2/1961 France 160/134
600852 6/1978 Switzerland 160/134
627698 8/1949 United Kingdom 135/20.1
815405 2/1958 United Kingdom .

[**] Term: **14 Years**

Primary Examiner—Ralf T. Seifert
Attorney, Agent, or Firm—Barlow & Barlow, Ltd.

[21] Appl. No.: **10,539**

[57] CLAIM

[22] Filed: **Jul. 9, 1993**

The ornamental design for a sun and privacy screen, as
shown and described.

Related U.S. Application Data

[63] Continuation-in-part of Ser. No. 8,225, May 12, 1993.
[52] U.S. Cl. **D3/5**
[58] Field of Search D3/1-4, 5; 416/70 R-73;
135/20.1, 902; 160/84.1 F, 134; D12/417,
191

DESCRIPTION

FIG. 1 is a perspective view of a sun and privacy screen in
an opened state showing my new design in which two panels
depend from the horizontally positioned ribs;
FIG. 2 is a front view thereof;
FIG. 3 is a rear view thereof;
FIG. 4 is a right side view thereof;
FIG. 5 is a left side view thereof;
FIG. 6 is a top plan view thereof;
FIG. 7 is a bottom plan view thereof;
FIG. 8 is a perspective view of a sun and privacy screen
showing a second embodiment of my new design, in which
four panels depend from the horizontally positioned ribs;
FIG. 9 is a right side view of the invention shown in FIG. 8;
and,
FIG. 10 is a left side view of the invention shown in FIG. 8.

[56] References Cited

U.S. PATENT DOCUMENTS

D. 93,183 8/1934 Roth D3/5
D. 308,556 6/1990 Spoto D12/191
451,068 4/1891 Park .
873,580 12/1907 McElroy .
1,057,310 3/1913 White .
1,221,595 4/1917 Riggs .
1,609,877 12/1926 Kendall .
2,897,002 7/1959 Yovich 160/134 X
3,298,422 1/1967 Ruiz 160/134 X
3,386,106 6/1968 Clemens .
4,745,960 5/1988 Karp 160/84.1

1 Claim, 7 Drawing Sheets

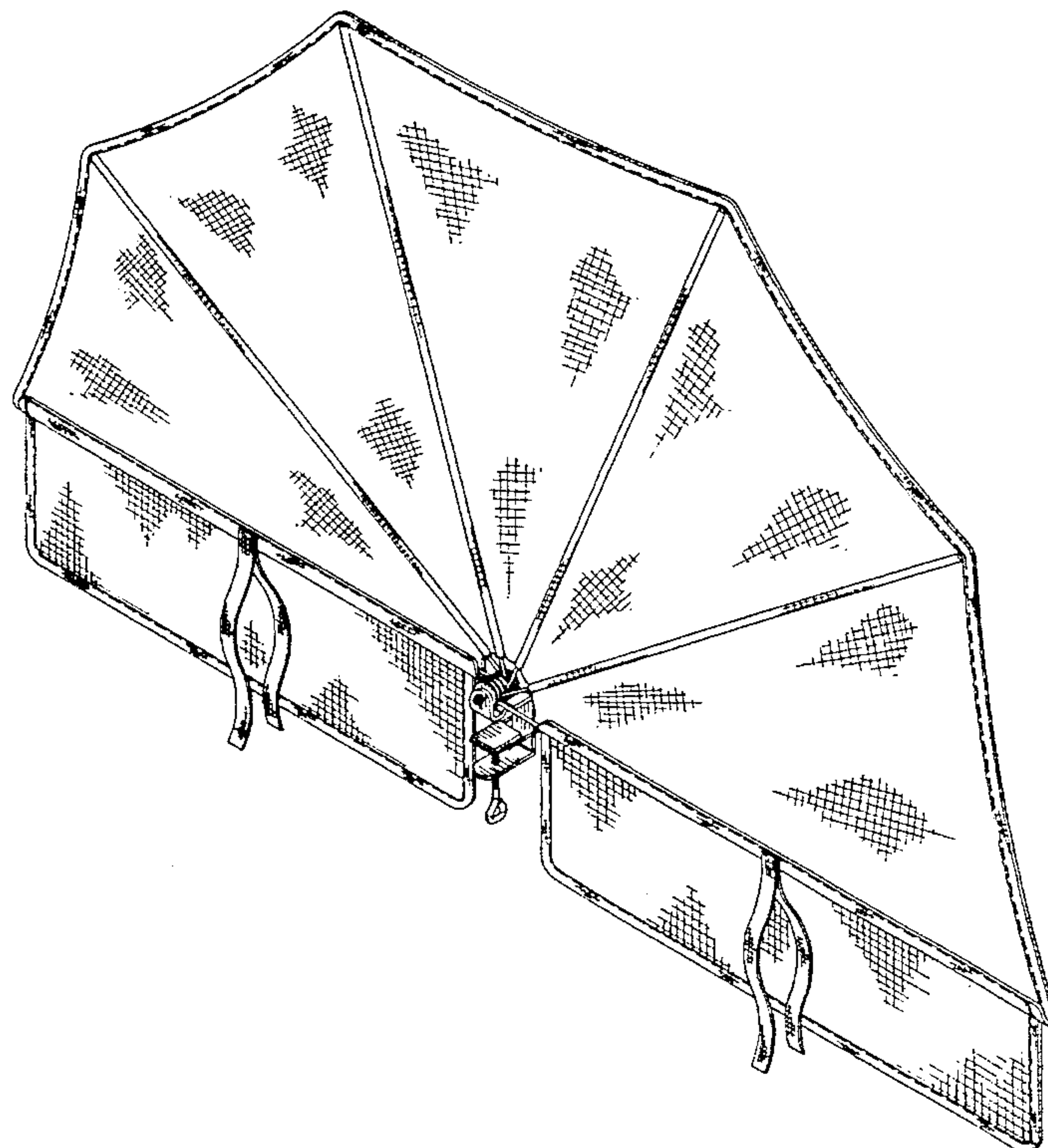

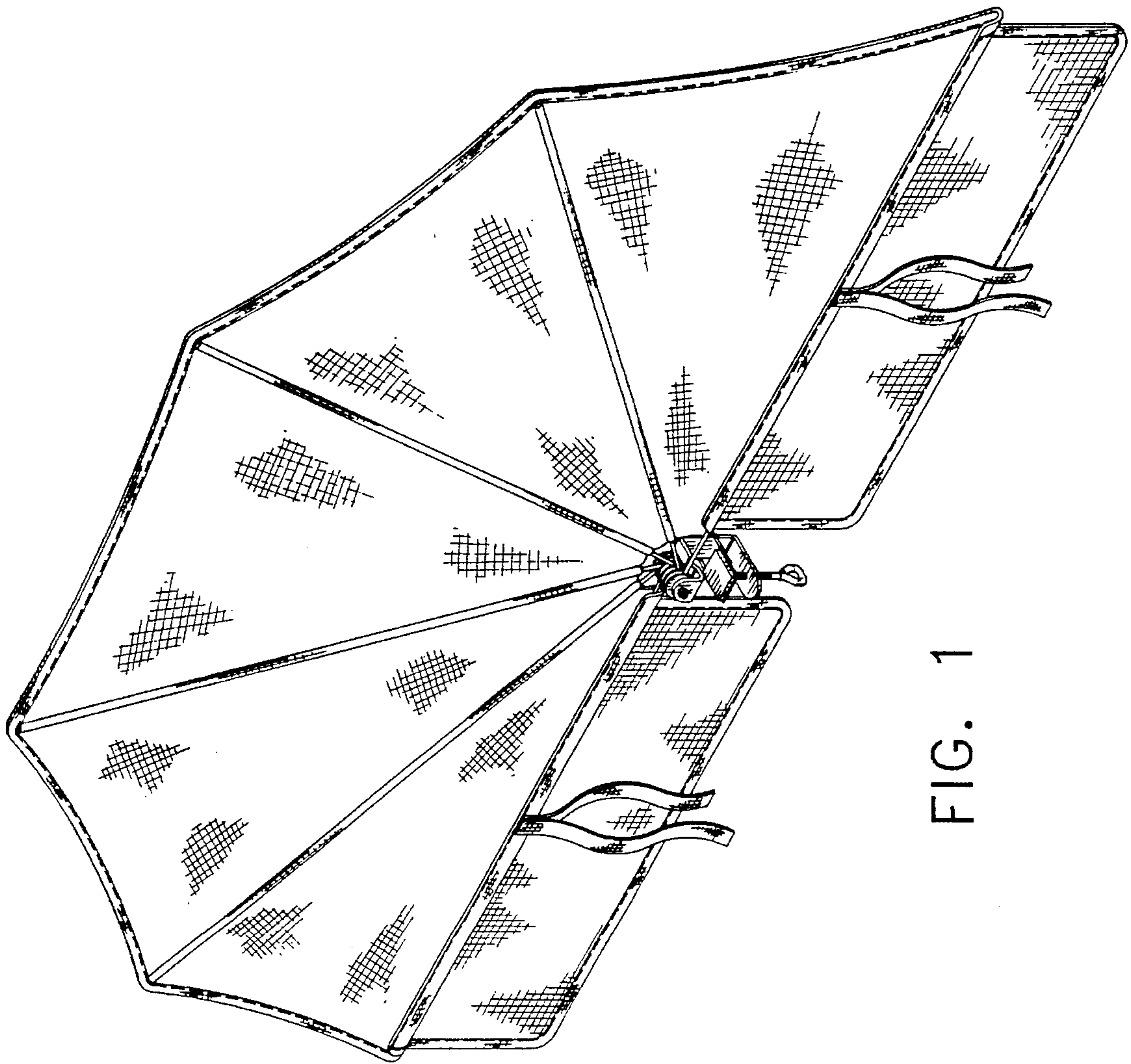

FIG. 1

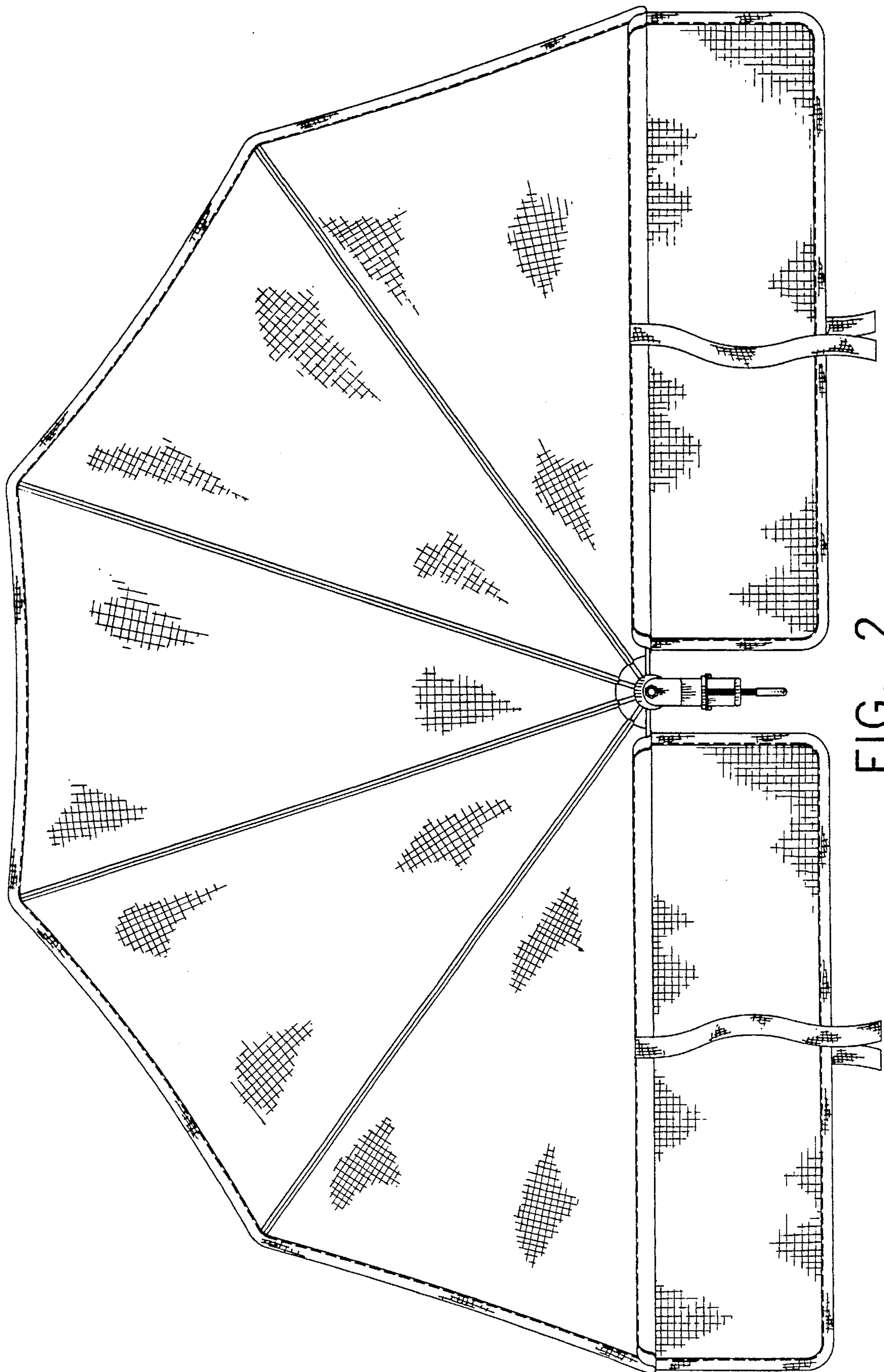

FIG. 2

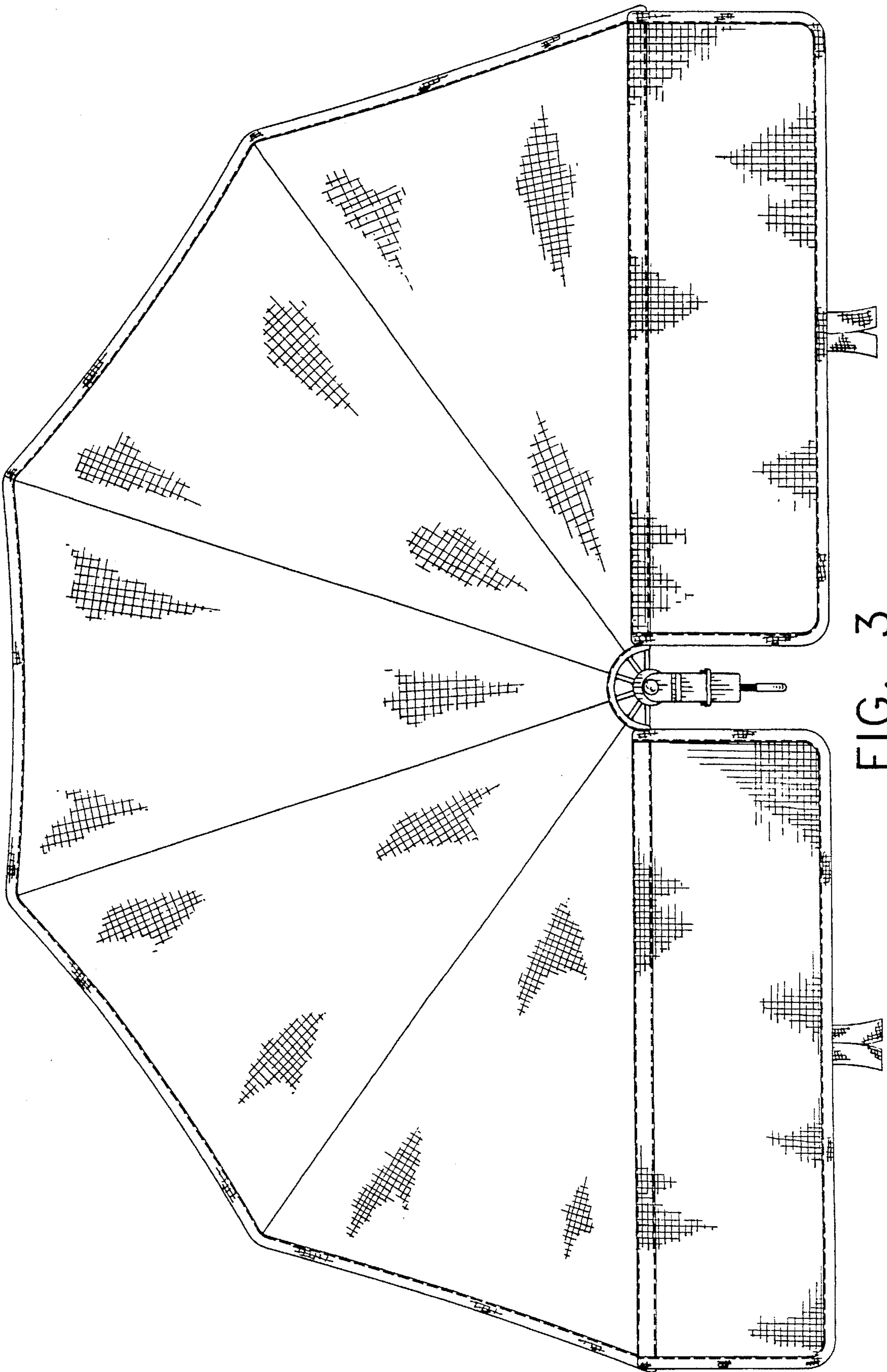

FIG. 3

FIG. 5

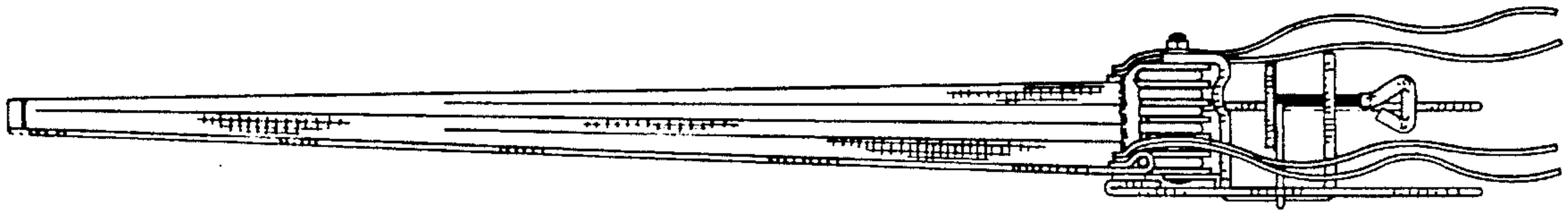
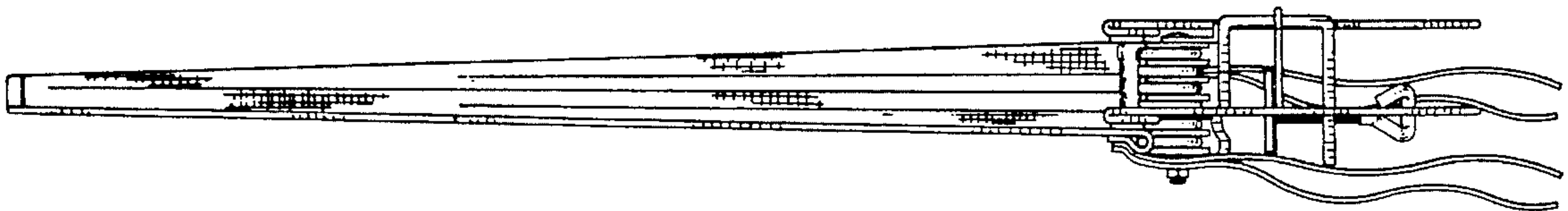

FIG. 4



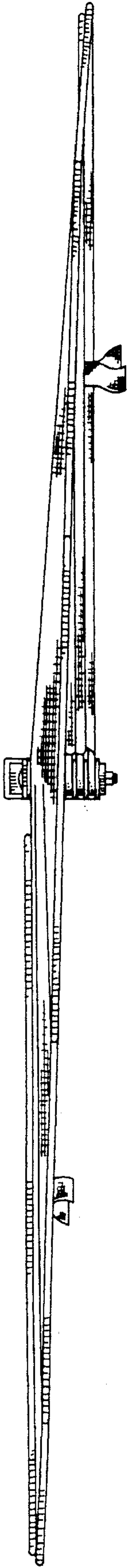

FIG. 6

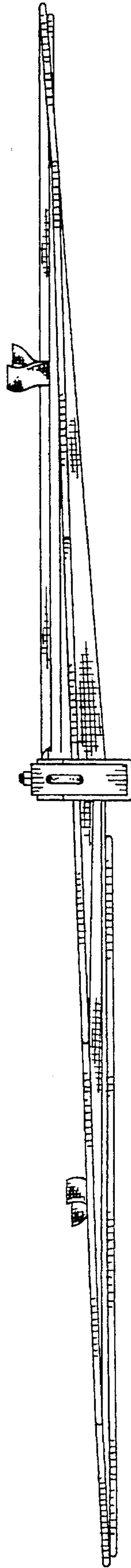

FIG. 7

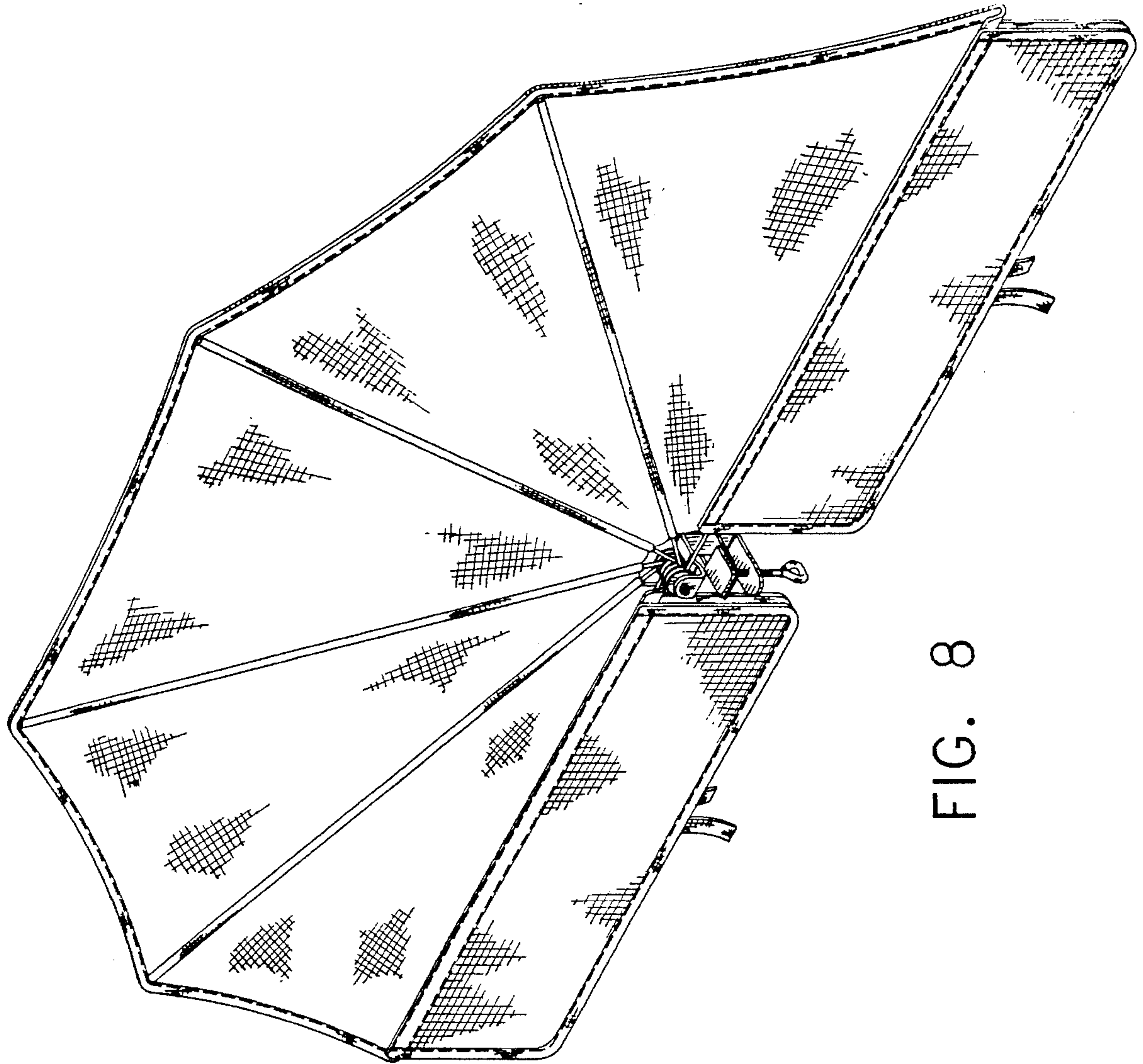

FIG. 8

FIG. 10

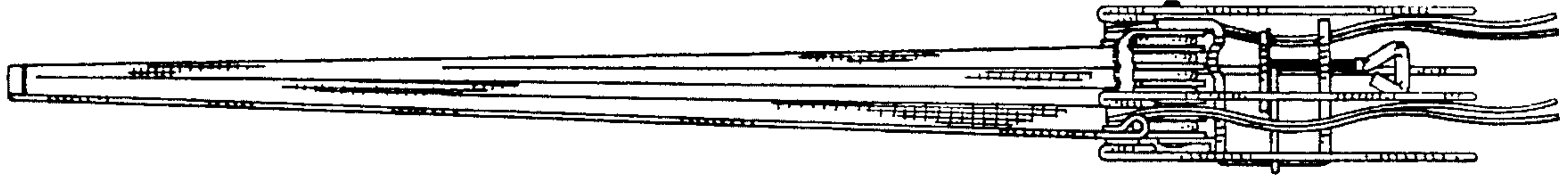

FIG. 9

