



US00D363579S

United States Patent [19]

Scaglione et al.

[11] Patent Number: **Des. 363,579**

[45] Date of Patent: ****Oct. 24, 1995**

[54] **CLIP TO HOLD A PAIR OF SOCKS, THROUGH WASH AND DRY CYCLE AND FOR STORAGE**

[76] Inventors: **Alfred Scaglione; Joanne Scaglione**, both of 22450 Martha St., Woodland Hills, Calif. 91367; **George Sanchez**, 19147 Kinzie St., Northridge, Calif. 91324; **Bernardo Baran**, 22821 Sparrow Dell Dr., Calabasas, Calif. 91302

[**] Term: **14 Years**

[21] Appl. No.: **25,598**

[22] Filed: **Jul. 6, 1994**

[52] U.S. Cl. **D32/61**

[58] Field of Search D8/395, 388; D19/65; D11/200-201; 24/30.5 R, 662, 664, DIG. 29, DIG. 21, 137 A, 138 R; D32/61

[56] **References Cited**

U.S. PATENT DOCUMENTS

D. 206,786	1/1967	McCormick	D19/65
D. 257,046	9/1980	Olsson	D19/65
D. 257,158	9/1980	Olsson	D19/65
D. 298,976	12/1988	Moore, Jr.	D32/61
D. 303,216	9/1989	Hoffman et al.	D19/65

D. 311,078	10/1990	Holladay et al.	D32/61
D. 327,149	6/1992	Harper IV	D8/395
D. 348,902	7/1994	Beyer	D8/395
D. 350,985	9/1994	Schimke	D19/65
3,346,927	10/1967	Tompkins	24/DIG. 29 X
4,045,844	9/1977	Murry	24/DIG. 29 X

Primary Examiner—Ralf T. Seifert

[57] **CLAIM**

The ornamental design for a clip to hold a pair of socks, through wash and dry cycle and for storage, as shown and described.

DESCRIPTION

FIG. 1 is a top front perspective view of a clip to hold a pair of socks, through wash and dry cycle and for storage showing my new design;

FIG. 2 is a top plan view shown reduced in size;

FIG. 3 is a bottom plan view of FIG. 2;

FIG. 4 is a side elevational of FIG. 2;

FIG. 5 is a right side elevational view of FIG. 2;

FIG. 6 is a front elevational view of FIG. 2;

FIG. 7 is a rear elevational view of FIG. 2;

FIG. 8 is a perspective view shown in a closed position, the broken line showing of material is for illustrative purposes only and forms no part of the claimed design.

1 Claim, 3 Drawing Sheets

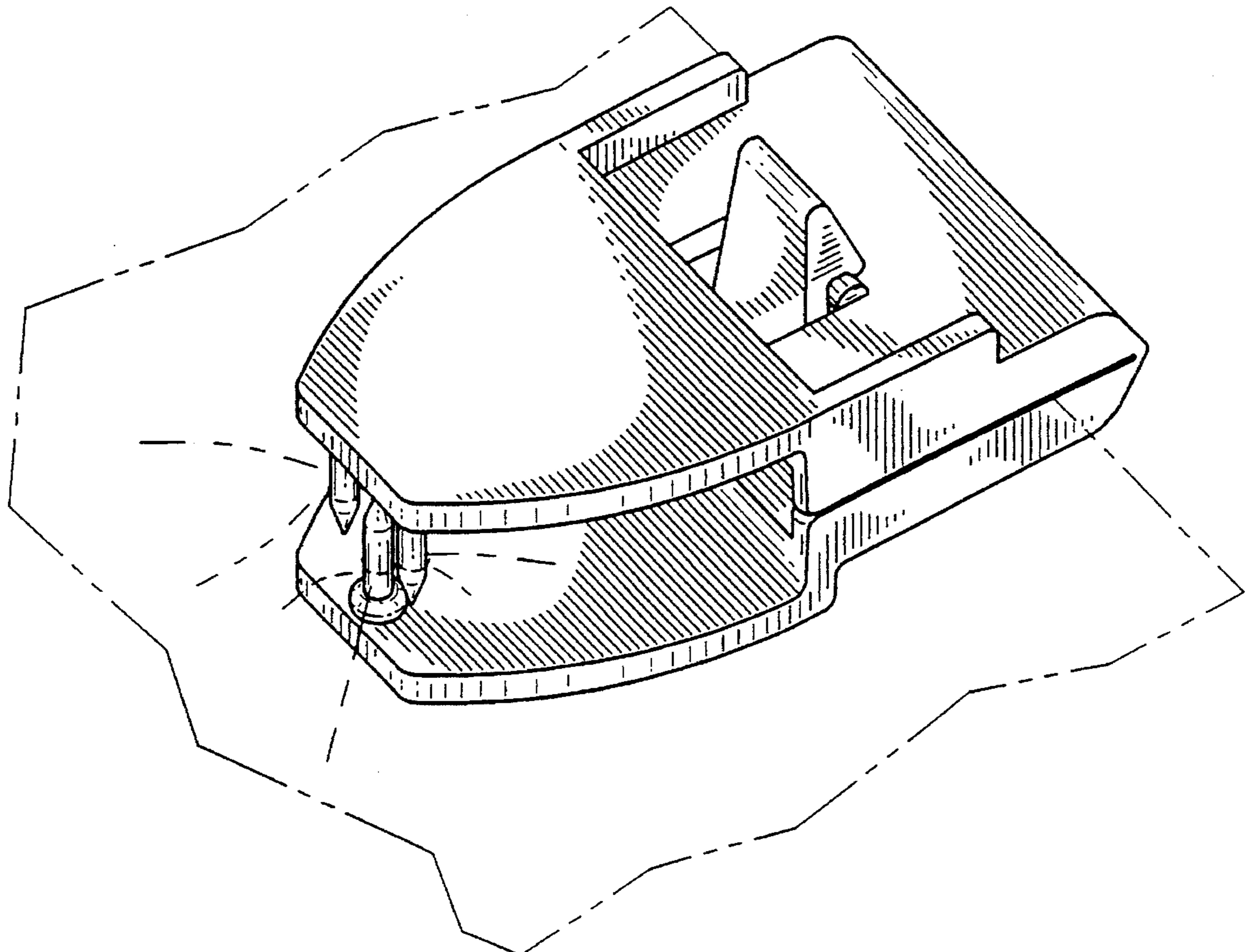

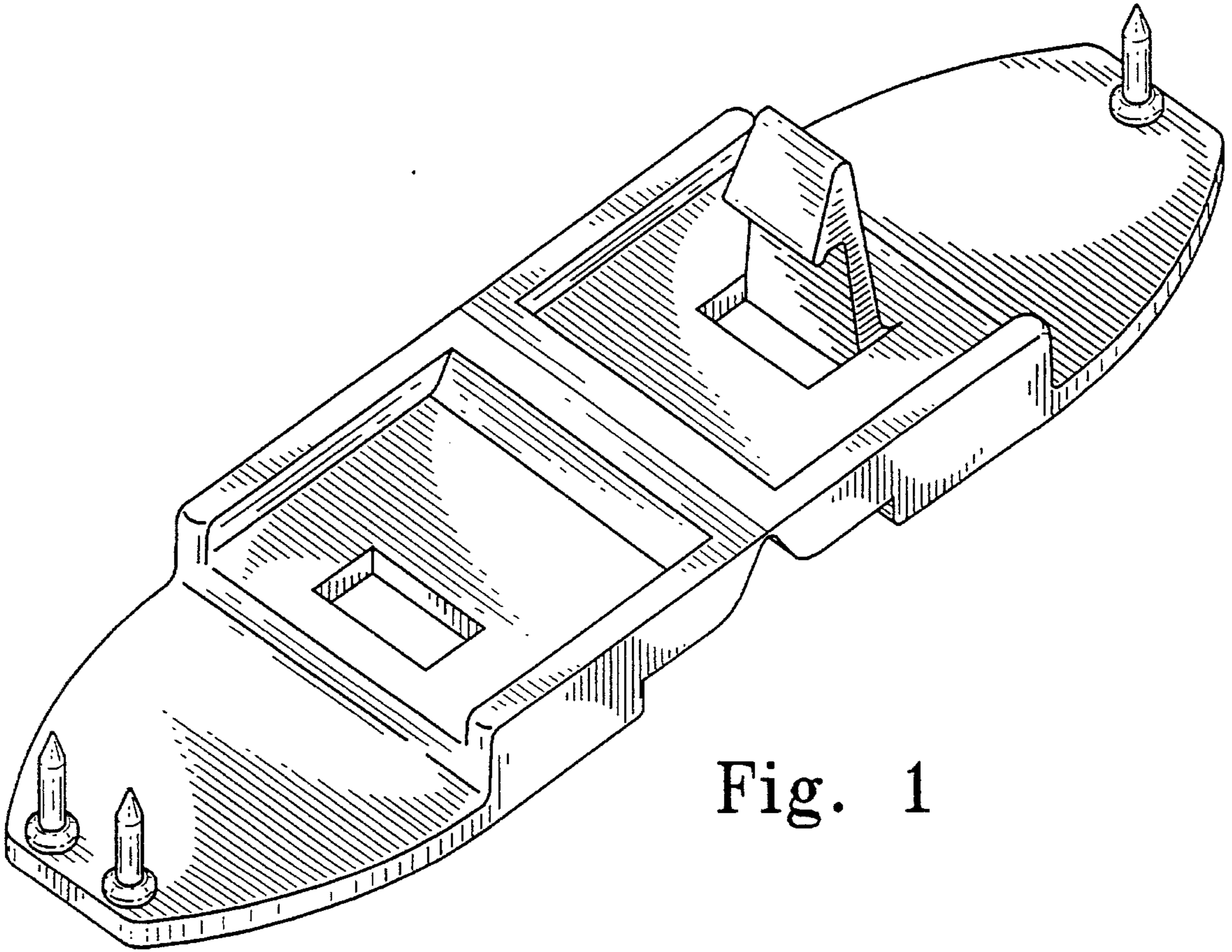

Fig. 1

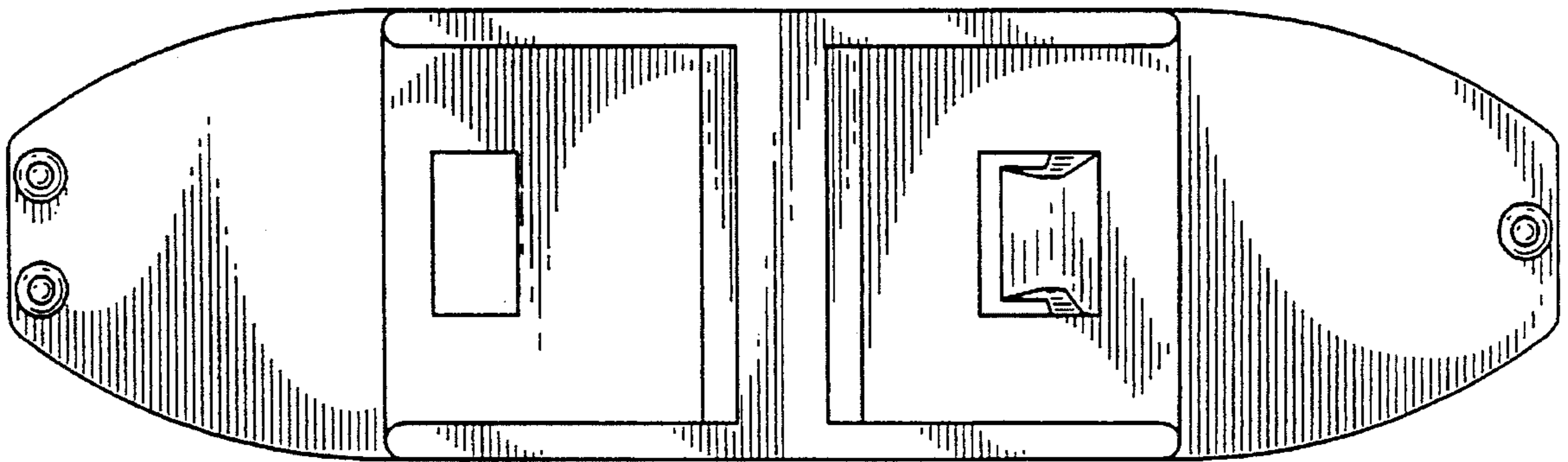

Fig. 2

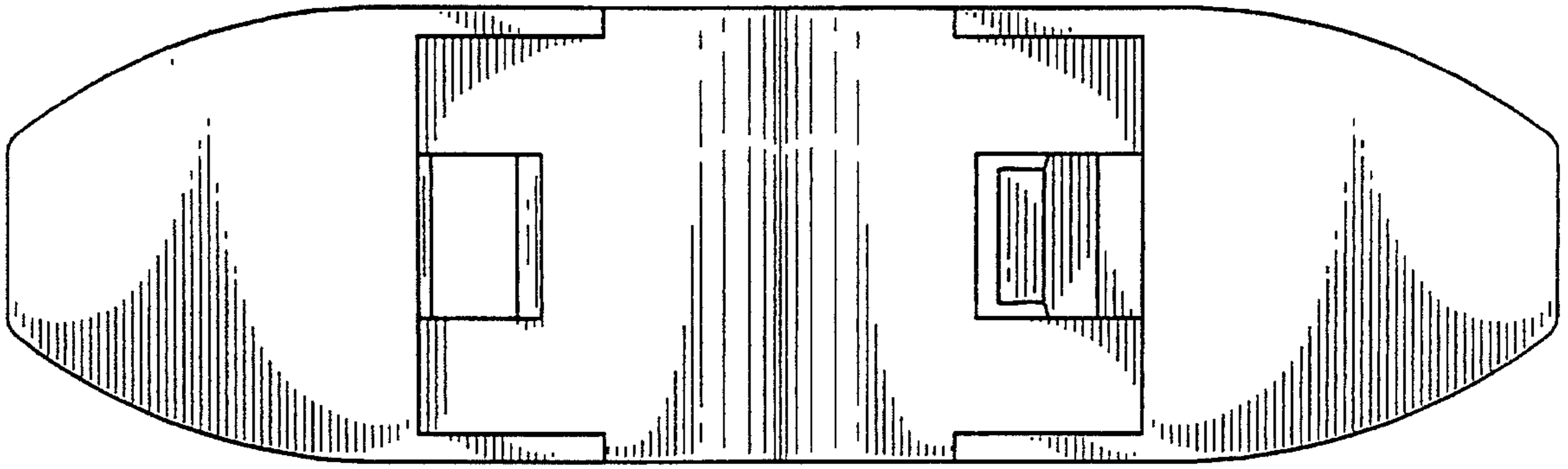

Fig. 3

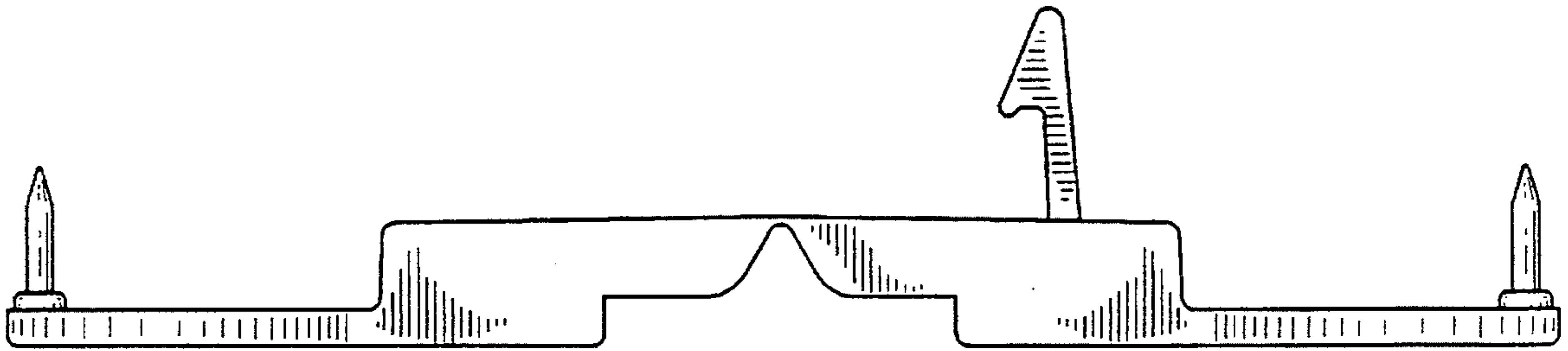

Fig. 4

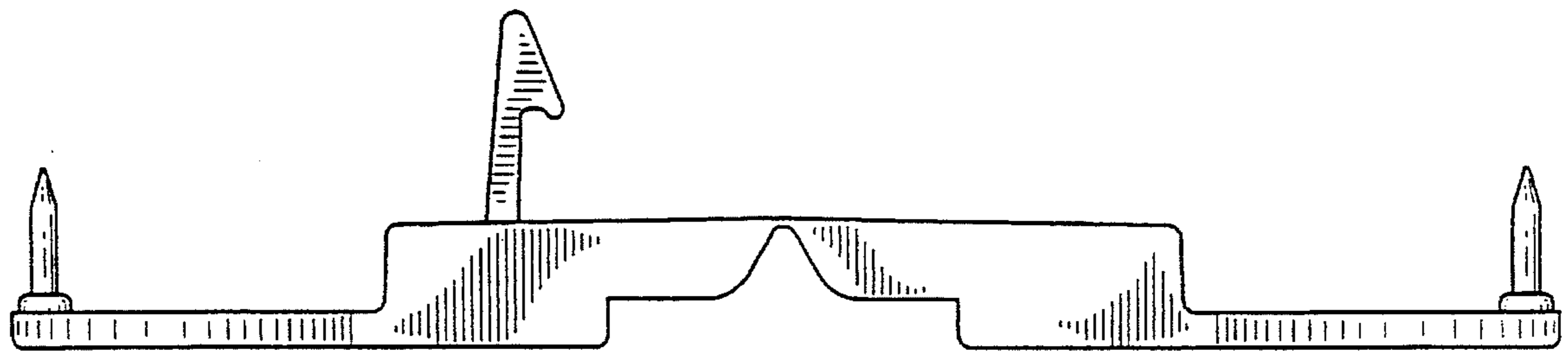

Fig. 5

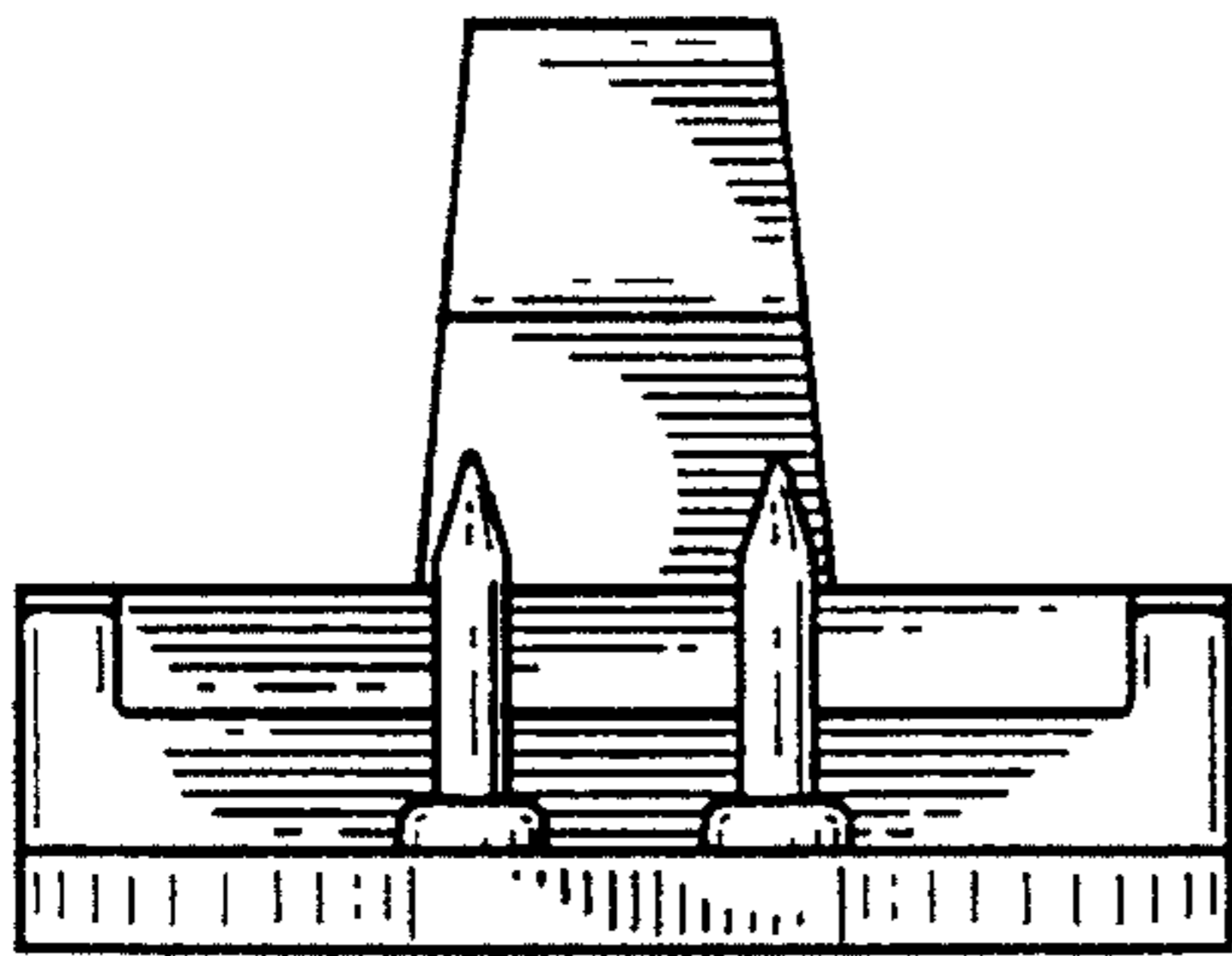

Fig. 6

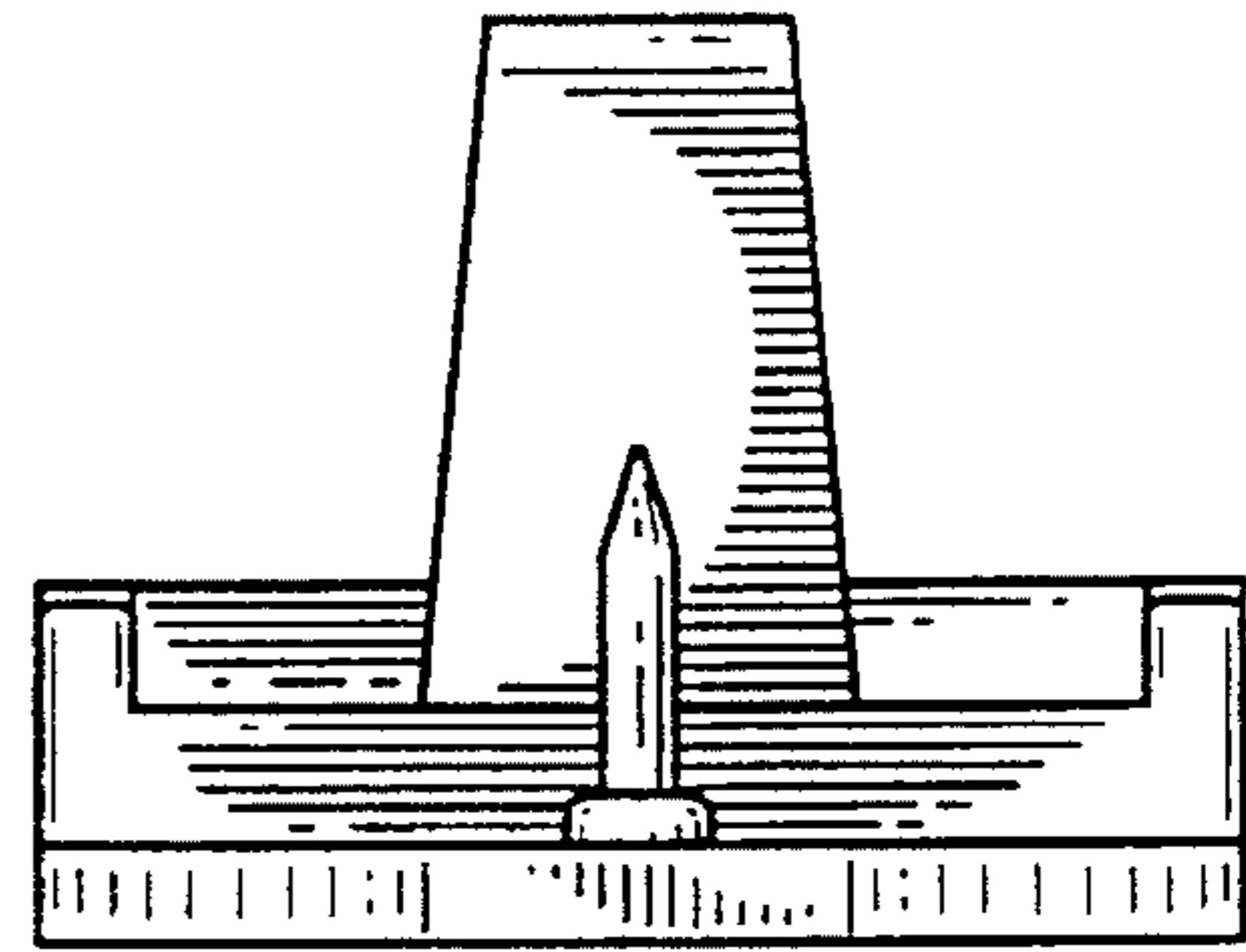

Fig. 7

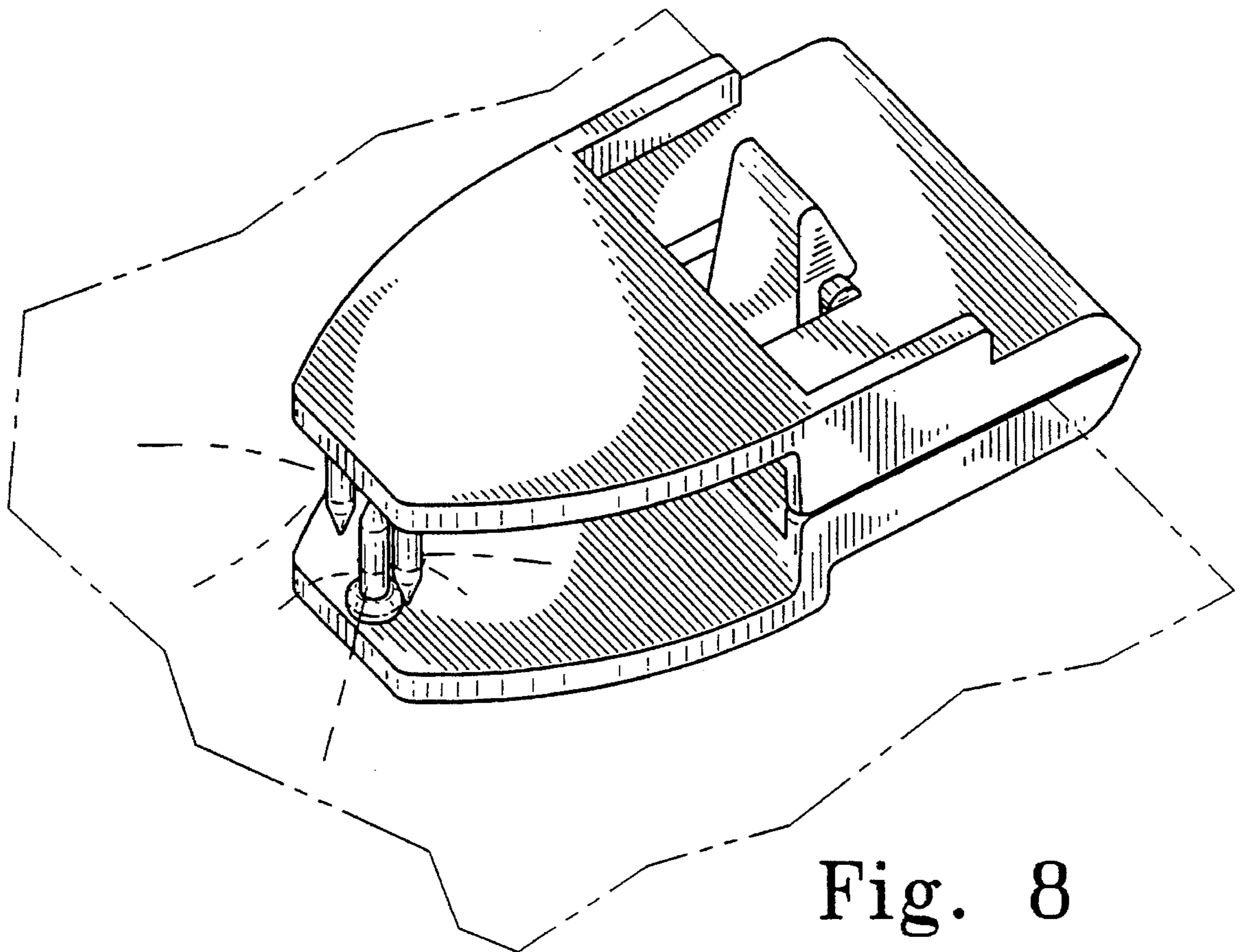

Fig. 8