



US00D363573S

# United States Patent [19]

[11] Patent Number: **Des. 363,573**

**Rehn**

[45] Date of Patent: **\*\*Oct. 24, 1995**

[54] **DOG DISH**

[76] Inventor: **Rodney Rehn**, 4018 Faultless St.,  
Dallas, Tex. 75211

[\*\*] Term: **14 Years**

D. 343,929	2/1994	Karapetian .....	D30/130
D. 353,519	12/1994	Wolfenden .....	D7/584
2,529,354	11/1950	Schraeder .....	D30/130
2,813,509	11/1957	Bruno .....	119/51.5
3,734,062	5/1973	O'Hara .....	D30/130
4,395,015	7/1983	Reardon .....	D30/130

[21] Appl. No.: **25,969**

[22] Filed: **Jul. 15, 1994**

[52] U.S. Cl. .... **D30/130; D7/543; D7/555**

[58] Field of Search ..... D30/121, 129-130,  
D30/131-133; D7/502, 507, 551, 553-556,  
558, 584, 543, 504; 119/61, 51.5; D21/252;  
D23/277-278, 280.1; D24/204

*Primary Examiner*—Cathy Anne MacCormac

### [57] CLAIM

The ornamental design for a dog dish, as shown and described.

### DESCRIPTION

FIG. 1 is a front elevational view of the dog dish showing my new design;

FIG. 2 is a rear elevational view thereof;

FIG. 3 is a left side elevational view thereof;

FIG. 4 is a right side elevational view thereof;

FIG. 5 is a top plan view thereof;

FIG. 6 is a bottom plan view thereof; and,

FIG. 7 is a perspective view thereof.

### [56] References Cited

#### U.S. PATENT DOCUMENTS

D. 105,812	8/1937	Siekert .....	D30/130
D. 294,531	3/1988	Neunzig .....	D30/130
D. 304,659	11/1989	Asner .....	D7/555
D. 325,684	4/1992	Deare .....	D30/129
D. 326,587	6/1992	Convertini .....	D30/129

**1 Claim, 4 Drawing Sheets**

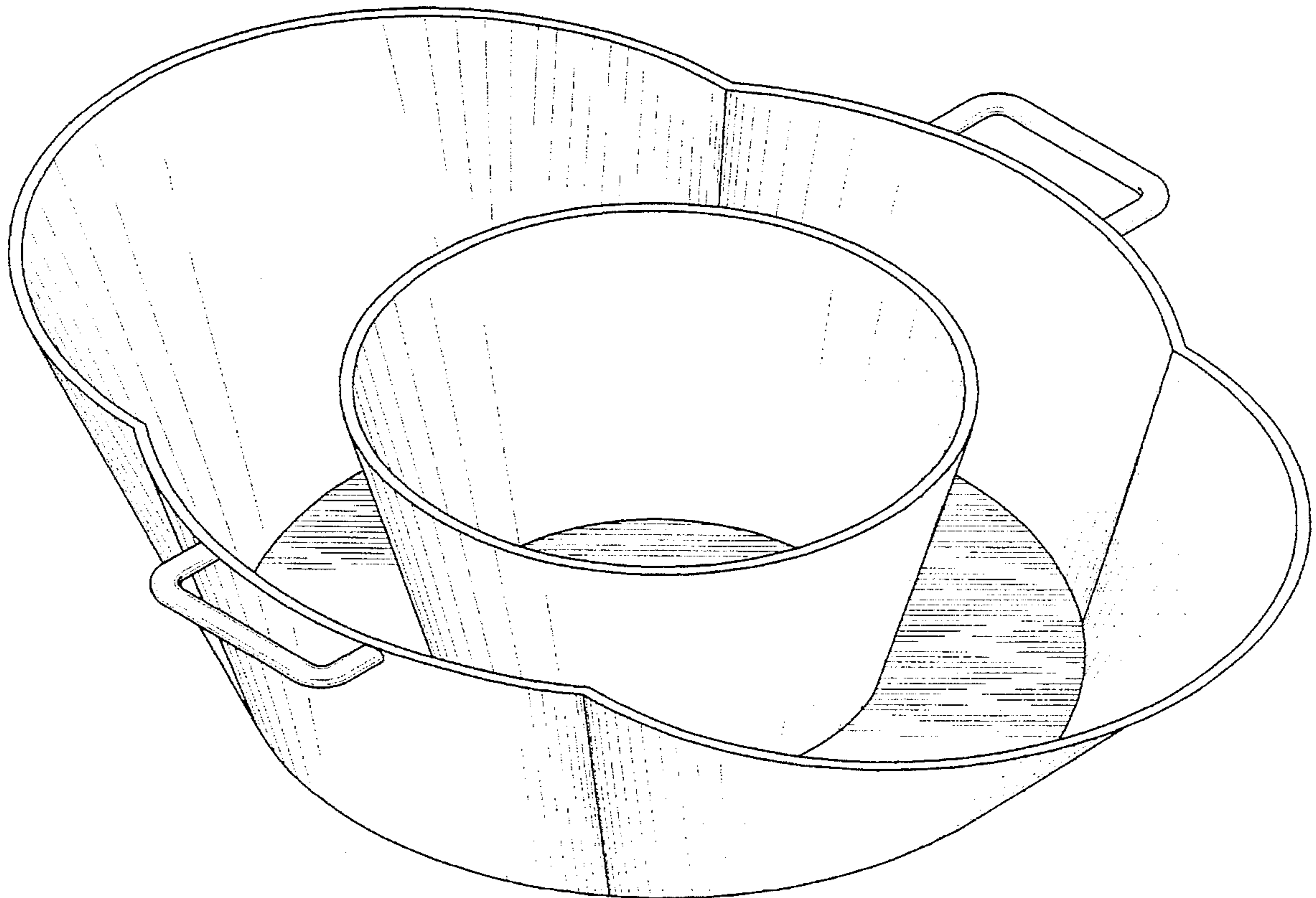

FIG. 1

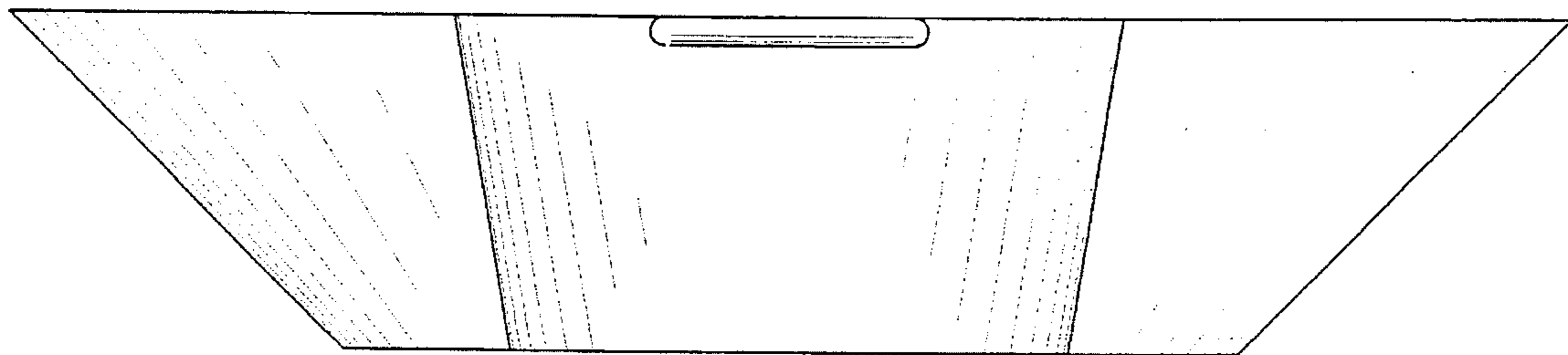

FIG. 2

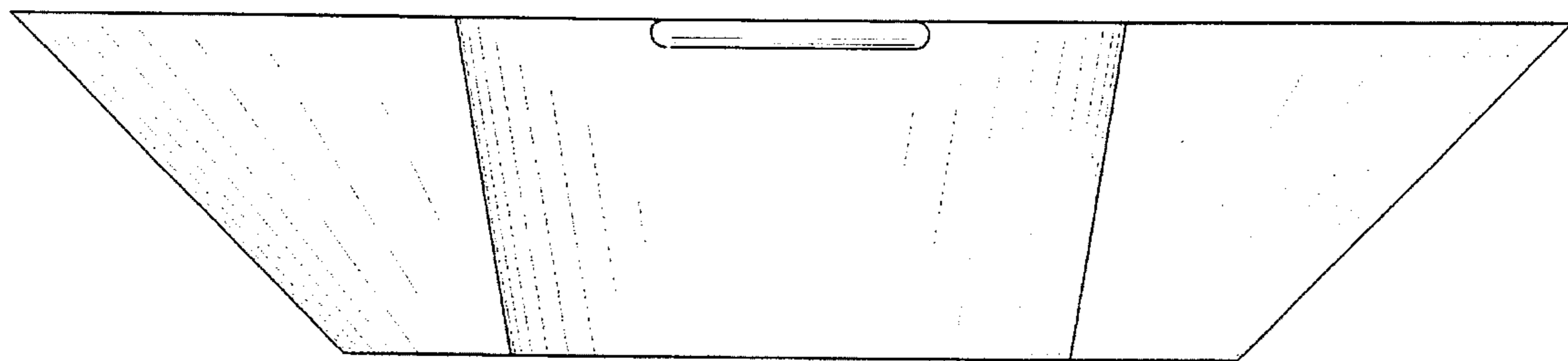

FIG. 3

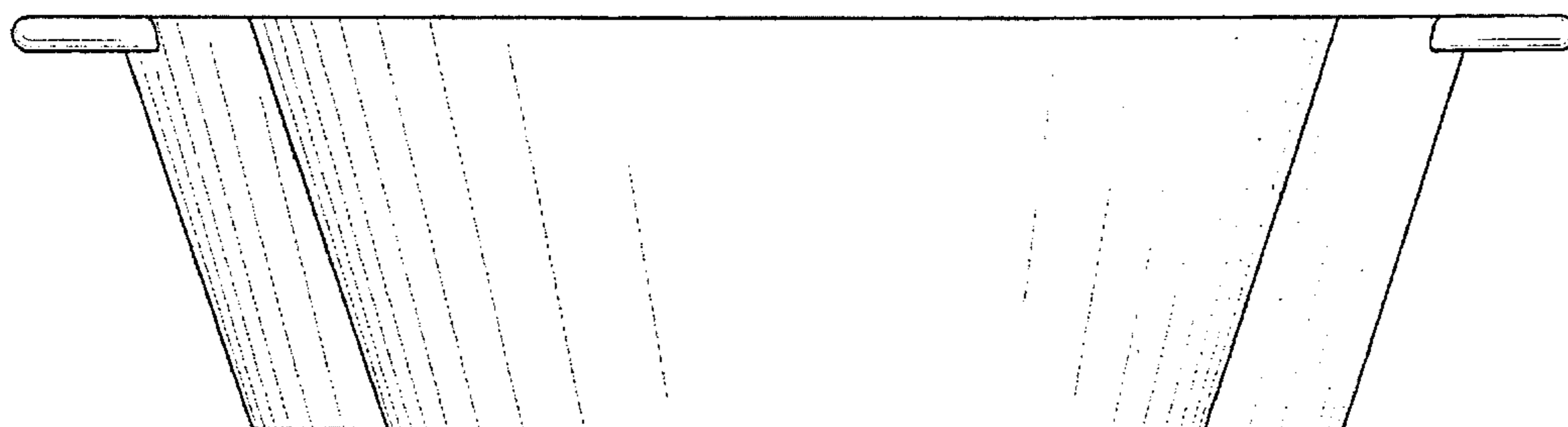

FIG. 4

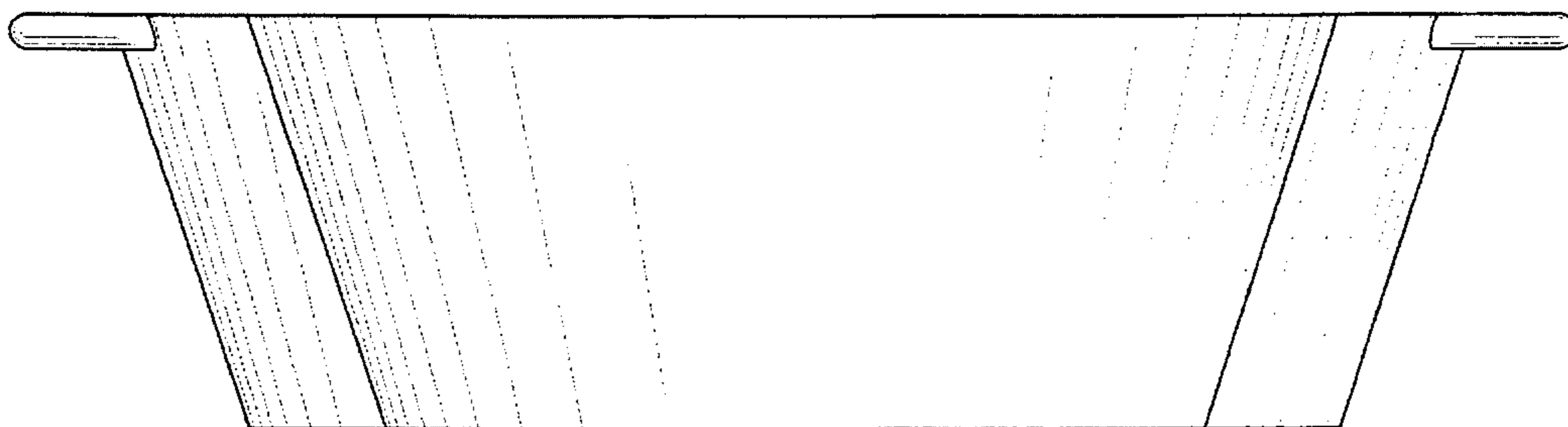

FIG. 5

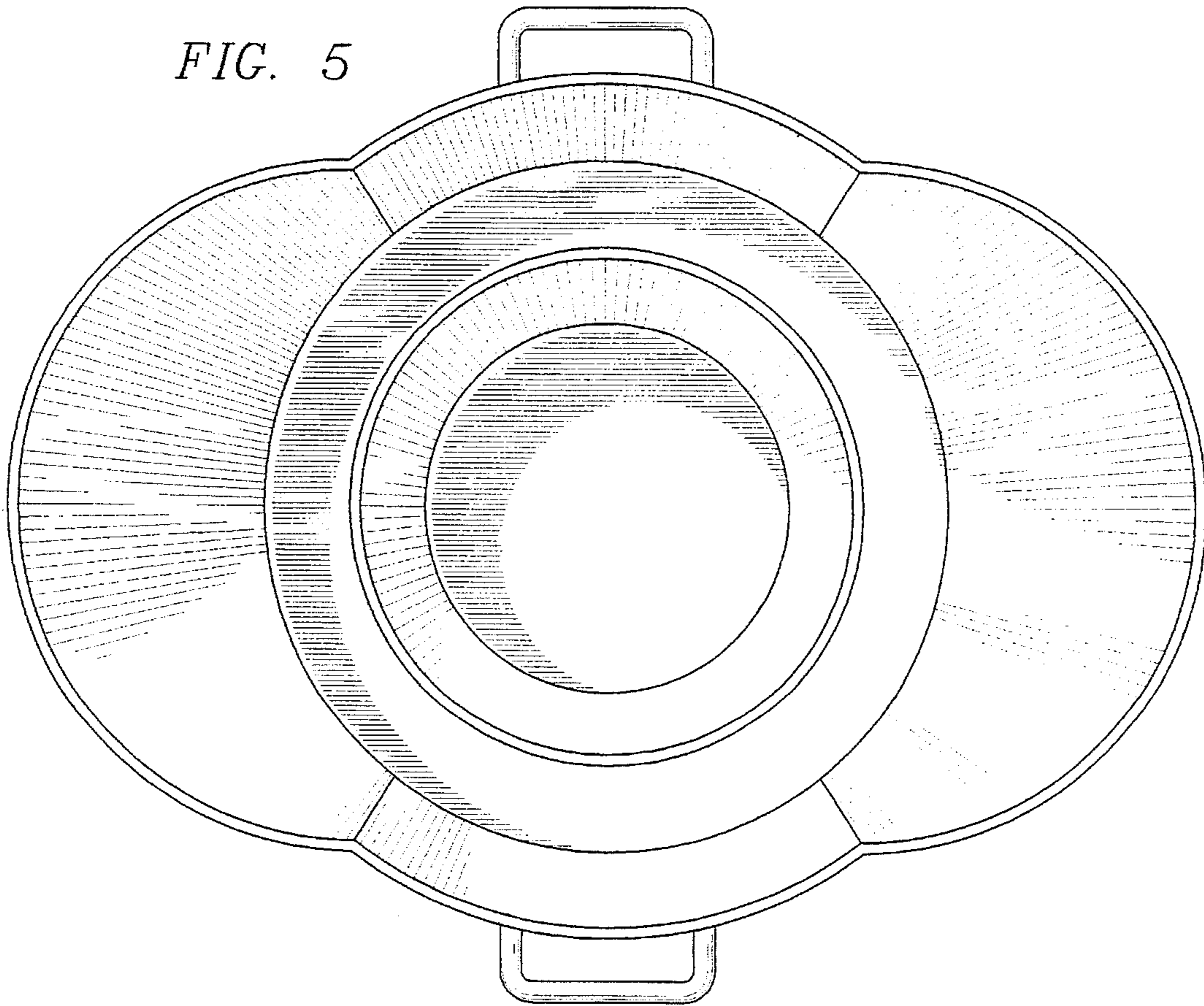

FIG. 6

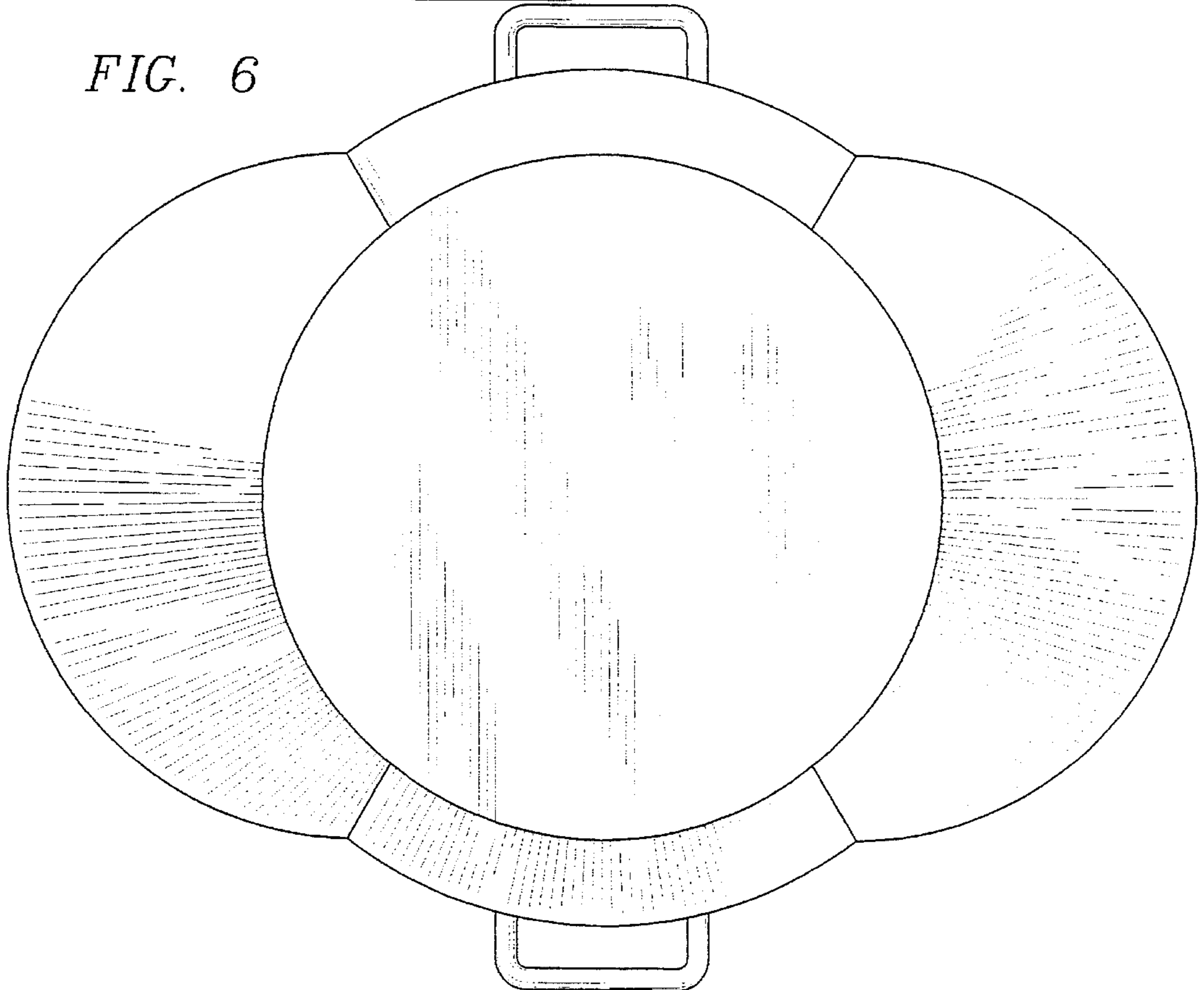

FIG. 7

