



US00D363556S

United States Patent [19]

Katsunuma et al.

[11] Patent Number: **Des. 363,556**

[45] Date of Patent: ****Oct. 24, 1995**

[54] **SOLE MASSAGER**

D. 345,804 4/1994 Chin-Chi D24/213

[75] Inventors: **Tatsuo Katsunuma; Tomio Fujikawa; Seiya Mabuchi**, all of Kashiwa, Japan

Primary Examiner—Stella Reid
Attorney, Agent, or Firm—Flynn, Thiel, Boutell & Tanis

[73] Assignee: **Biopit Co., Ltd.**, Kashiwa, Japan

[57] **CLAIM**

[**] Term: **14 Years**

The ornamental design for a sole massager, as shown and described.

[21] Appl. No.: **28,799**

DESCRIPTION

[22] Filed: **Sep. 22, 1994**

[52] U.S. Cl. **D24/213**

[58] Field of Search D24/212, 213,
D24/200; 601/27, 28, 29, 103, 104

FIG. 1 is a perspective view of a sole massager embodying our new design;

FIG. 2 is a front view thereof;

FIG. 3 is a rear view thereof;

FIG. 4 is a top view thereof;

FIG. 5 is a bottom view thereof;

FIG. 6 is a right side view thereof, the left side view being a mirror image thereof; and,

FIG. 7 is a cross-sectional view thereof, taken along line 7—7 of FIG. 2.

[56] **References Cited**

U.S. PATENT DOCUMENTS

- D. 269,636 7/1983 MacGregor et al. D24/212
- D. 280,934 10/1985 MacGregor D24/212
- D. 330,256 10/1992 Wollman D24/213
- D. 339,638 9/1993 Bucher D24/213 X

1 Claim, 5 Drawing Sheets

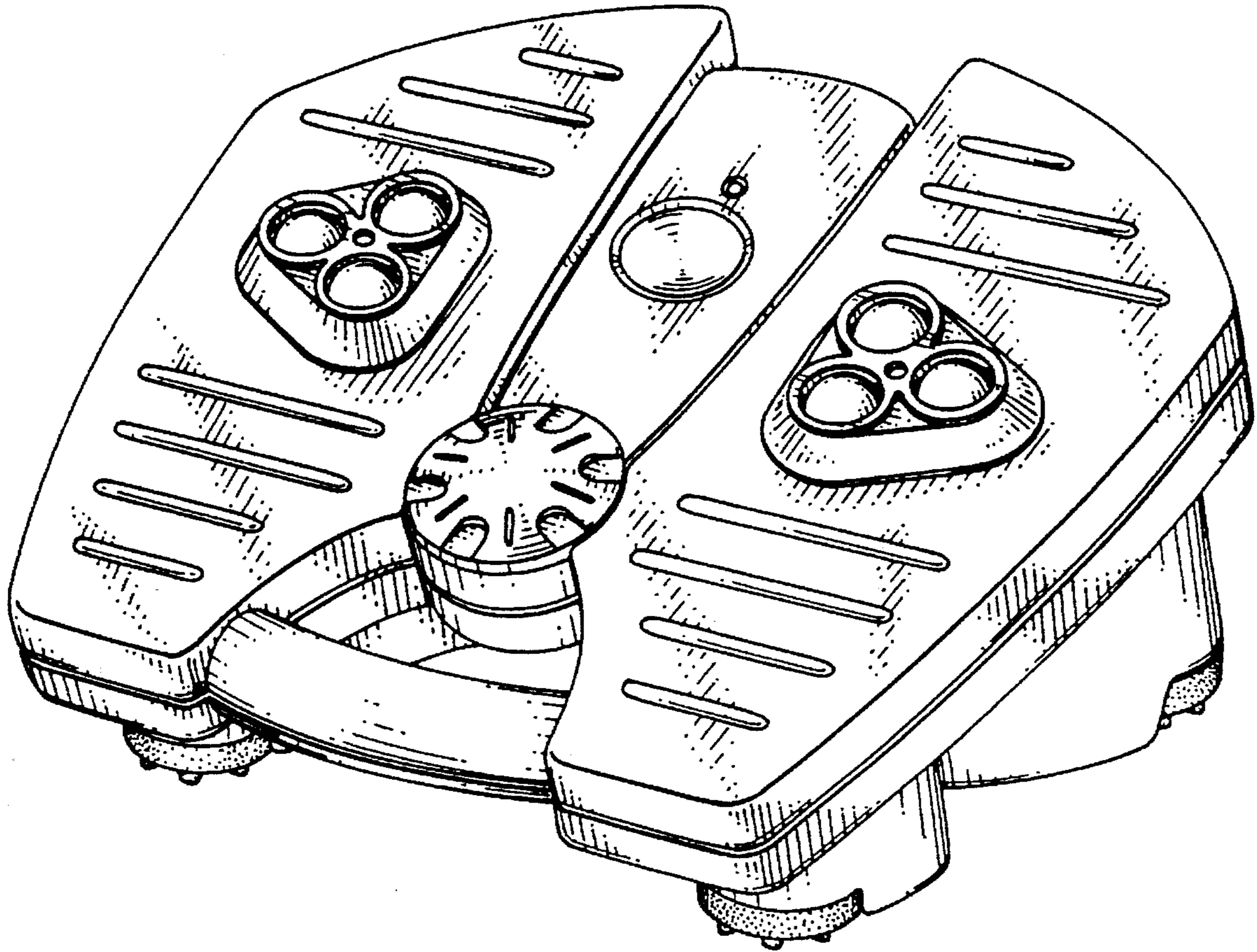

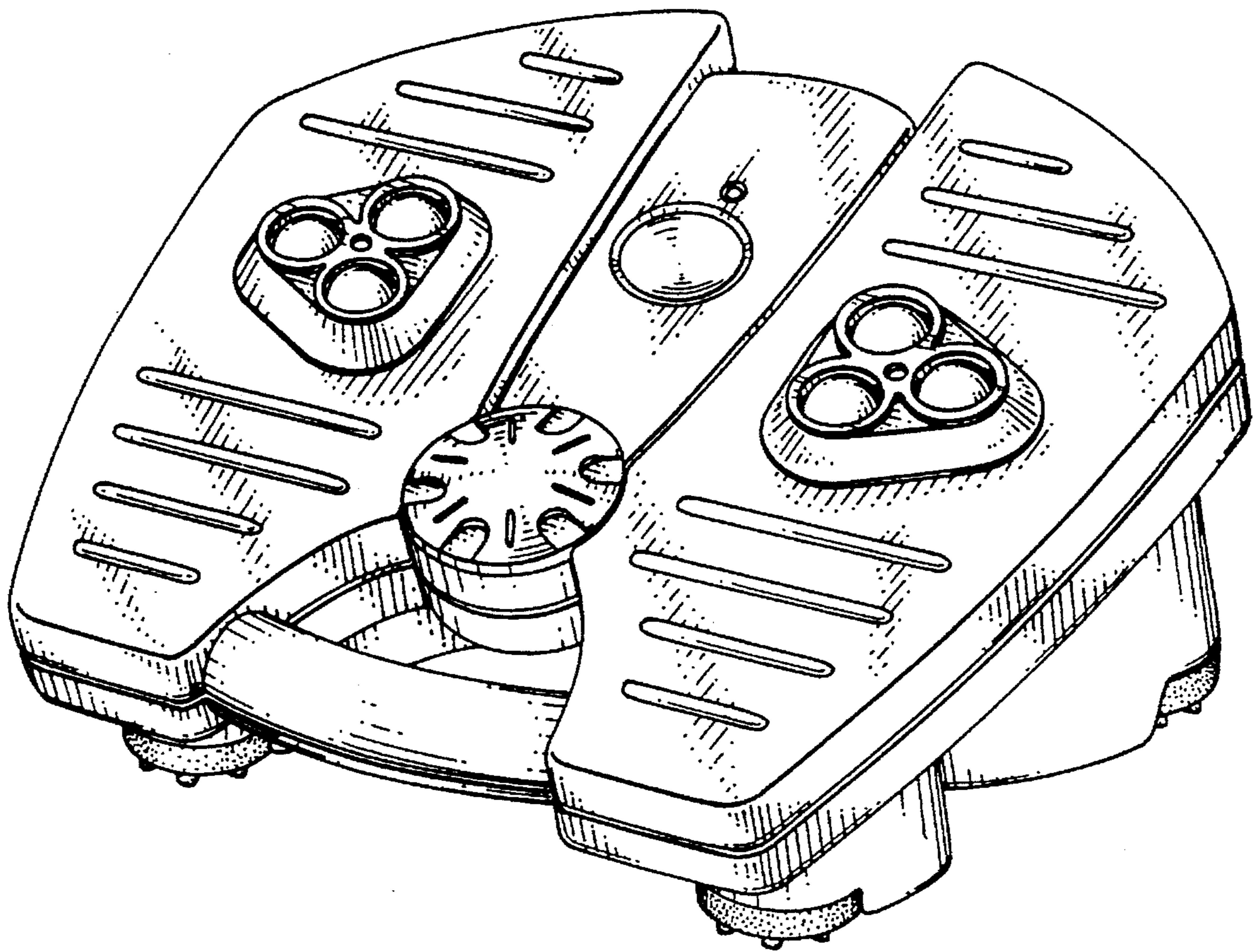
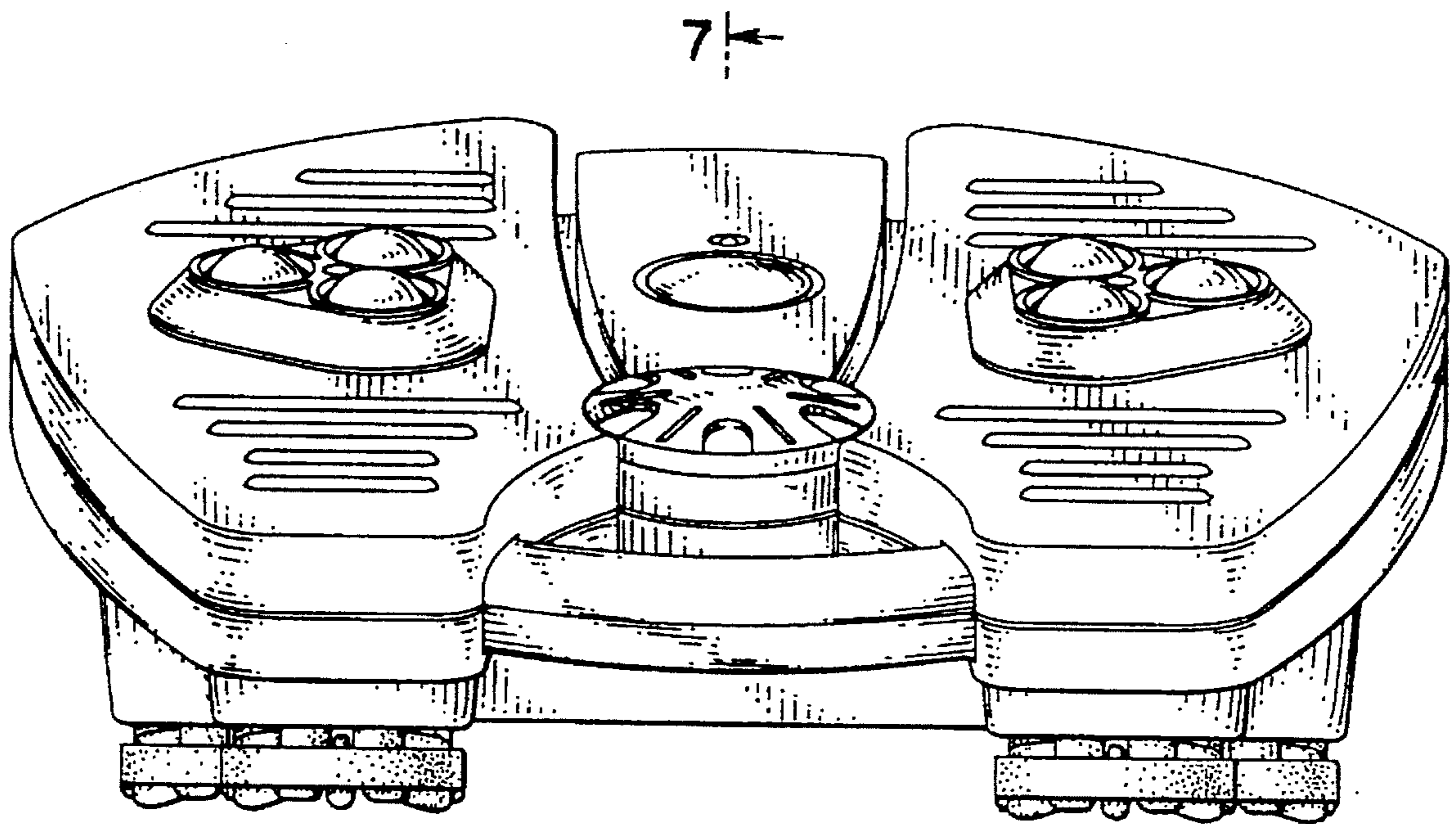
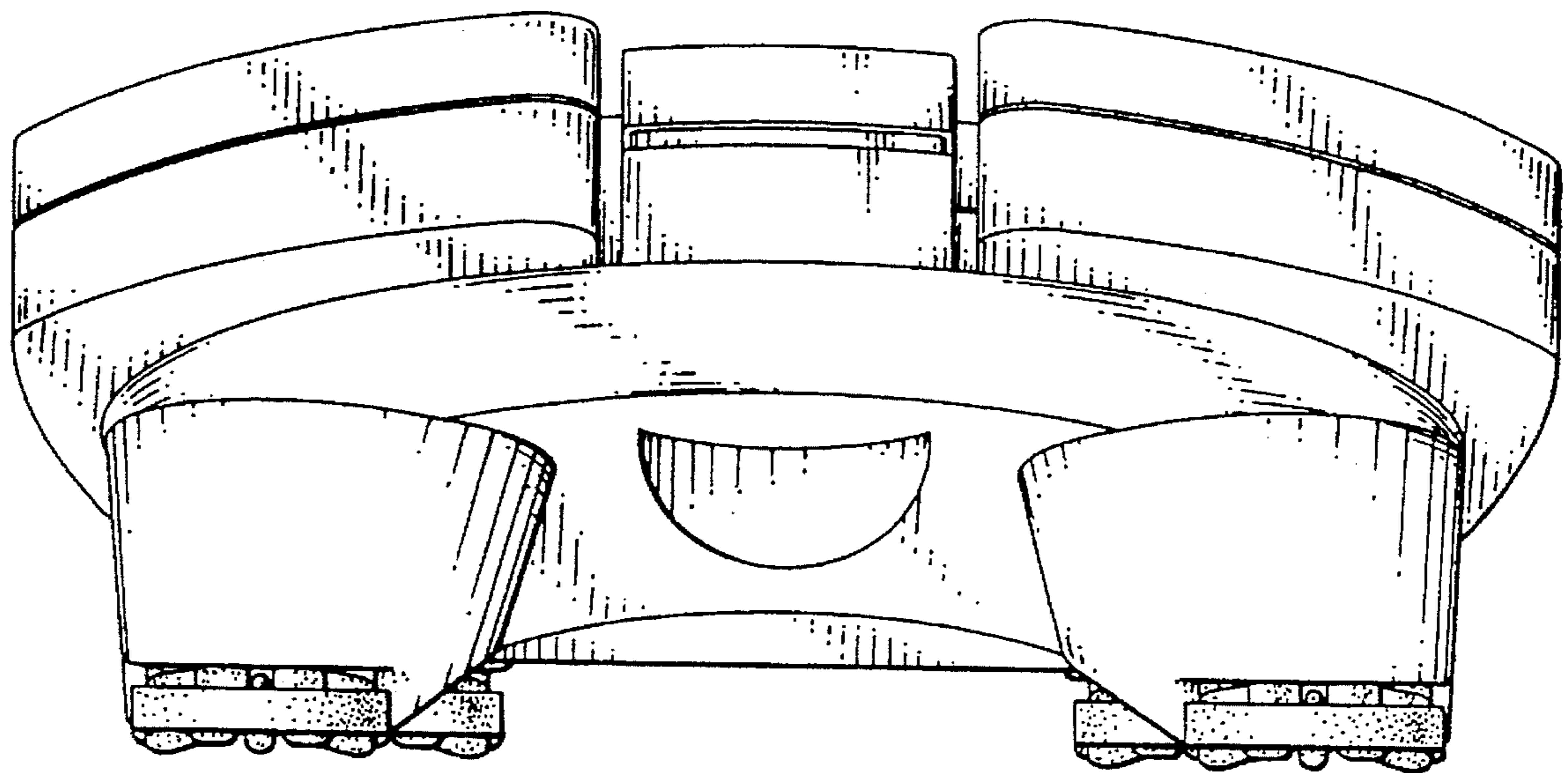

FIG. 1



7 ←
FIG. 2



7 ←
FIG. 3

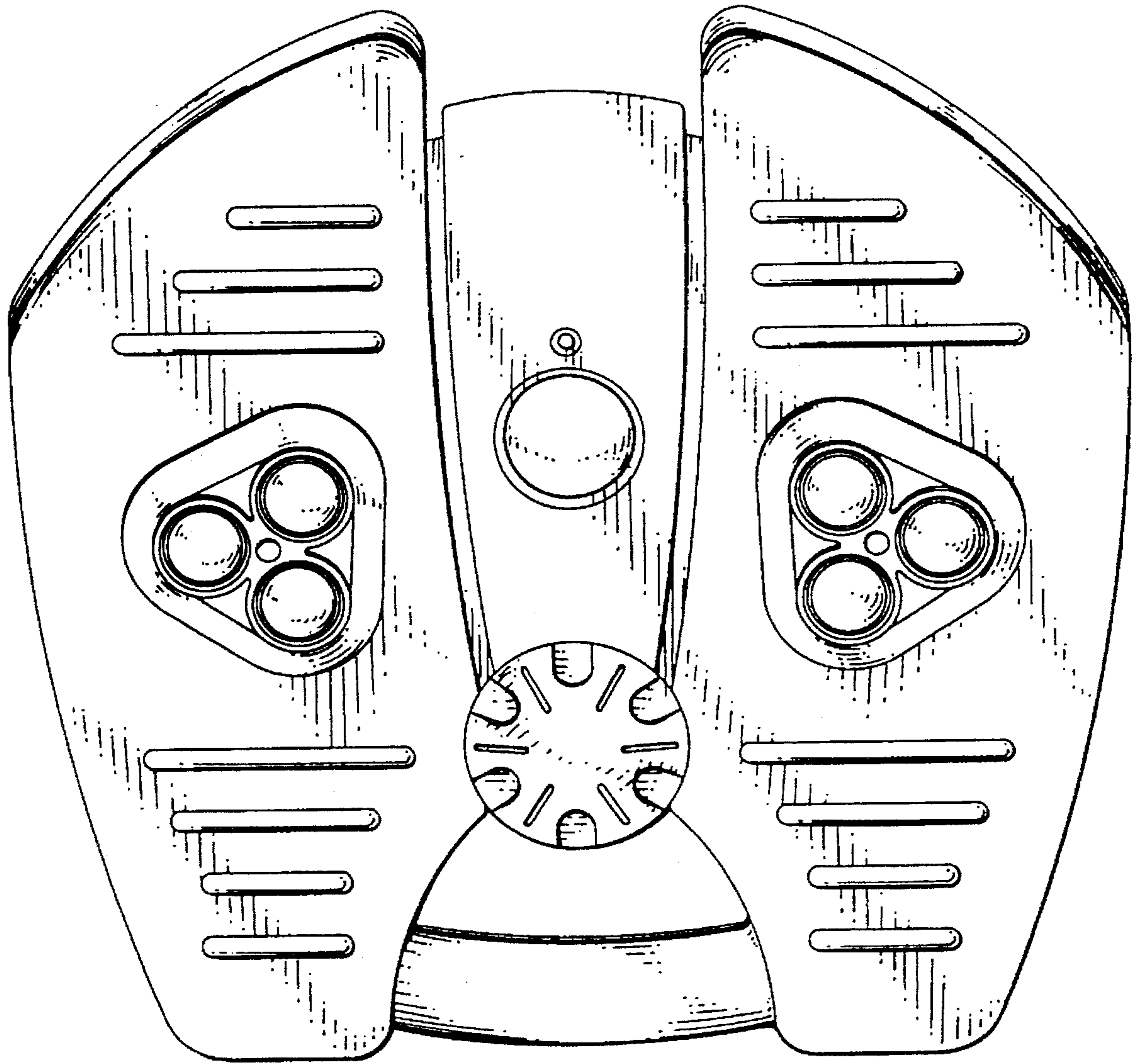

FIG. 4

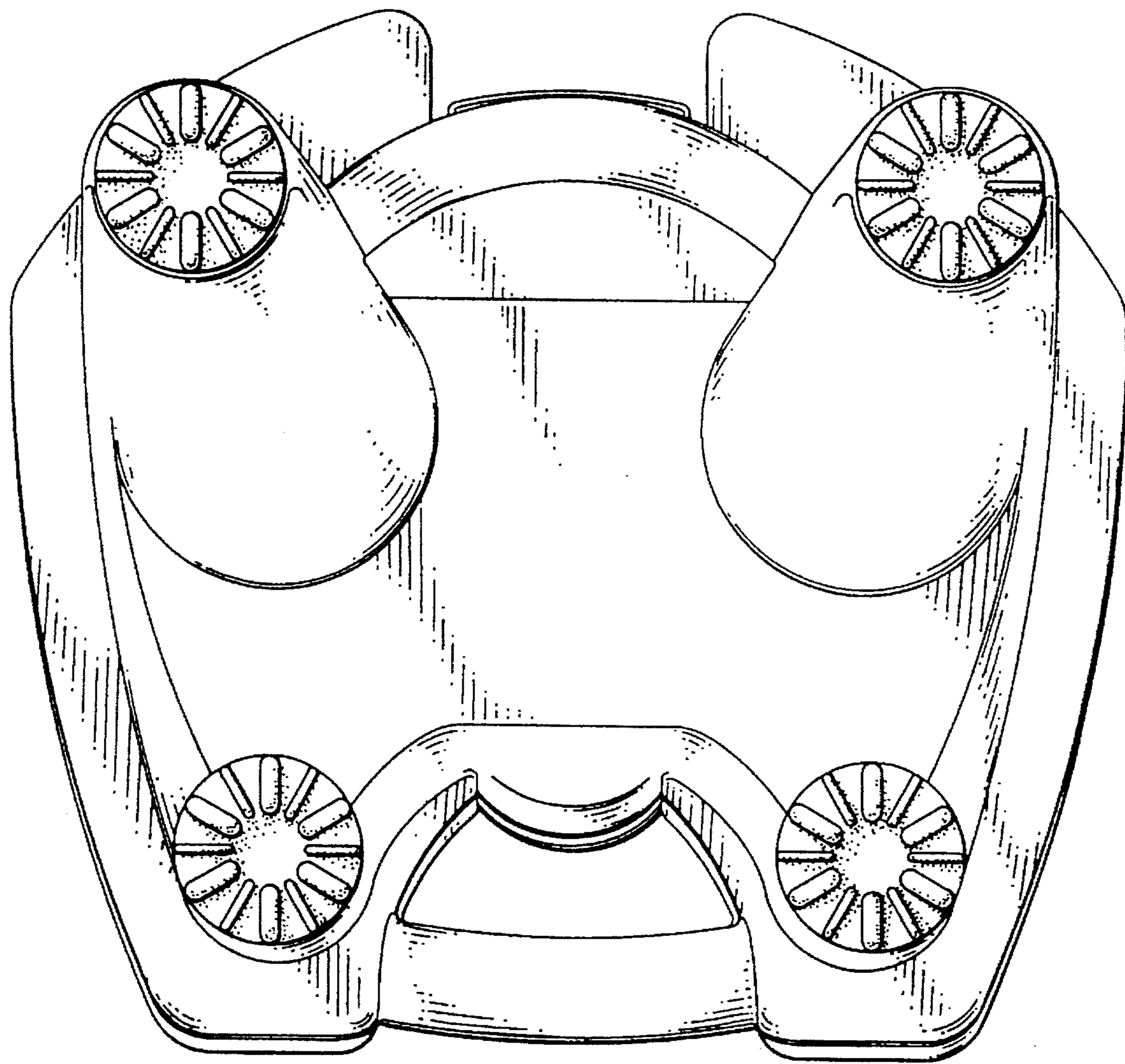

FIG. 5

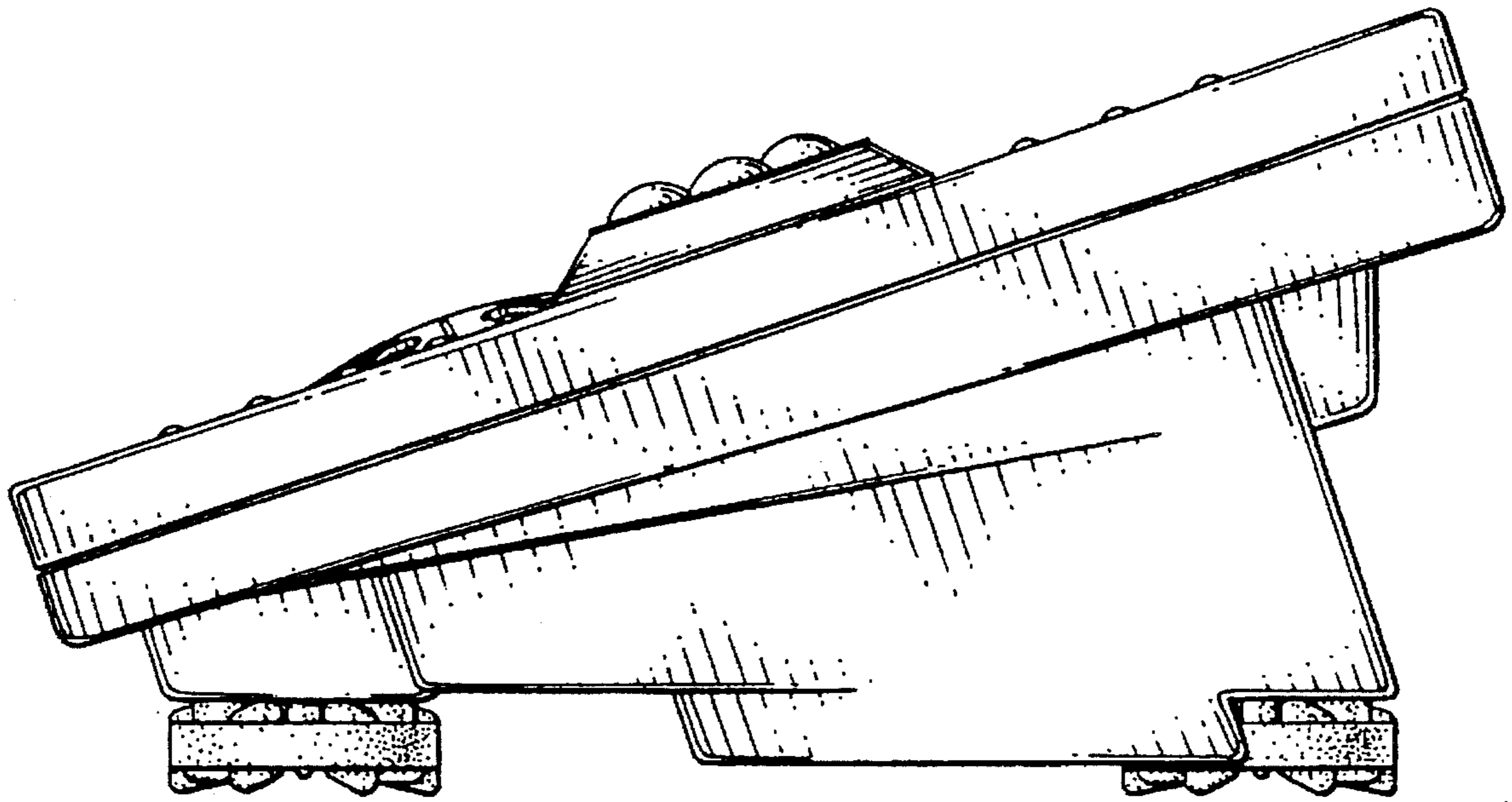

FIG. 6

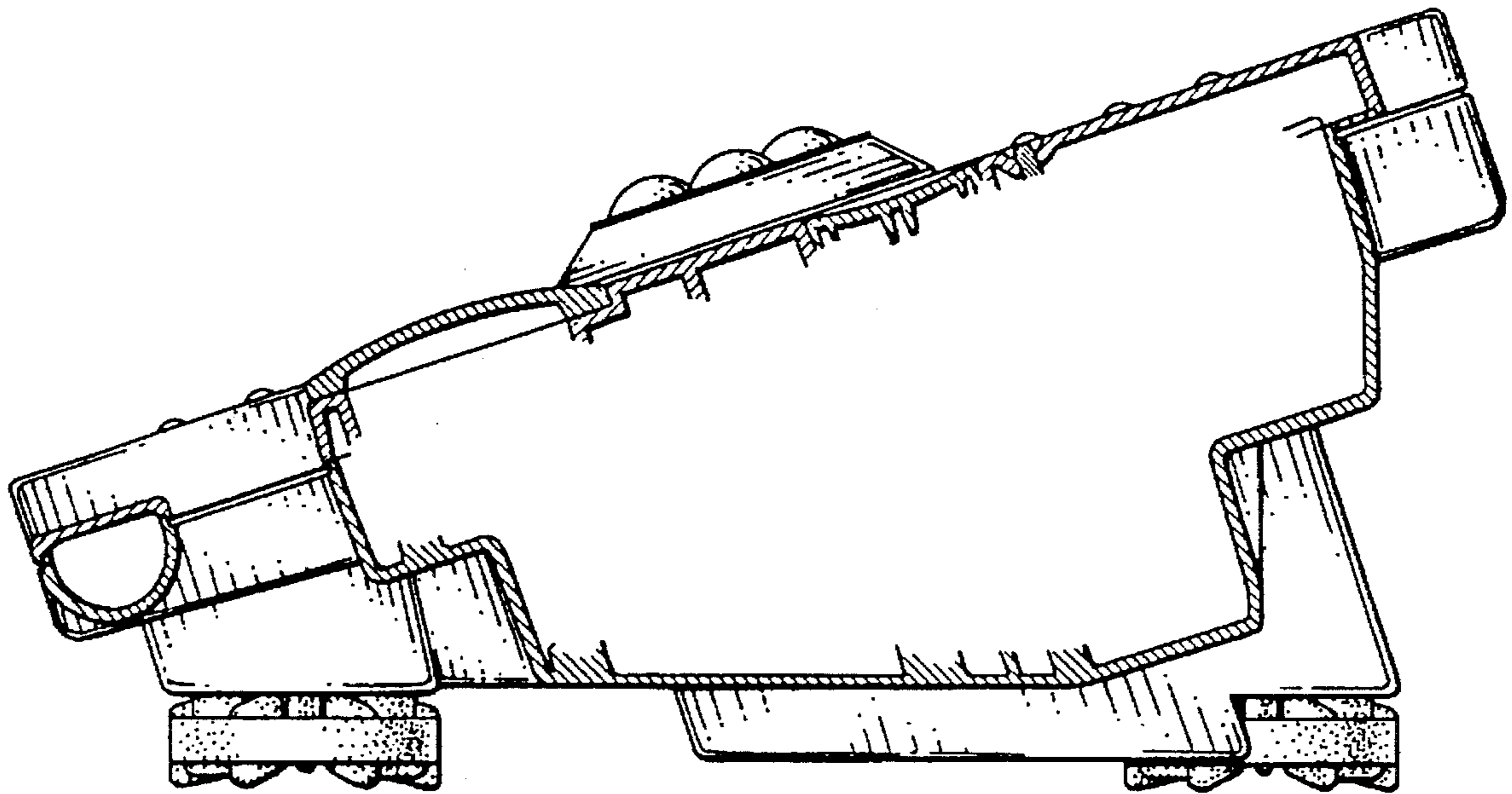

FIG. 7