



US00D363378S

United States Patent [19]
Fredricks

[11] **Patent Number: Des. 363,378**

[45] **Date of Patent: **Oct. 24, 1995**

[54] **FOOT SCRUBBER BRUSH**

4,047,259 9/1977 Lotis .
4,417,362 11/1983 Walker .

[76] Inventor: **Merle E. Fredricks**, 405 Main St., Box 271, Royal, Iowa 51357

Primary Examiner—A. Hugo Word
Assistant Examiner—Lavone D. Tabor
Attorney, Agent, or Firm—Terry M. Gernstein

[**] Term: **14 Years**

[57] **CLAIM**

[21] Appl. No.: **25,619**

The ornamental design for a foot scrubber brush, as shown and described.

[22] Filed: **Jul. 7, 1994**

[52] U.S. Cl. **D4/130**

[58] Field of Search D4/119-120, 130;
D28/63; D32/47; 15/110, 112, 159.1, 160,
161; 4/605-606

DESCRIPTION

[56] **References Cited**

U.S. PATENT DOCUMENTS

D. 189,287	11/1960	Dobbins	D32/47
D. 280,868	10/1985	Russell	D4/119 X
D. 297,376	8/1988	Bastedo	D28/63
1,327,943	1/1920	Cohen	15/112
3,631,560	1/1972	Atkins	

FIG. 1 is a front, top and side perspective view of the foot scrubber brush showing my new design;
FIG. 2 is a front elevational view thereof, the rear being a mirror image of the front shown in FIG. 2;
FIG. 3 is a side elevational view thereof, the side opposite being a mirror image of the side shown in FIG. 3;
FIG. 4 is a top plan view thereof; and,
FIG. 5 is a bottom plan view thereof.

1 Claim, 3 Drawing Sheets

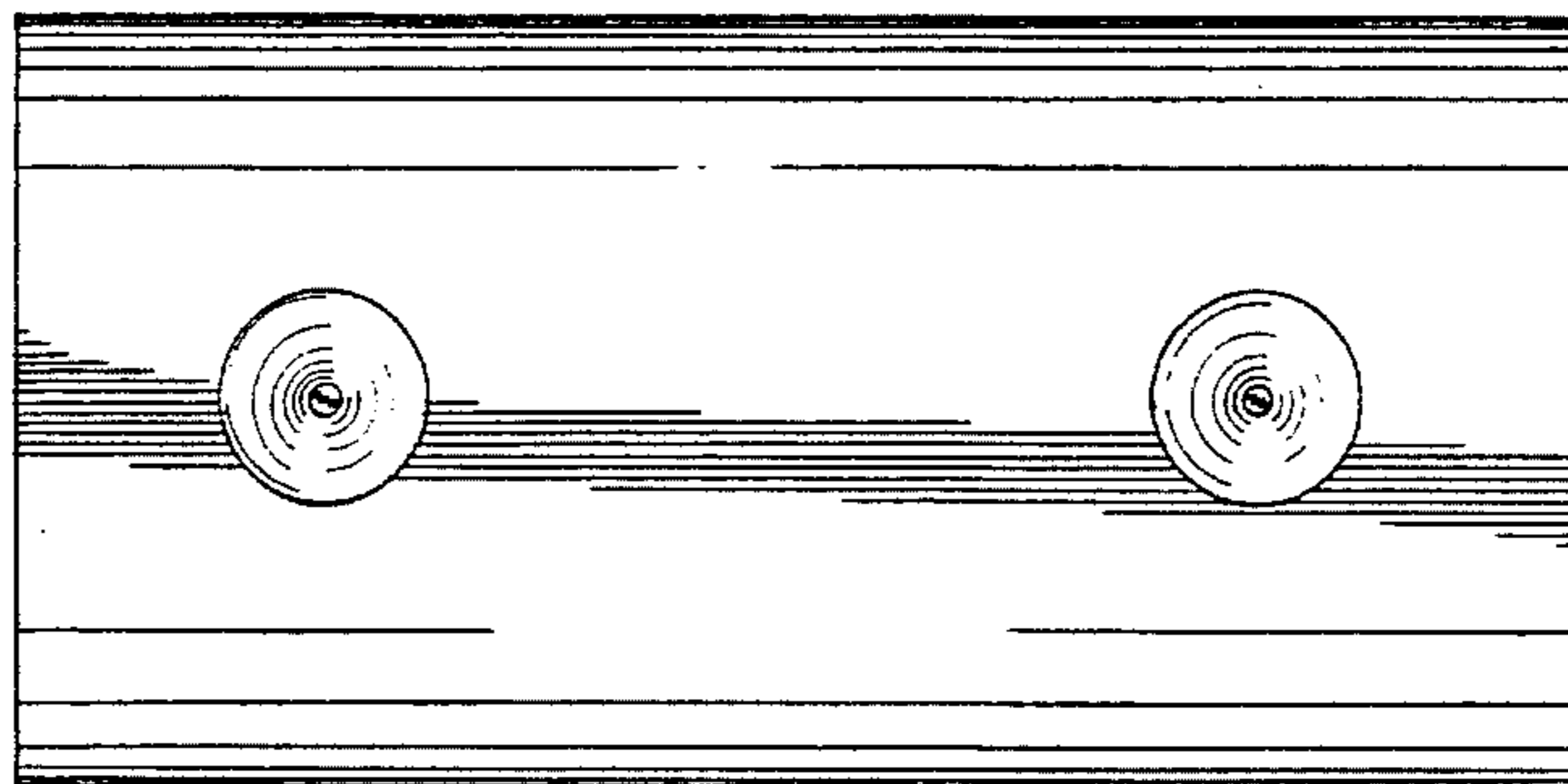
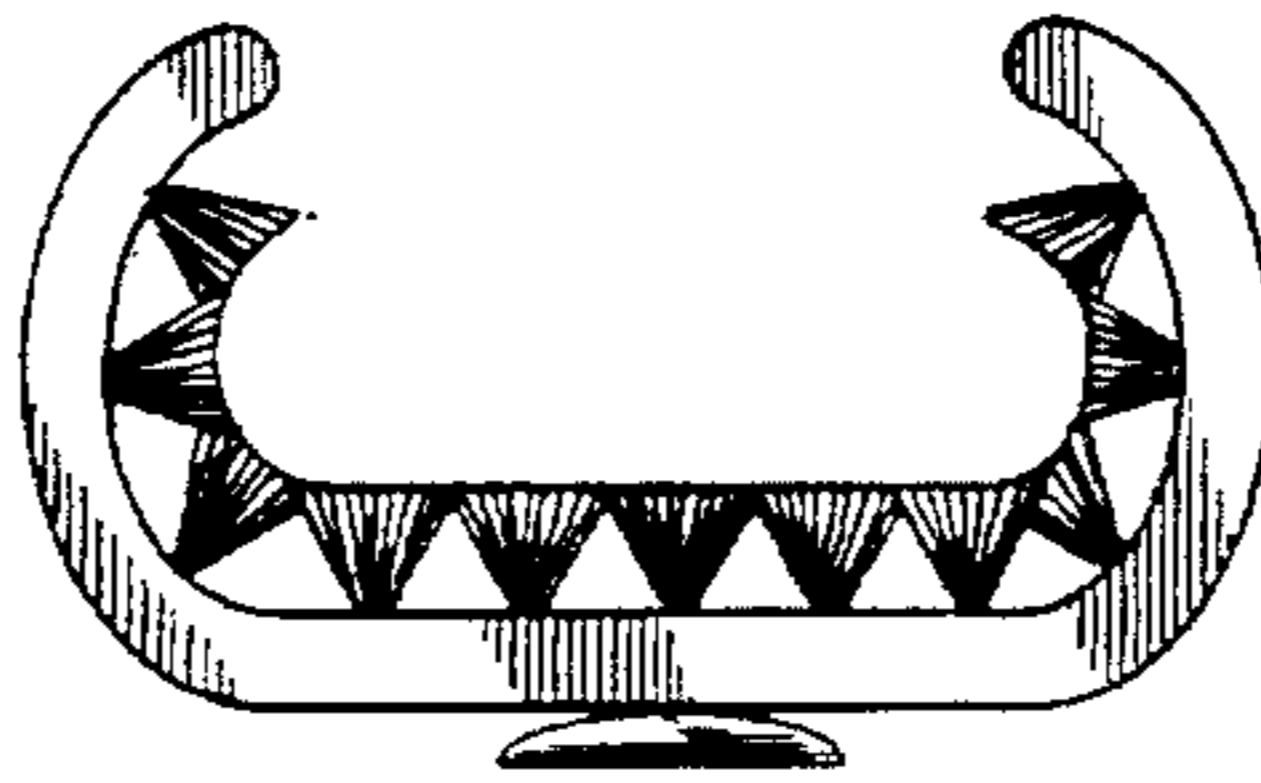
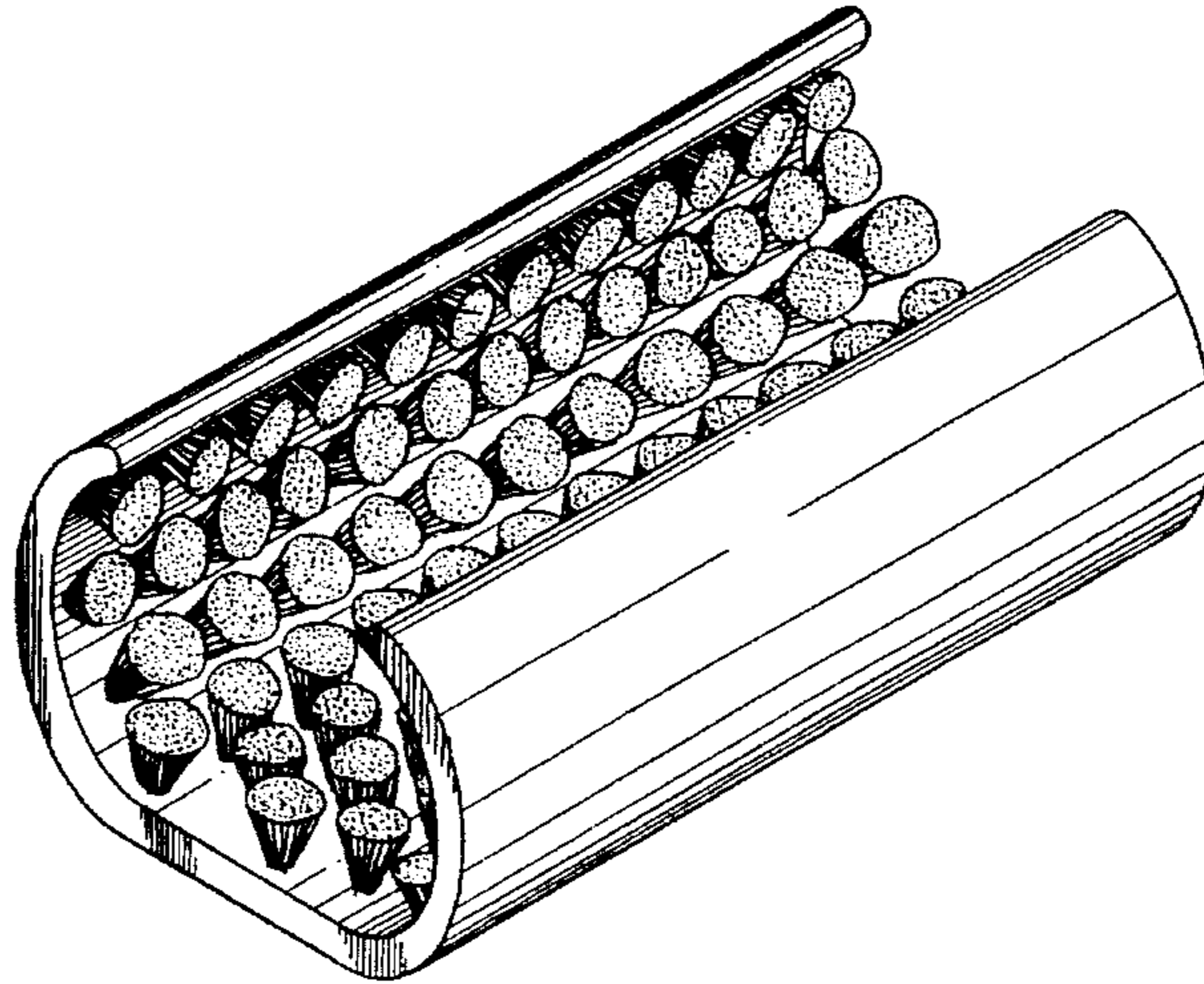

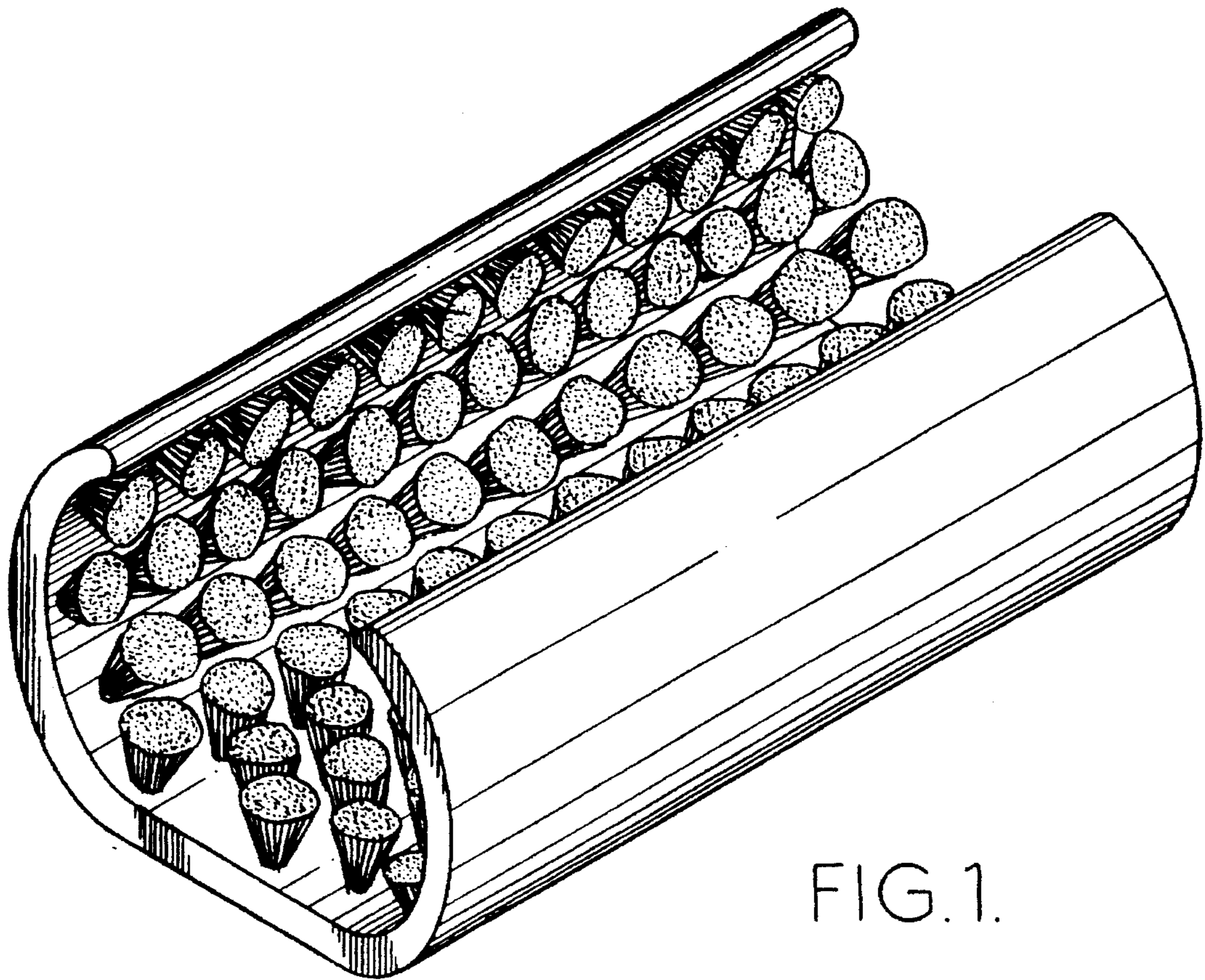

FIG. 1.

FIG. 3.

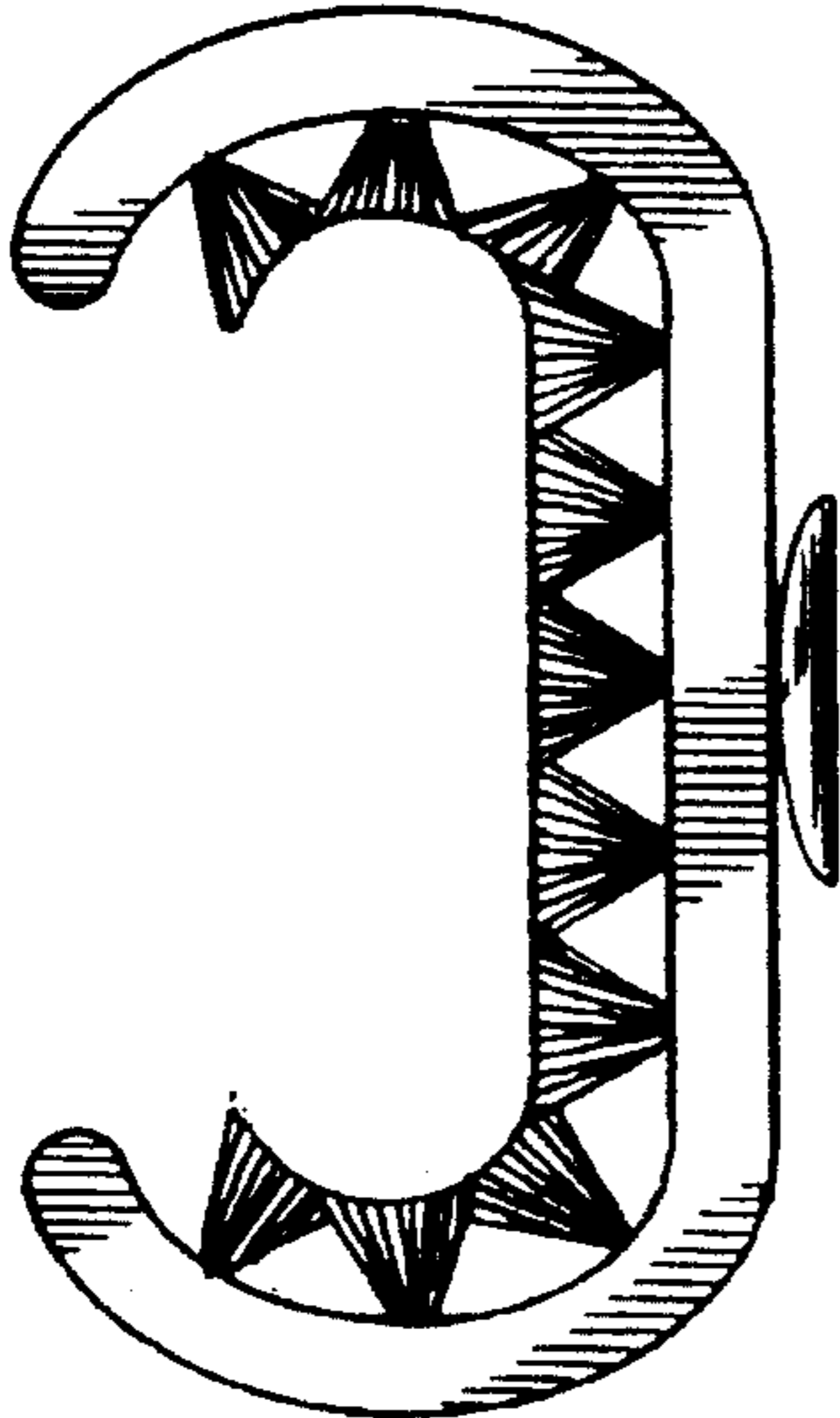

FIG. 2.

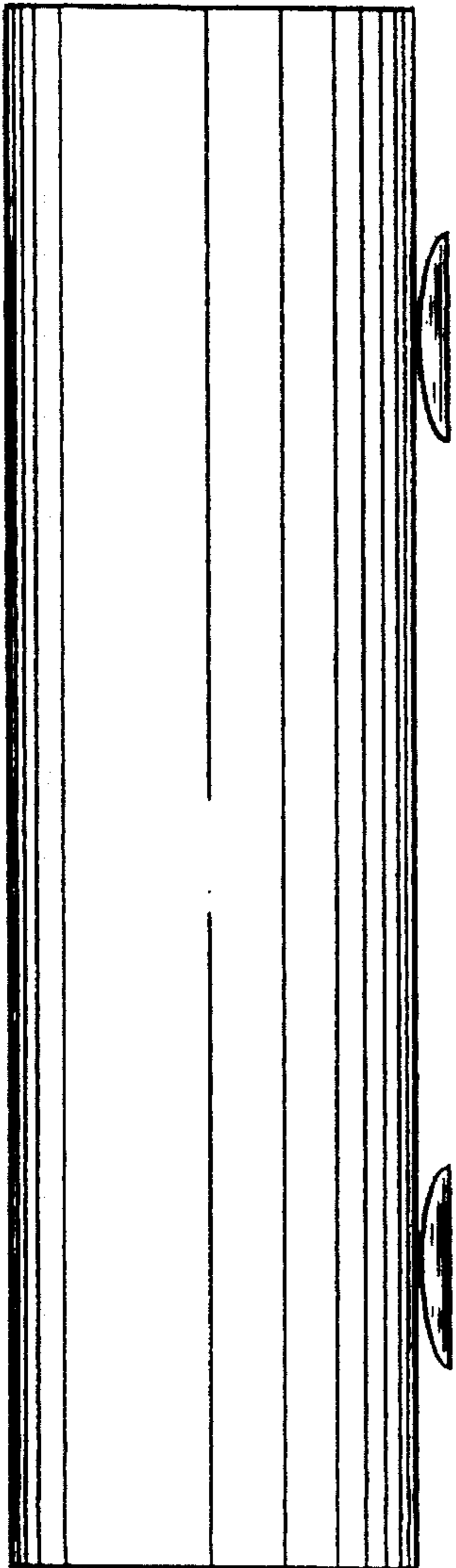
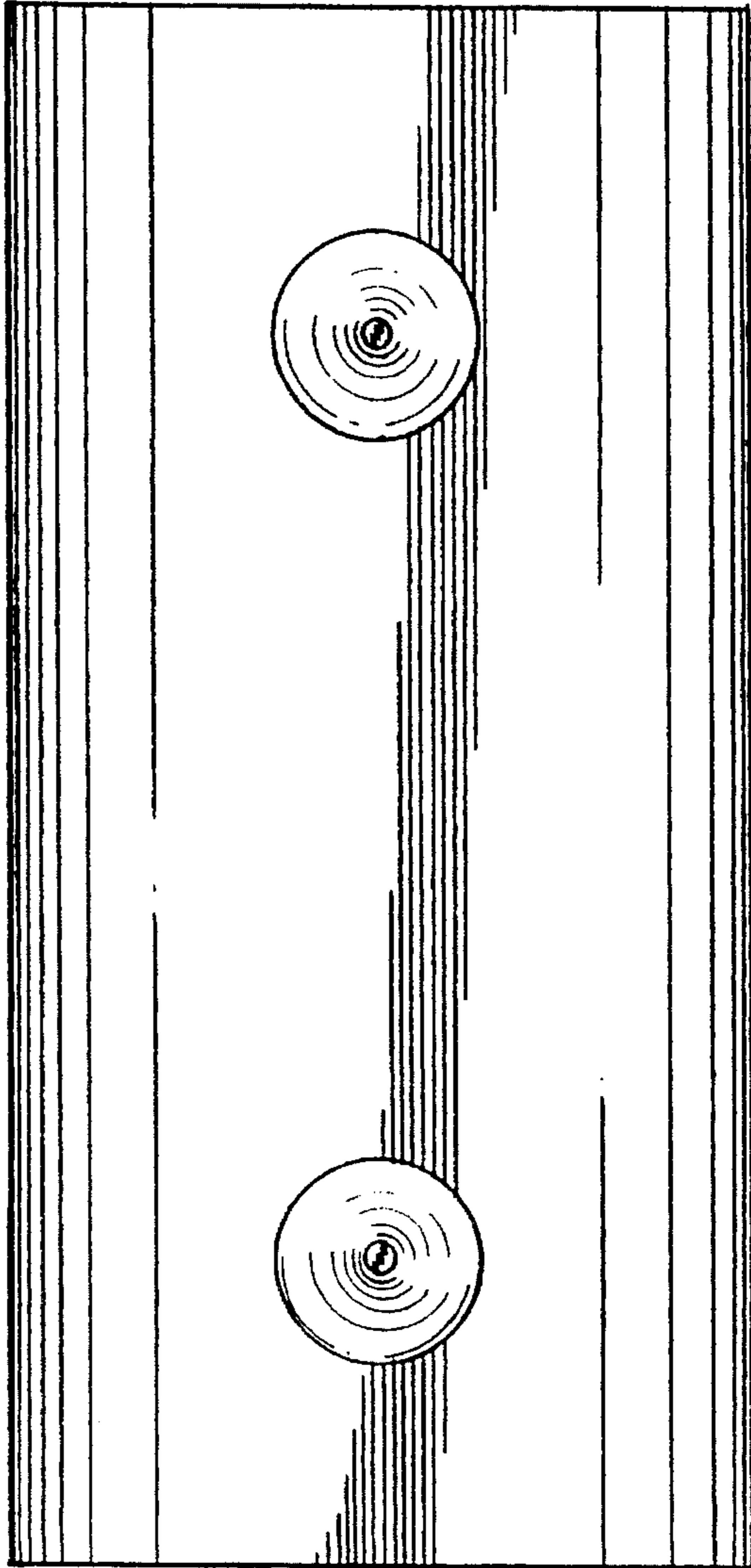

FIG. 5.



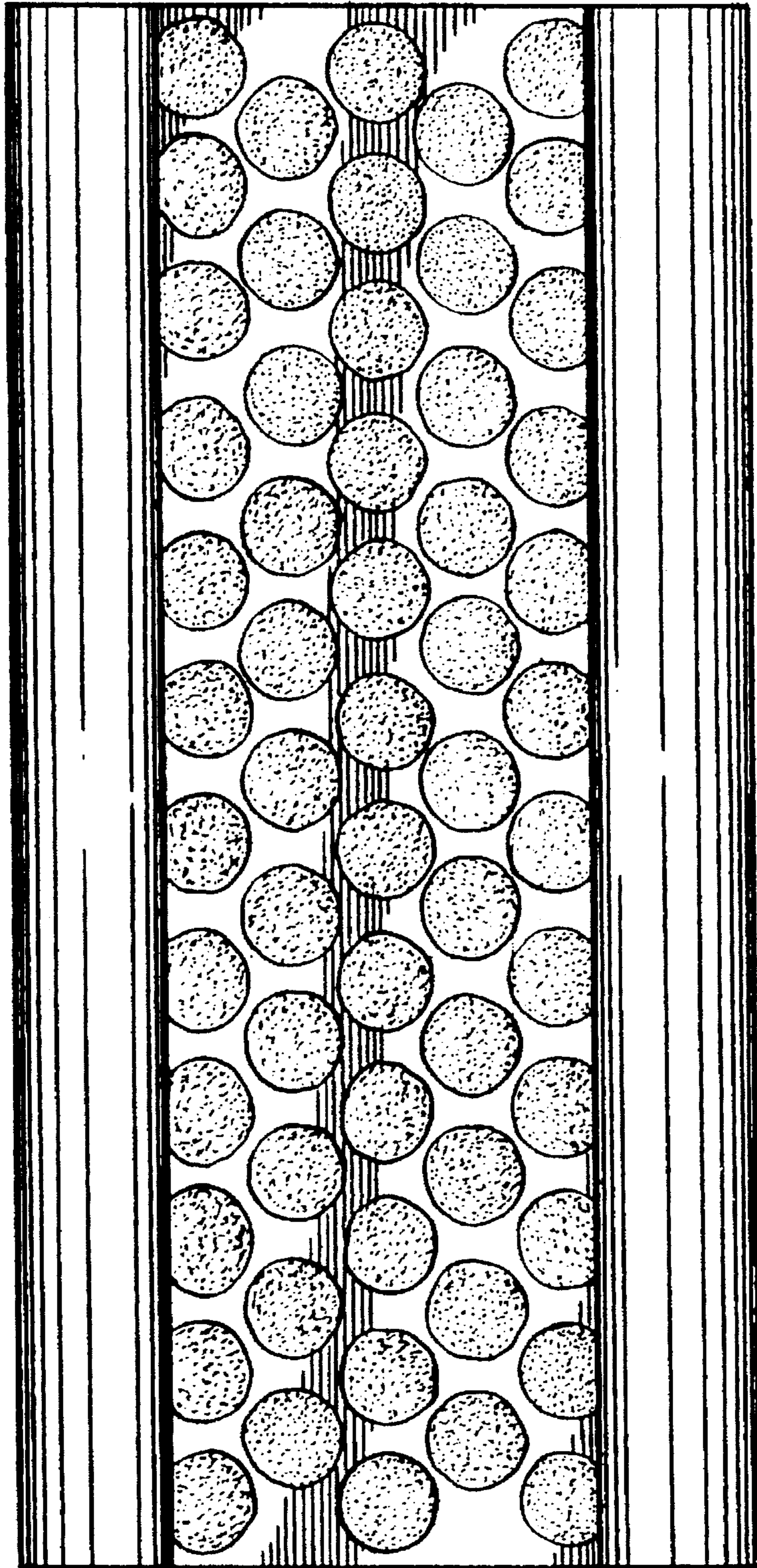

FIG. 4.