



US00D363370S

**United States Patent** [19]  
**Hamdan**

[11] **Patent Number: Des. 363,370**

[45] **Date of Patent: \*\*Oct. 17, 1995**

[54] **LAUNDRY BAG**

[76] **Inventor: Sharif Hamdan, P.O. Box 86, Kingston, N.J. 08528**

[\*\*] **Term: 14 Years**

[21] **Appl. No.: 26,123**

[22] **Filed: Jul. 20, 1994**

[52] **U.S. Cl. .... D32/36; D3/216**

[58] **Field of Search ..... D32/36, 37; D3/215, D3/216, 327; 224/153**

[56] **References Cited**

**U.S. PATENT DOCUMENTS**

D. 215,343	9/1969	Christie .....	D32/36
D. 247,340	2/1978	Benstock .....	D32/36
2,428,795	10/1947	Fraze .....	224/153

**FOREIGN PATENT DOCUMENTS**

154365	4/1932	Switzerland .....	224/153
--------	--------	-------------------	---------

*Primary Examiner*—A. Hugo Word  
*Assistant Examiner*—Robin V. Taylor  
*Attorney, Agent, or Firm*—Mathews, Woodbridge & Collins

[57] **CLAIM**

The ornamental design for a laundry bag, as shown and described.

**DESCRIPTION**

FIG. 1 is a perspective view of a laundry bag showing my new design;  
FIG. 2 is a top plan view;  
FIG. 3 is a bottom plan view;  
FIG. 4 is a front plan view;  
FIG. 5 is a rear plan view;  
FIG. 6 is a side elevational view; and,  
FIG. 7 is a side elevational view showing the side opposite that is seen in FIG. 6.

**1 Claim, 3 Drawing Sheets**

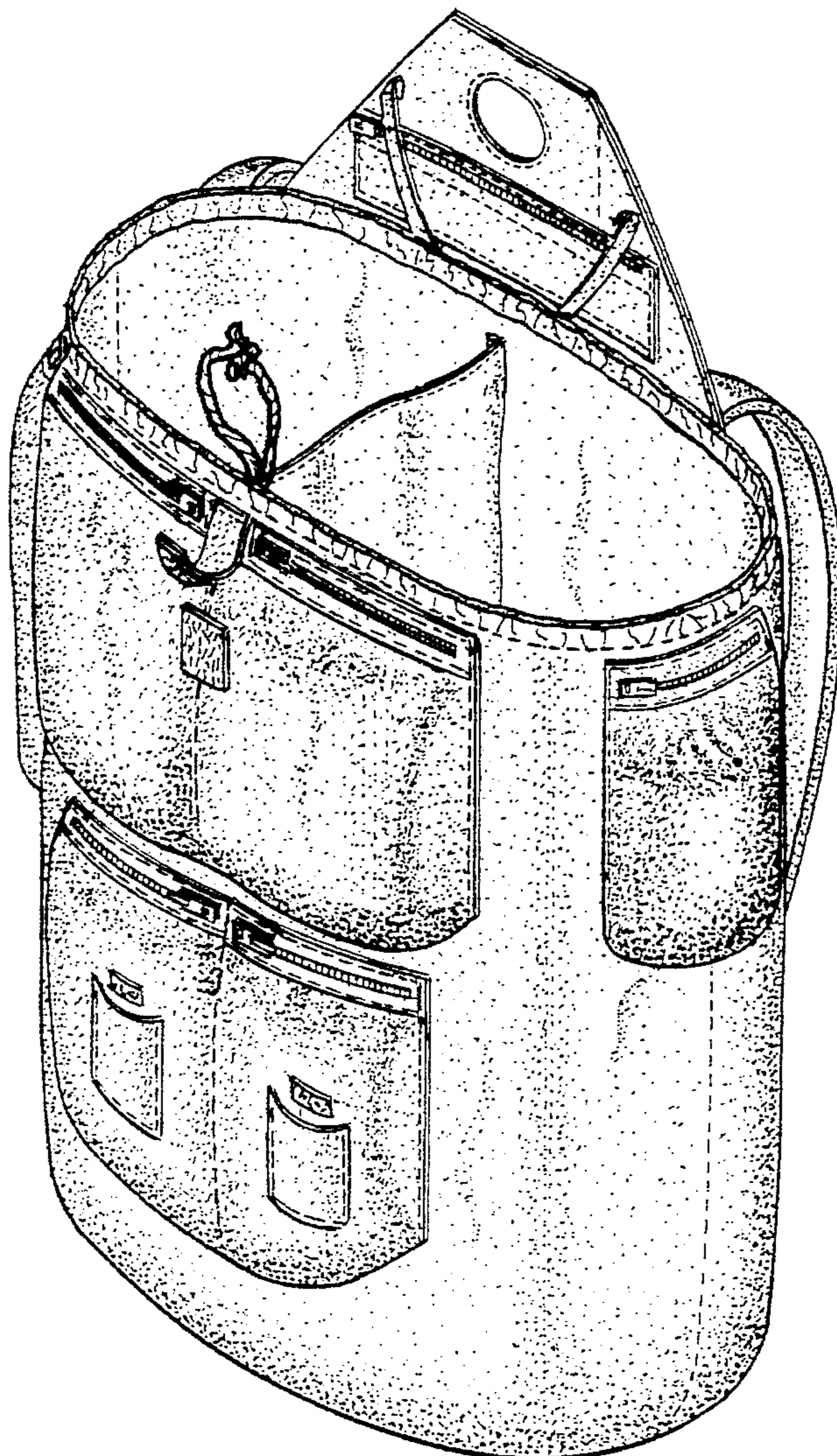

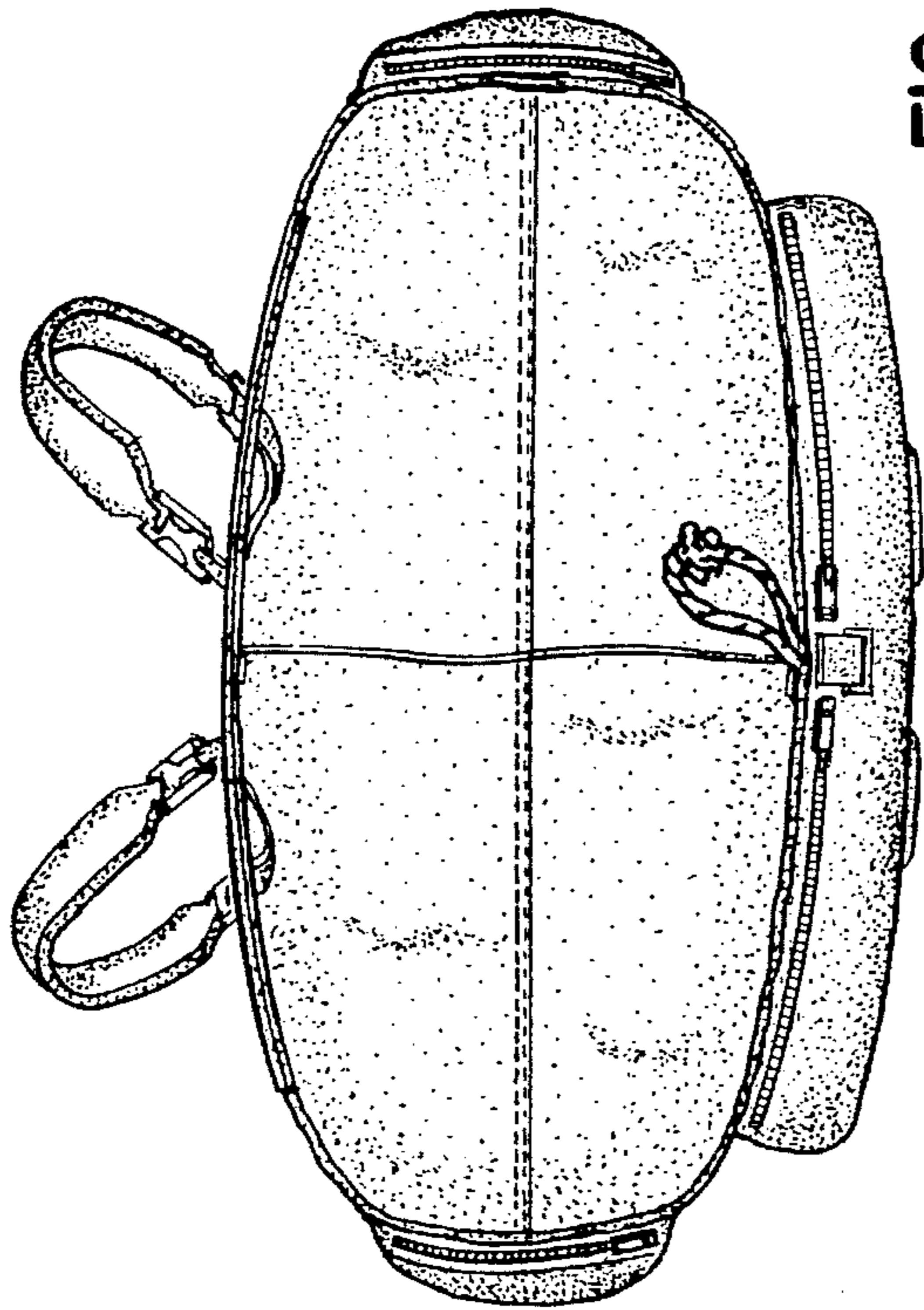

FIG. 2

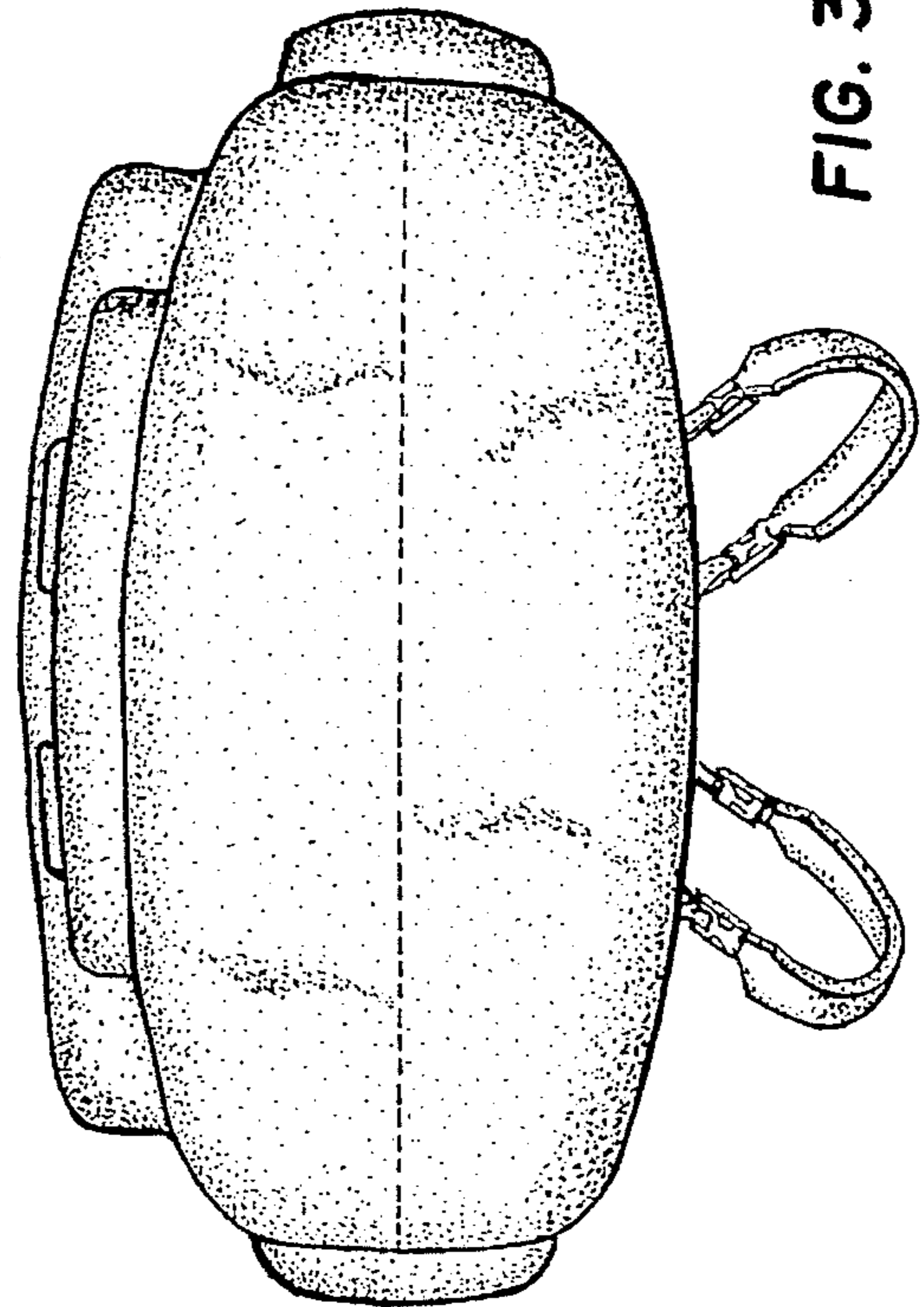

FIG. 3

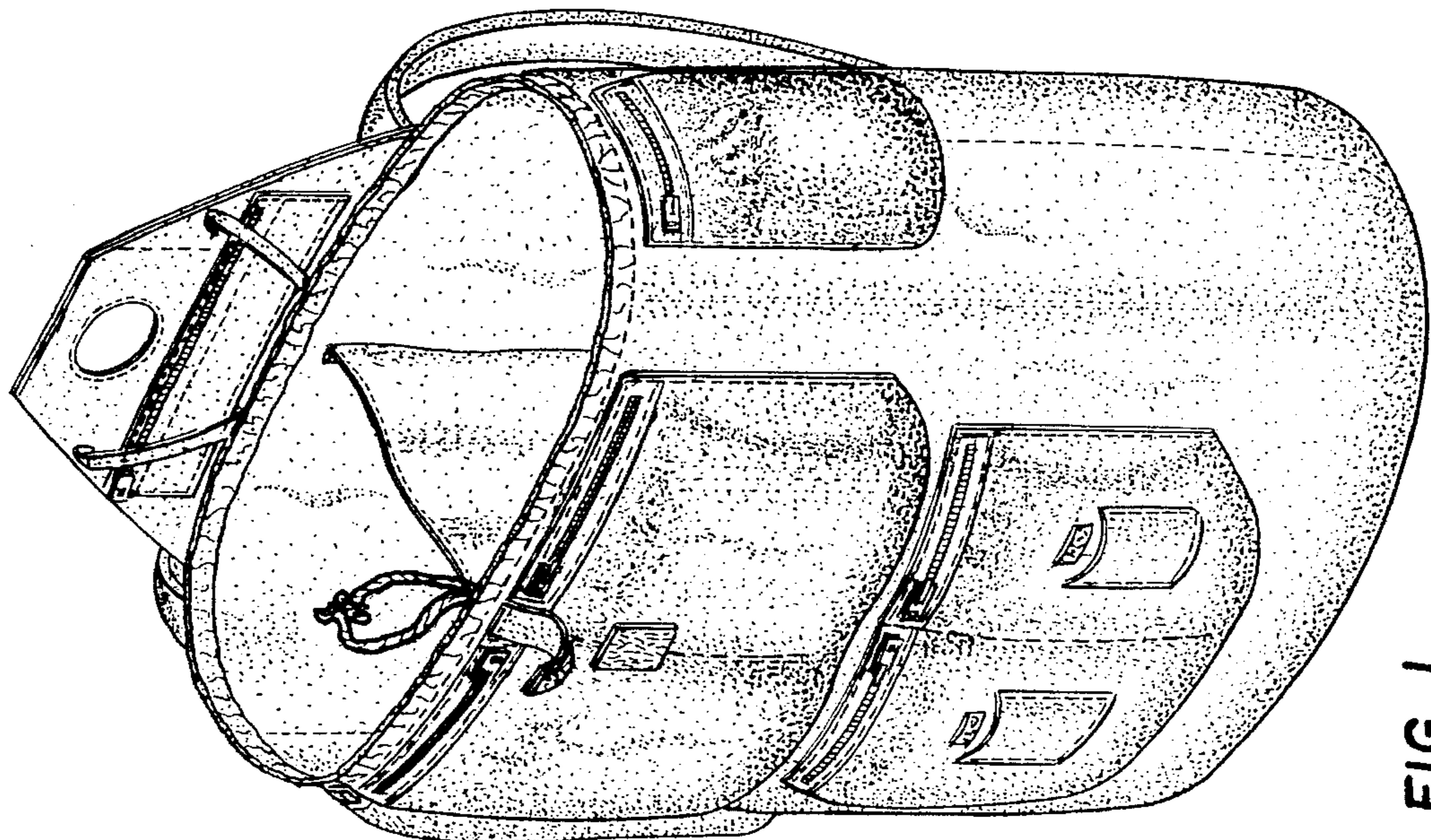

FIG. 1

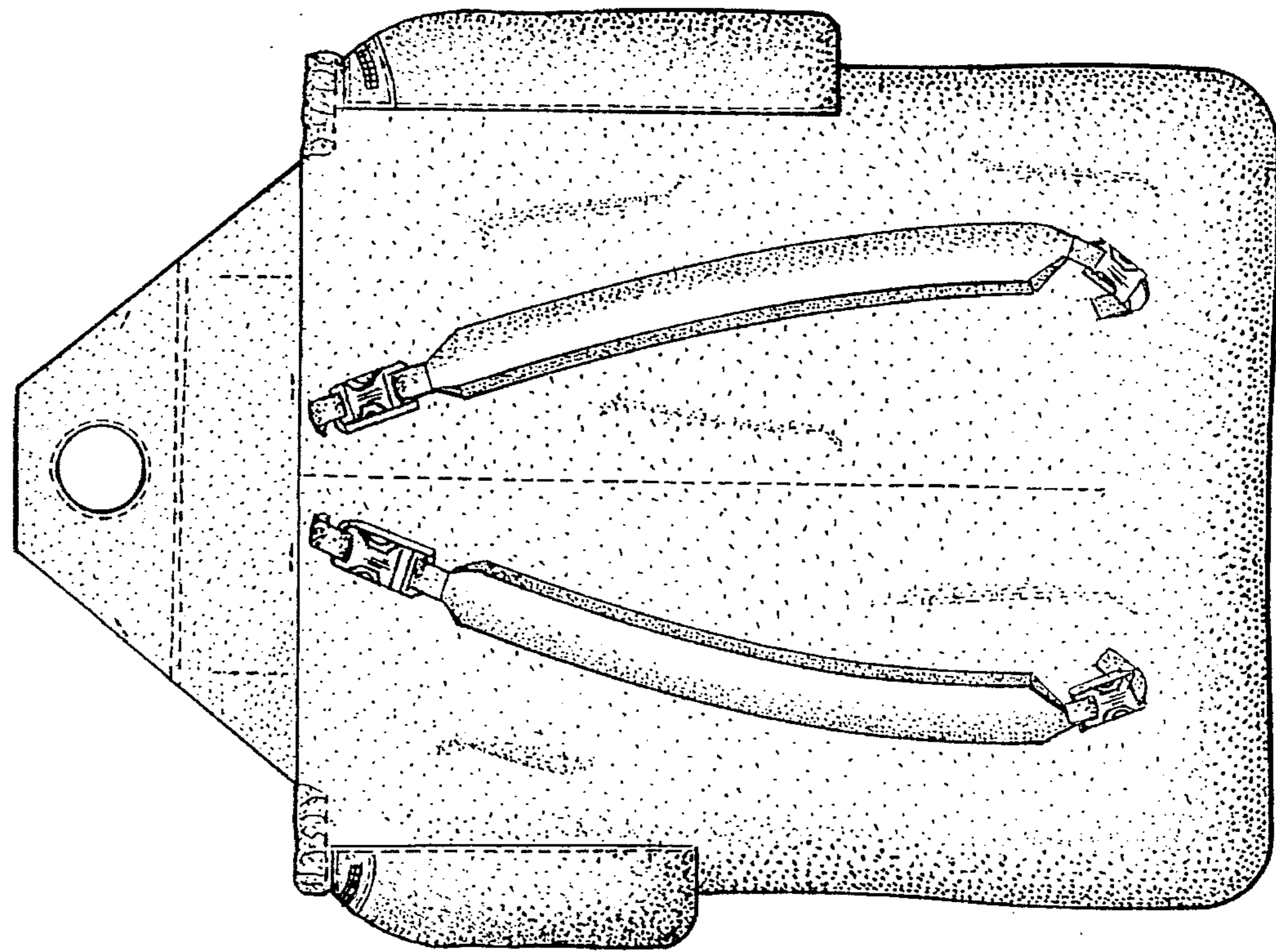

FIG. 5

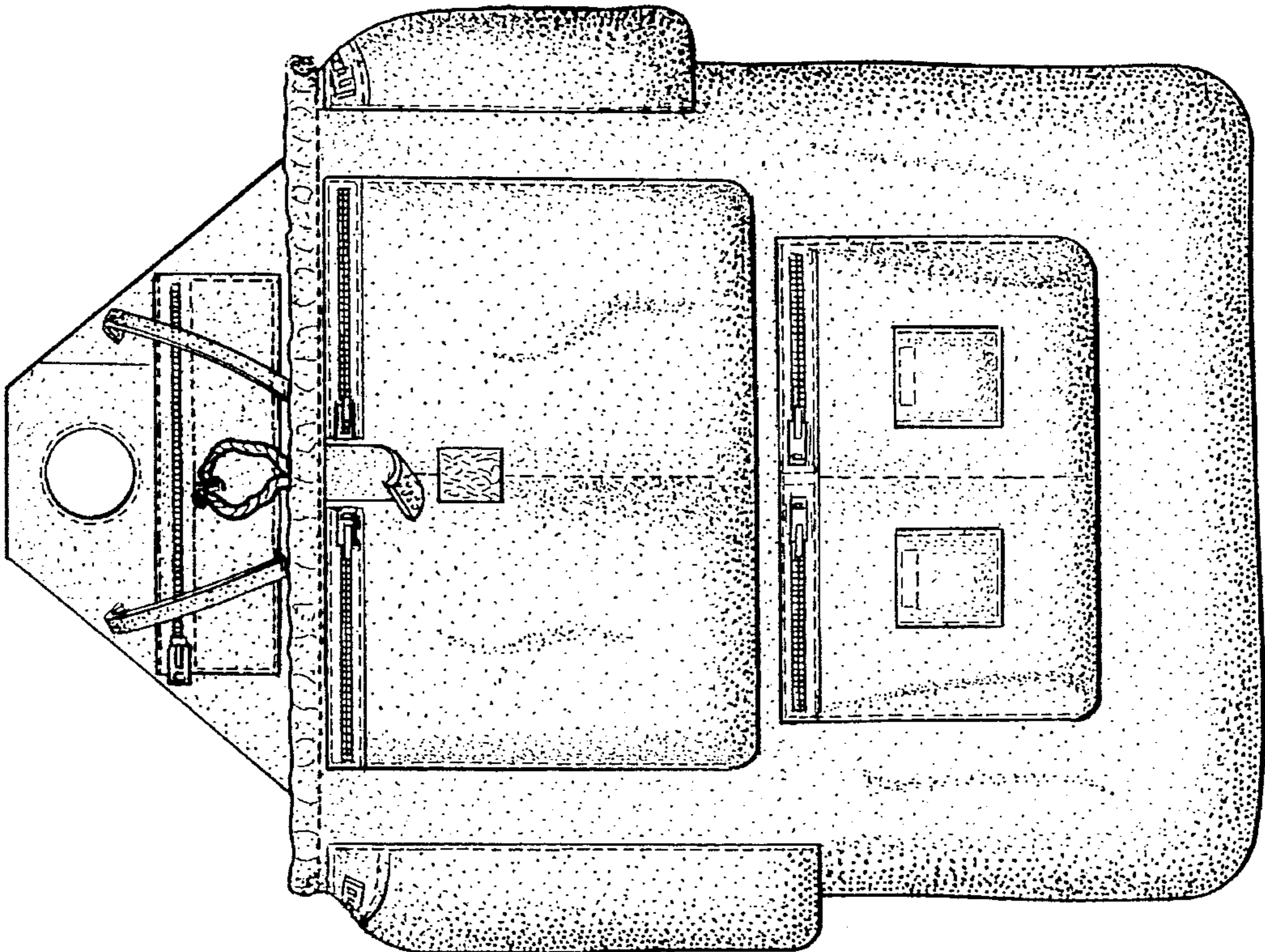

FIG. 4

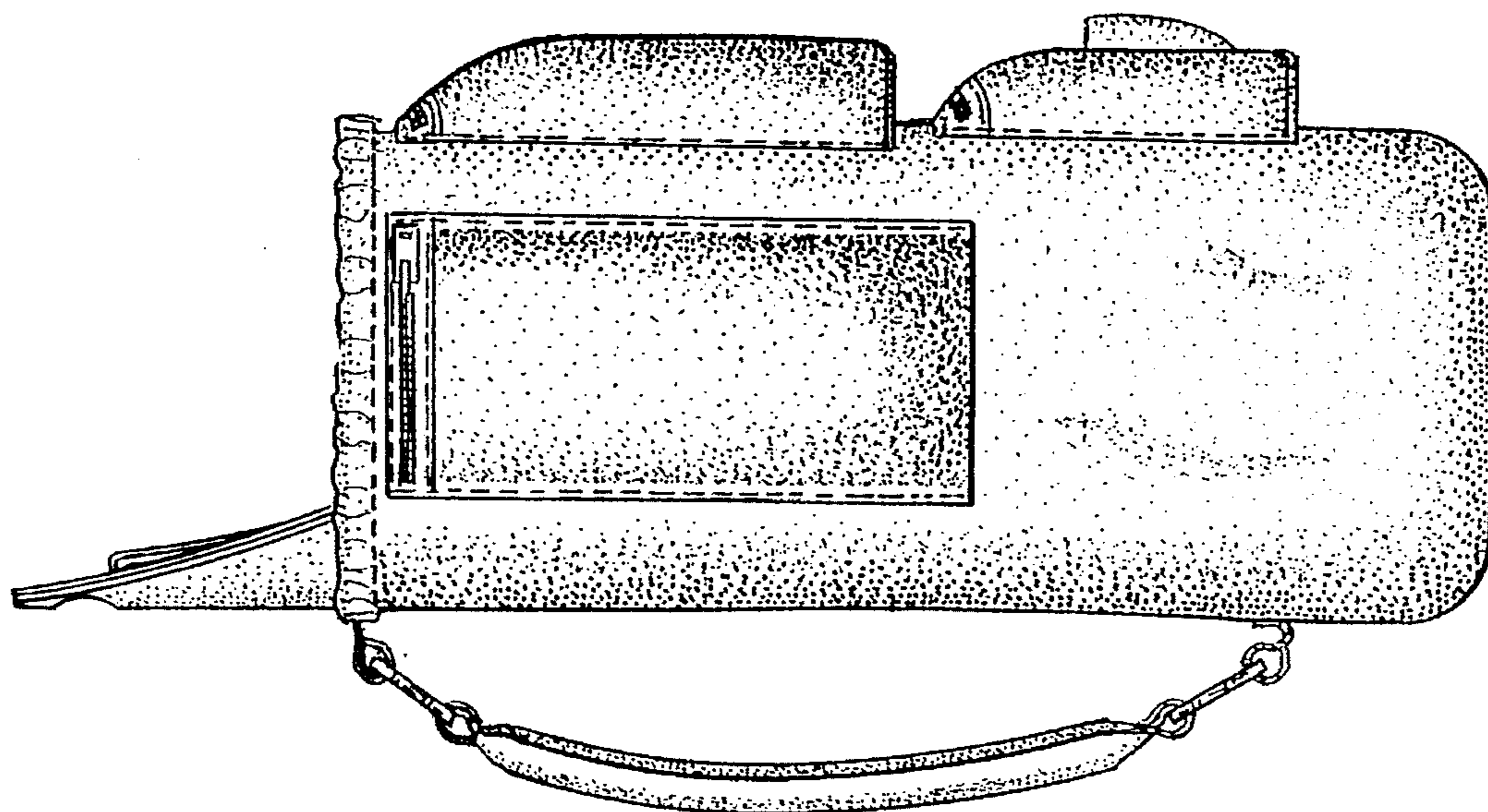

FIG. 7

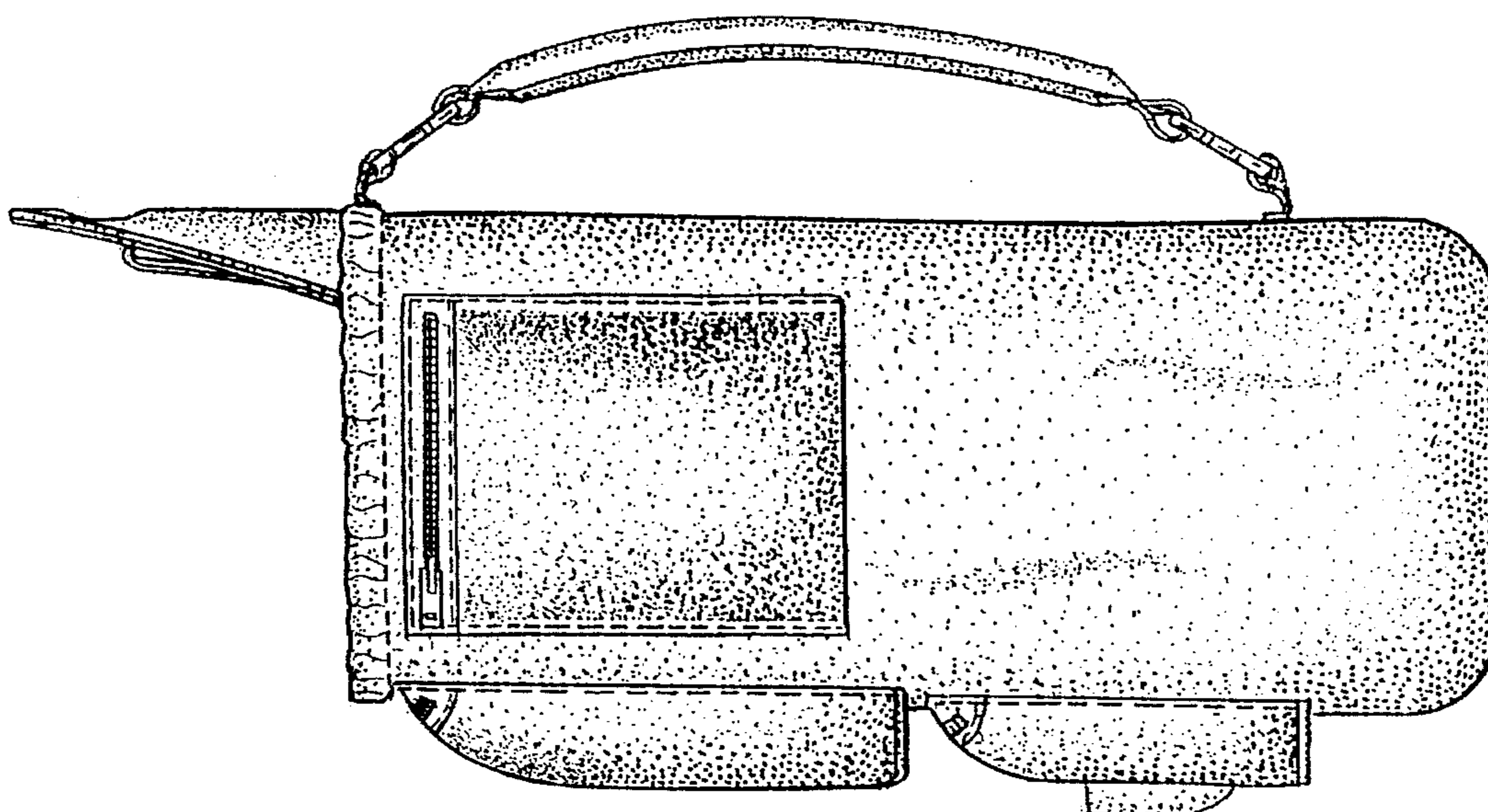

FIG. 6