



US00D363367S

United States Patent [19] Hampel

[11] Patent Number: **Des. 363,367**
[45] Date of Patent: ****Oct. 17, 1995**

[54] HOG SHELTER

[75] Inventor: **Lance T. Hampel**, Germantown, Wis.

[73] Assignee: **L. T. Hampel Corp.**, Germantown, Wis.

[**] Term: **14 Years**

[21] Appl. No.: **22,537**

[22] Filed: **May 6, 1994**

[52] U.S. Cl. **D30/108; D30/161**

[58] Field of Search 119/19, 15, 16,
119/28.5, 20; D30/108-109, 161

[56] References Cited

U.S. PATENT DOCUMENTS

D. 232,104	7/1974	Baigue	D30/108
D. 267,904	2/1983	Hampel et al.	D30/108
D. 267,905	2/1983	Keith	D30/108
D. 288,733	3/1987	Welker	D30/108
D. 320,479	10/1991	Cheval et al.	D30/108
D. 343,481	1/1994	Hampel	D30/108
2,732,826	1/1956	Dawson	119/20
3,129,693	4/1964	DeVore	119/16
3,172,392	3/1965	Schultz	119/20
4,161,924	7/1979	Welker	119/19
4,201,153	5/1980	Nace	119/15
4,495,892	1/1985	Jodar et al.	119/16

OTHER PUBLICATIONS

Better Homes & Gardens; Sep. 1973; p. 66; Canine Castle advertisement.

Igloo Dog Homes advertisement in Joan Cook Catalog; Feb. 4, 1987; p. 48; Litter Box.

Hampel Corporation brochure for Pig-tel™ brooder box for piglets.

Agri-Plastics brochure for Box Hover piglet shelter.

Palco brochure for Poly Hot Box Piglets.

Primary Examiner—Cathy Anne MacCormac

Attorney, Agent, or Firm—Quarles & Brady

[57] CLAIM

The ornamental design for the hog shelter, as shown and described.

DESCRIPTION

FIG. 1 is a perspective view showing the new design;

FIG. 2 is a back elevational view thereof;

FIG. 3 is a front elevational view thereof;

FIG. 4 is an elevational view of one side, the other side is the same;

FIG. 5 is a top plan view thereof;

FIG. 6 is a bottom plan view thereof; and,

FIG. 7 is a perspective view taken from the rear.

1 Claim, 4 Drawing Sheets

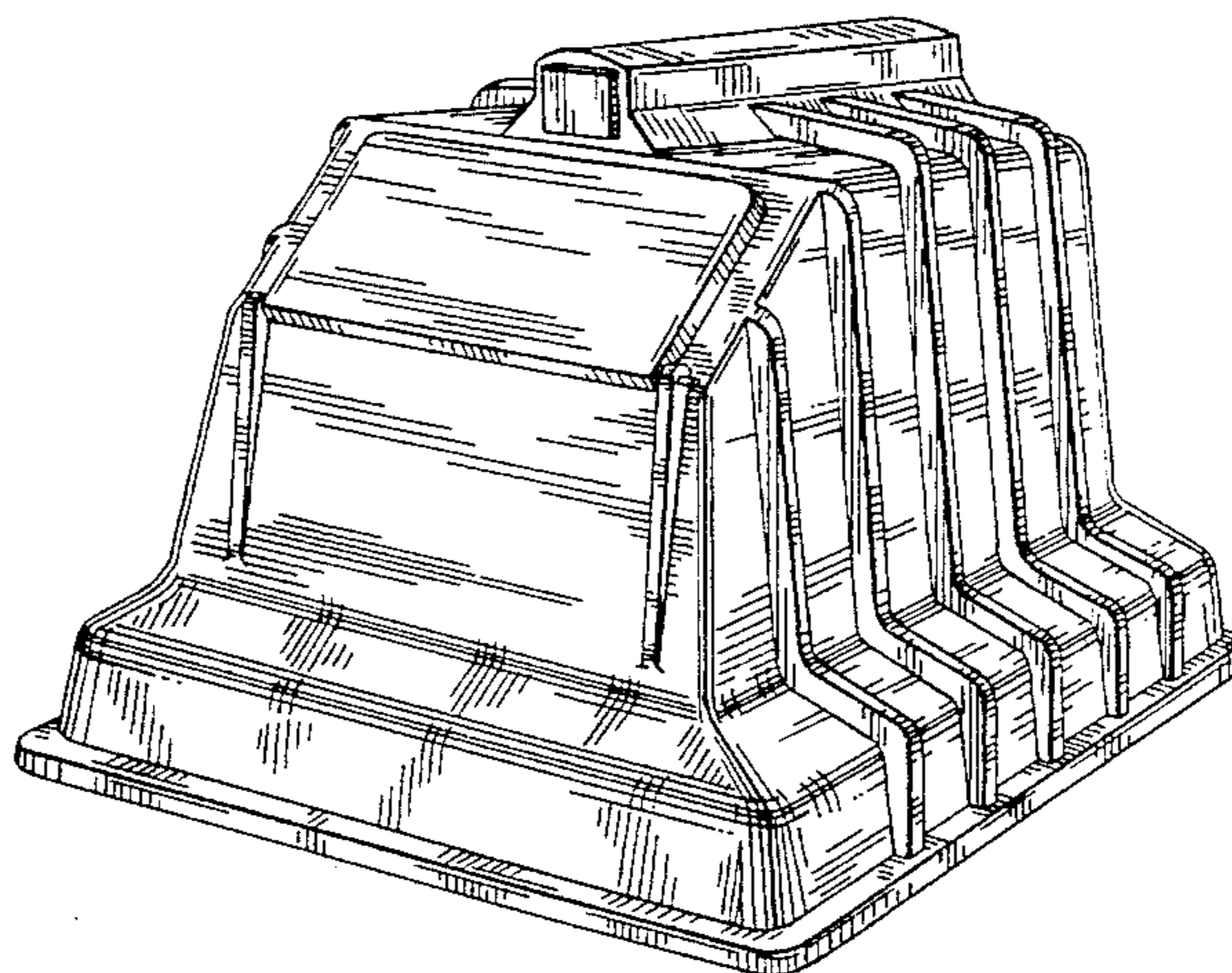
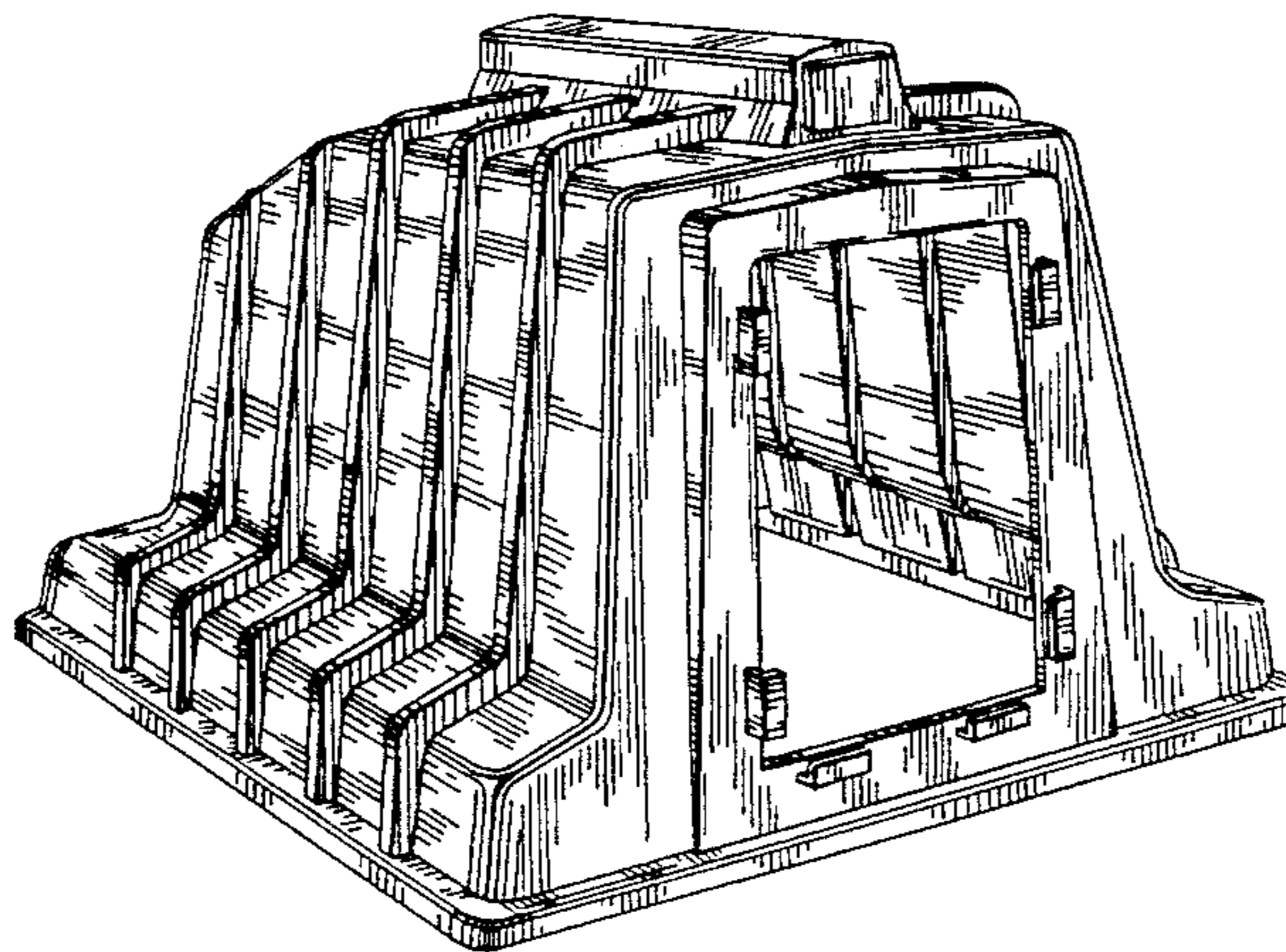

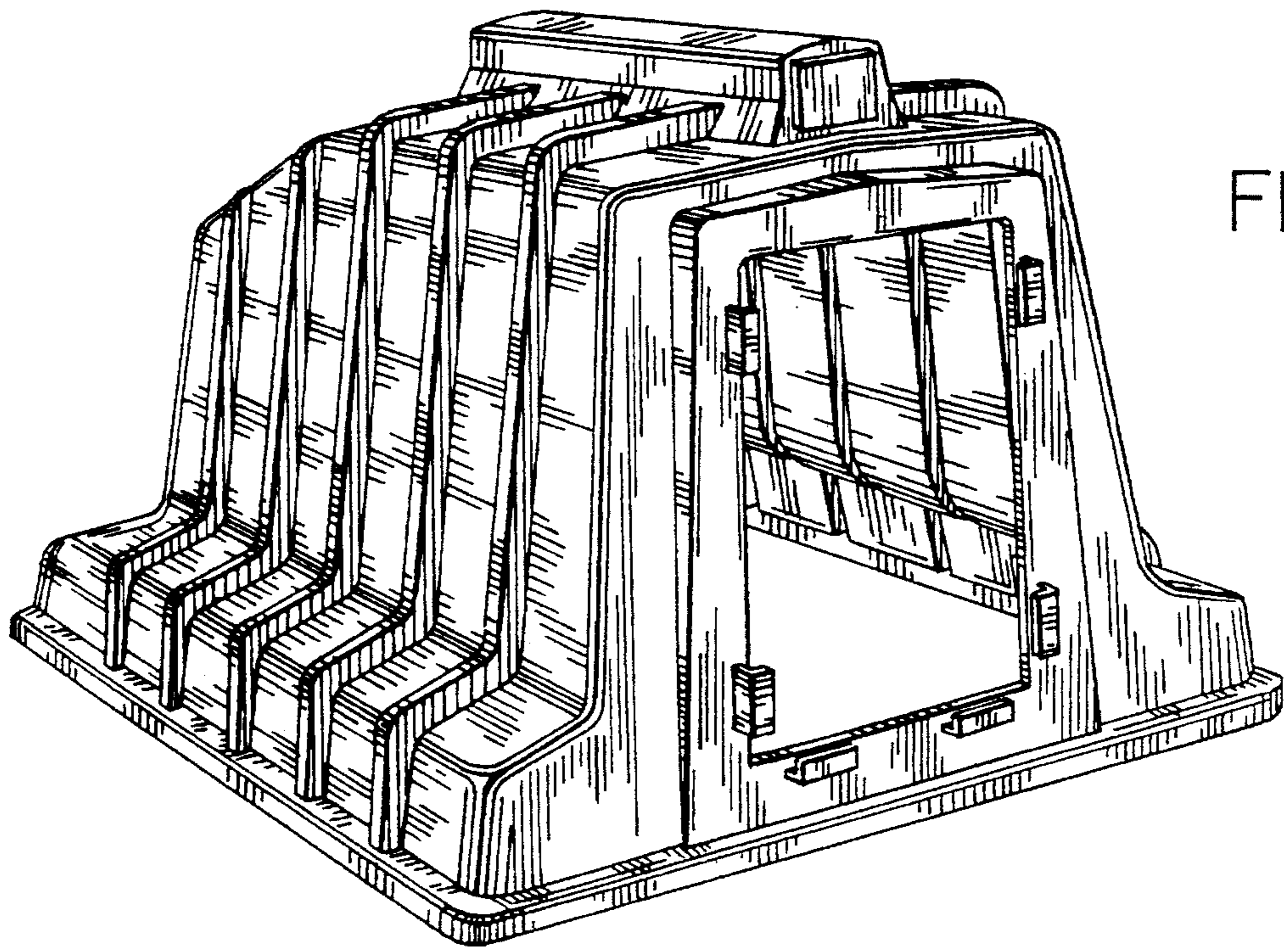

FIG. 1

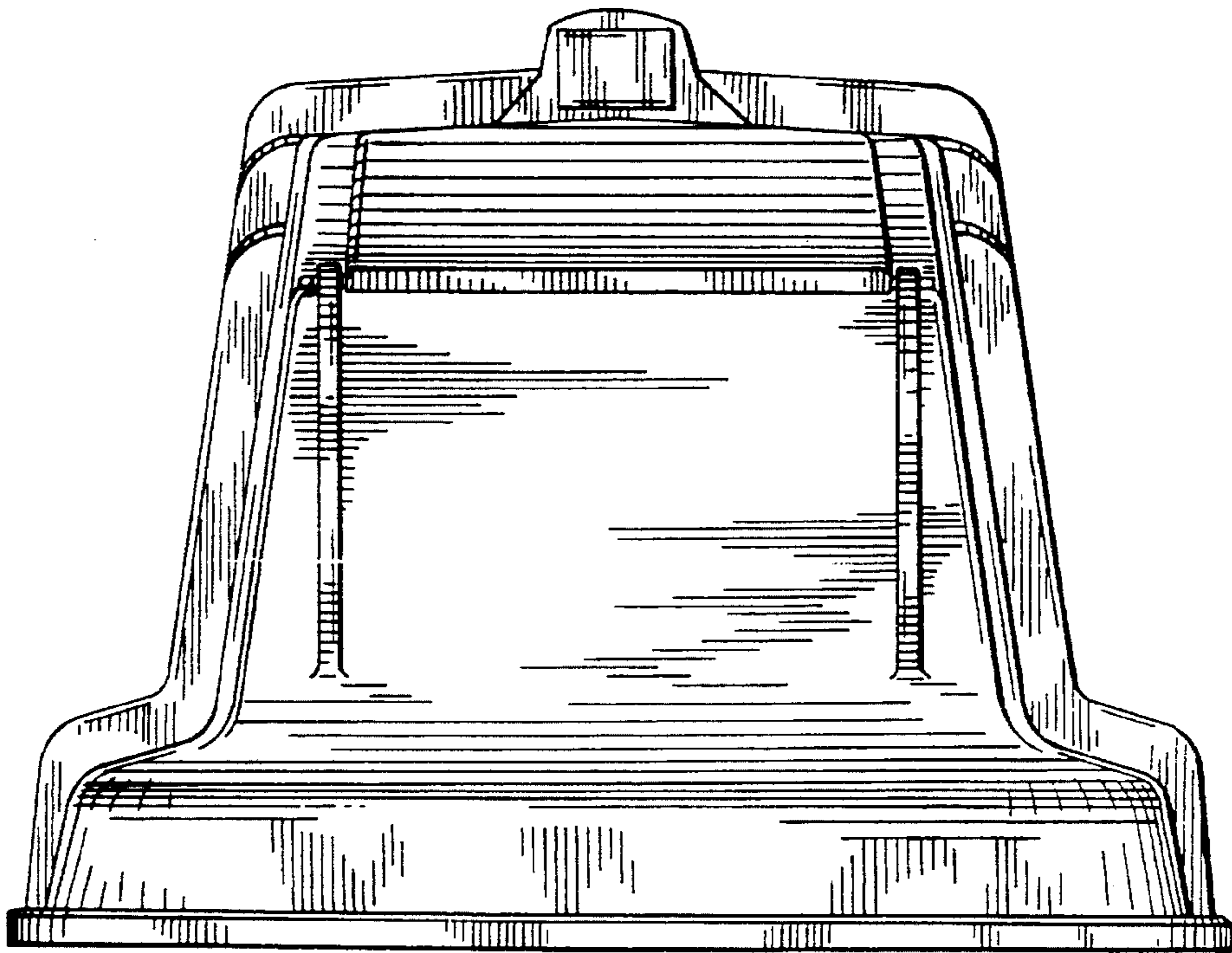

FIG. 2

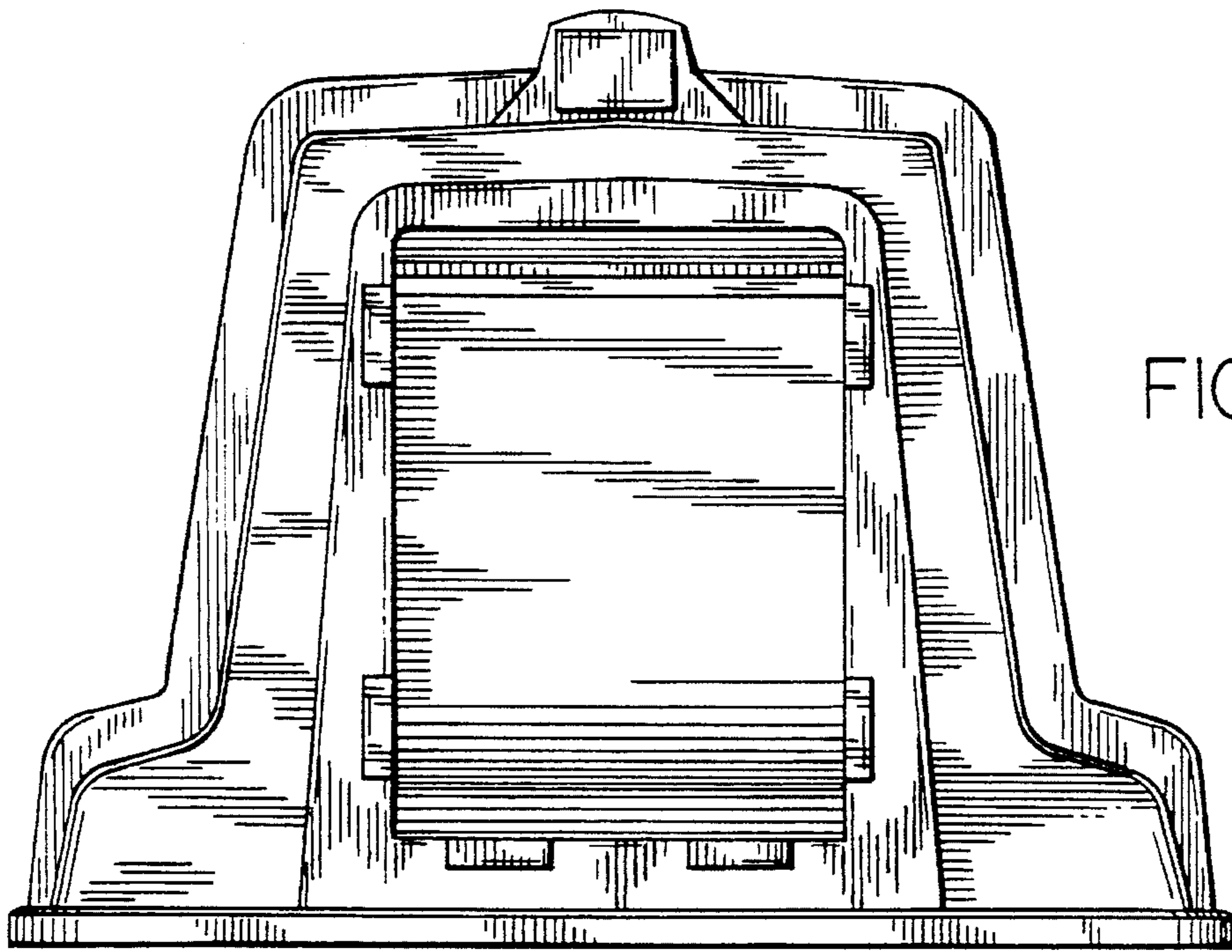

FIG. 3

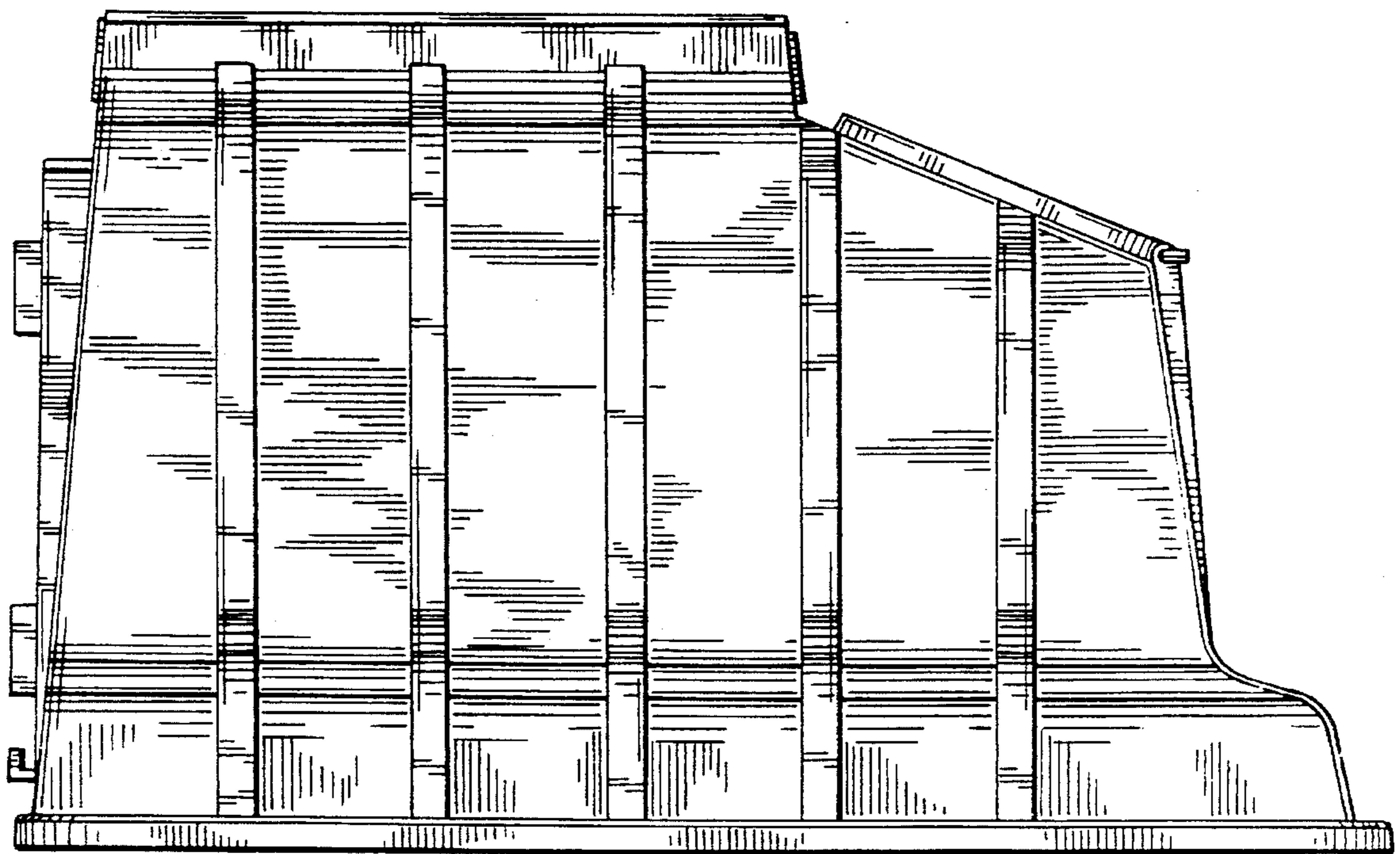

FIG. 4

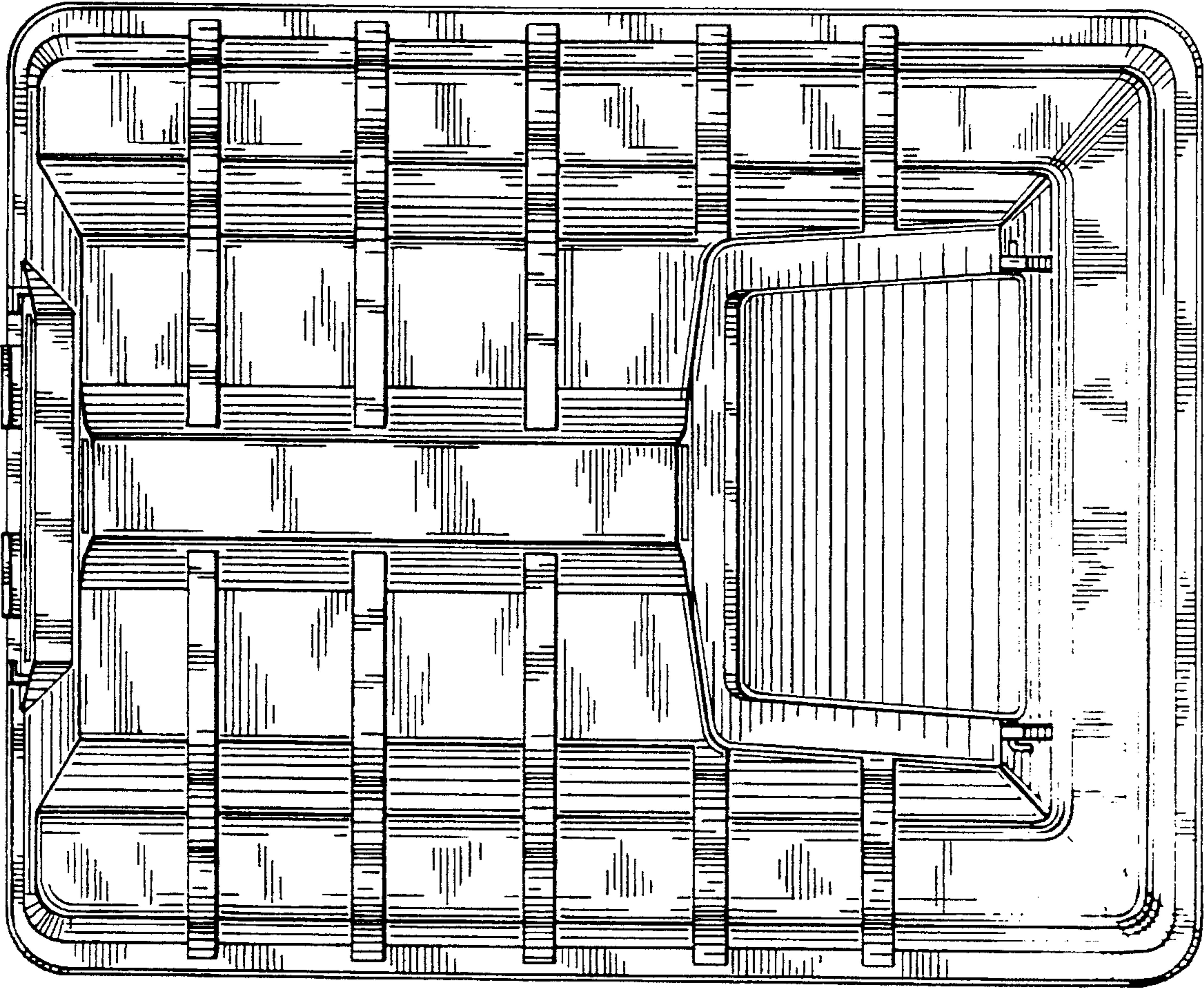

FIG. 5

FIG. 6

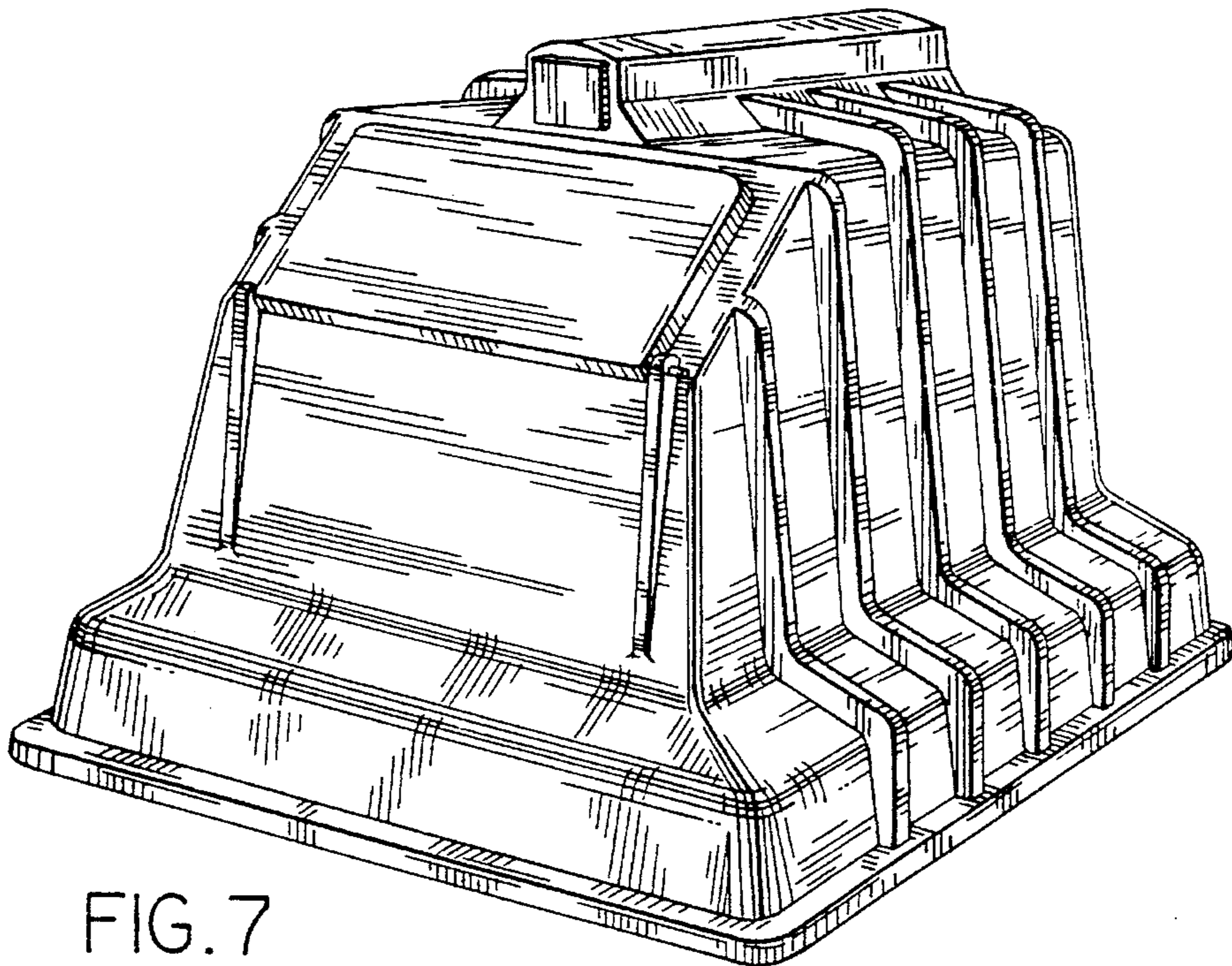
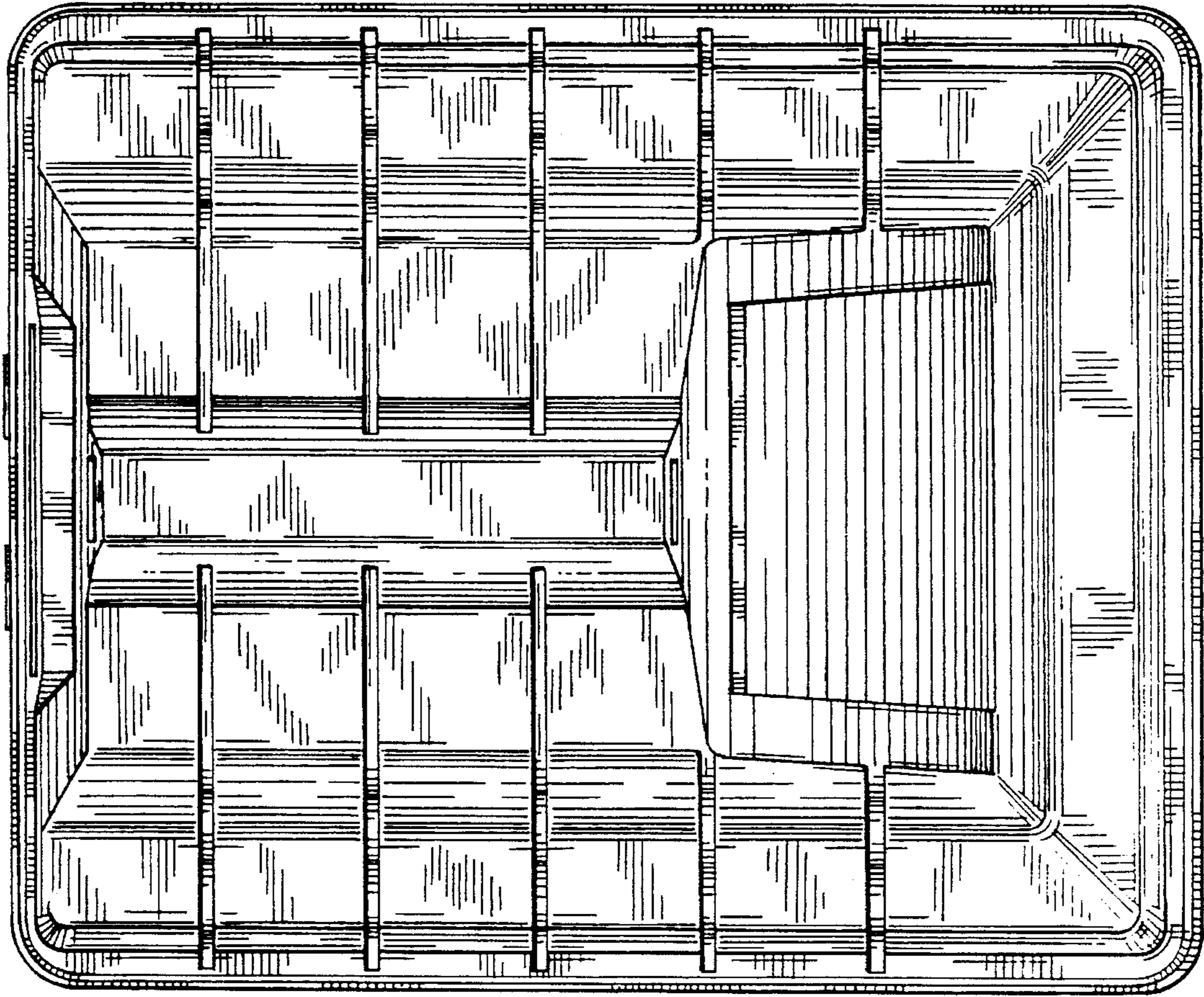

FIG. 7