



US00D363284S

# United States Patent [19] Solomita

[11] Patent Number: **Des. 363,284**  
[45] Date of Patent: **\*\*Oct. 17, 1995**

[54] **COMBINED TELEPHONE BASE AND SUPPORTING EASEL**

[75] Inventor: **Anthony Solomita**, Norwalk, Conn.

[73] Assignee: **Conair Corporation**, Stamford, Conn.

[\*\*] Term: **14 Years**

[21] Appl. No.: **29,216**

[22] Filed: **Sep. 30, 1994**

[52] U.S. Cl. .... **D14/149; D14/253**

[58] Field of Search ..... D13/107, 108;  
D14/140, 142, 137, 138, 149-151, 251-253,  
240, 241, 144; 379/454, 434, 455, 435,  
436, 440, 420, 419, 428

[56] **References Cited**

**U.S. PATENT DOCUMENTS**

|            |         |                       |           |
|------------|---------|-----------------------|-----------|
| D. 206,590 | 1/1967  | Haggstrom et al. .... | D13/108   |
| D. 268,342 | 3/1983  | Genaro et al. ....    | D14/137   |
| D. 271,971 | 12/1983 | Genaro et al. ....    | D14/149   |
| D. 275,482 | 9/1984  | Coons et al. ....     | D14/253   |
| D. 302,272 | 7/1989  | Sharp, Jr. ....       | D14/149 X |
| D. 304,338 | 10/1989 | Sermon ....           | D14/240   |
| D. 323,504 | 1/1992  | Langton ....          | D14/142   |

|            |         |                  |           |
|------------|---------|------------------|-----------|
| D. 343,841 | 2/1994  | Hon et al. ....  | D14/251   |
| D. 353,371 | 12/1994 | Delhaes ....     | D13/108   |
| 4,543,451  | 9/1985  | Schoen ....      | 379/434 X |
| 5,086,466  | 2/1992  | Gumb et al. .... | 379/454 X |

**OTHER PUBLICATIONS**

Fujitsu catalog page, AC Charger.

*Primary Examiner*—Jeffrey Asch

*Attorney, Agent, or Firm*—Haynes N. Johnson

[57] **CLAIM**

The ornamental design for a combined telephone base and supporting easel, as shown and described.

**DESCRIPTION**

FIG. 1 is a perspective view of a combined telephone base and supporting easel, showing my new design; FIG. 2 is a top plan view thereof; FIG. 3 is a right side elevation view thereof with the base and easel separated for convenience of illustration; FIG. 4 is a front elevation view thereof; FIG. 5 is a bottom plan view thereof; FIG. 6 is a left side elevation view thereof; and, FIG. 7 is a rear elevation view thereof.

**1 Claim, 2 Drawing Sheets**

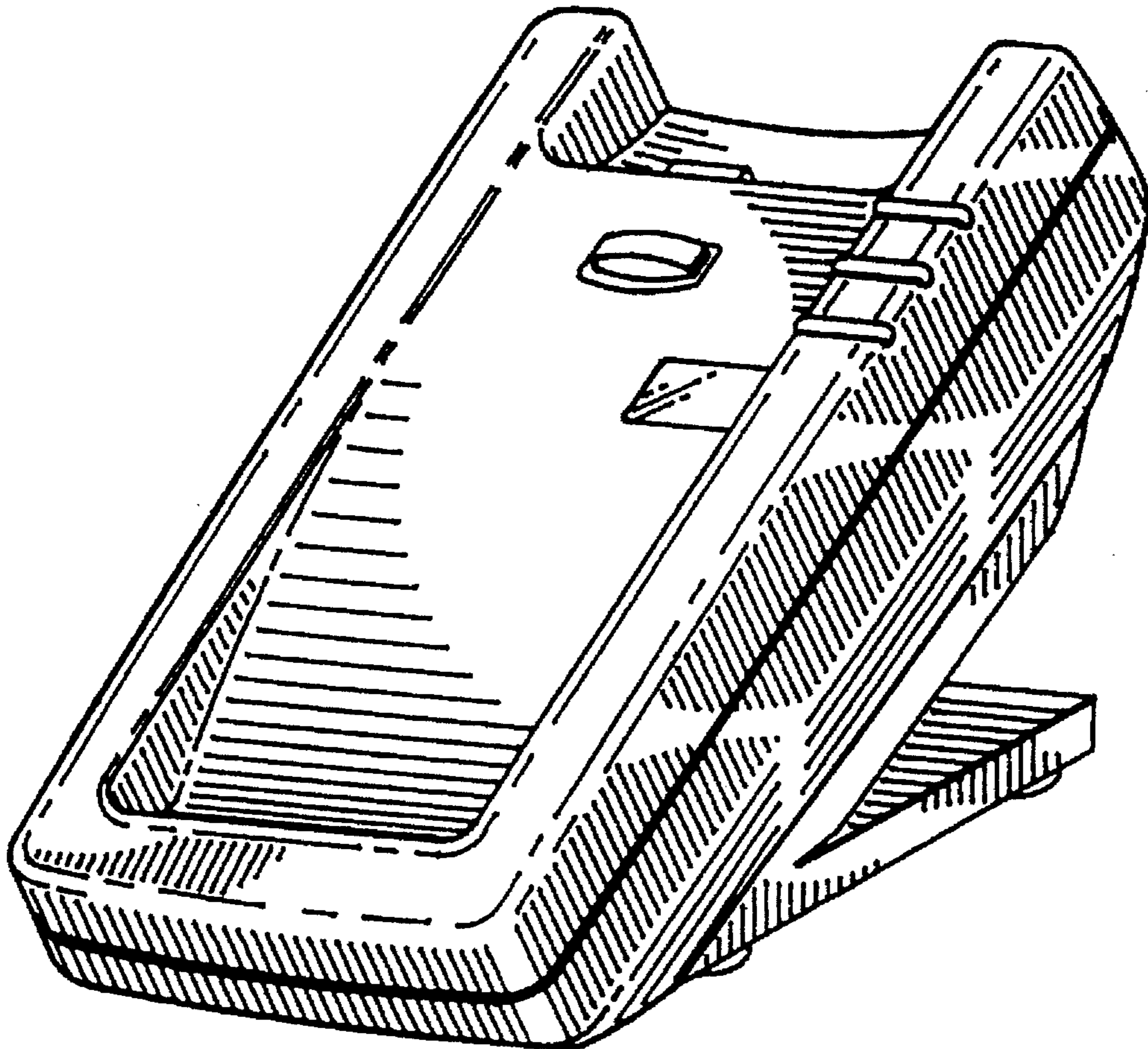

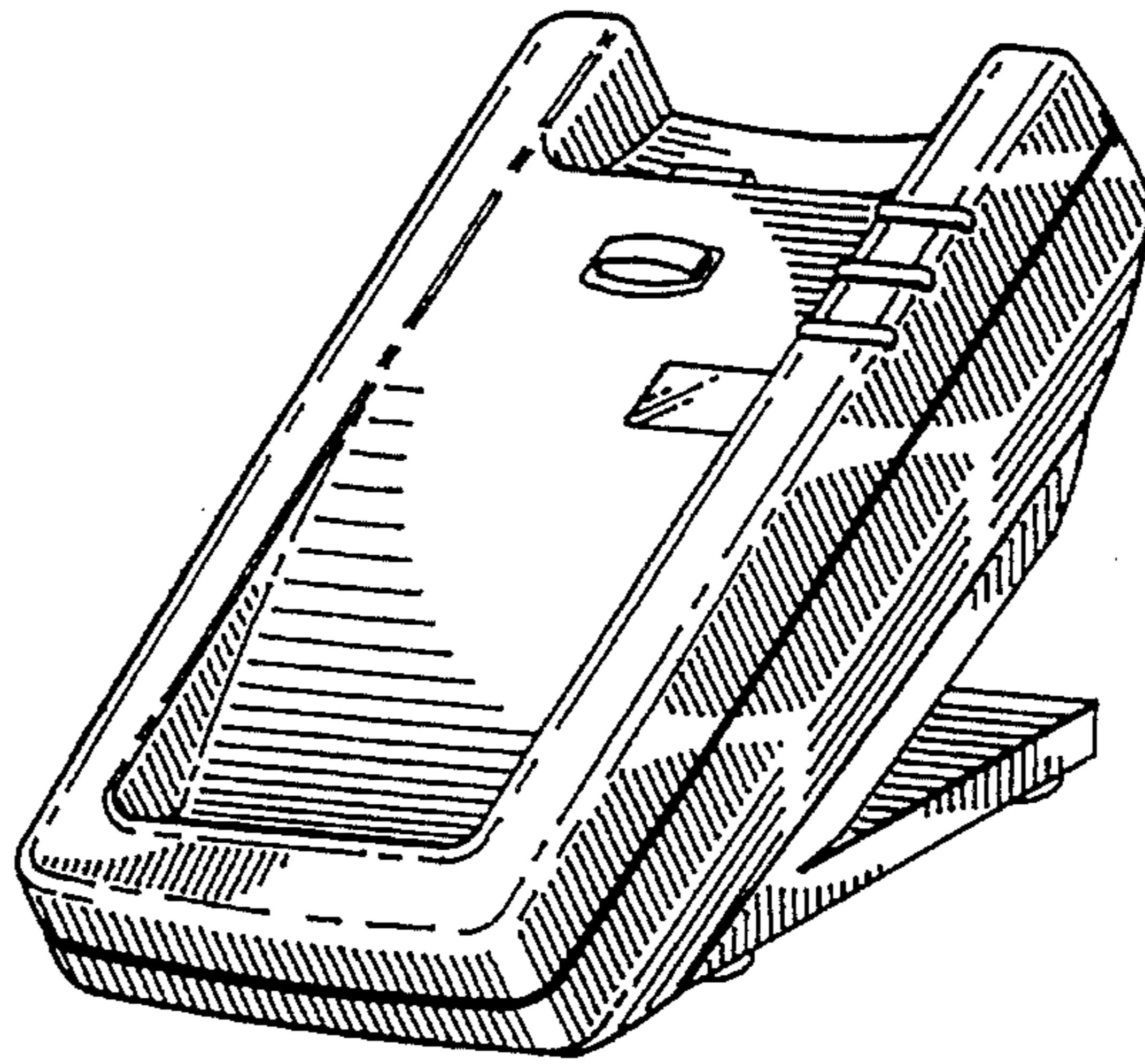

FIG. 1

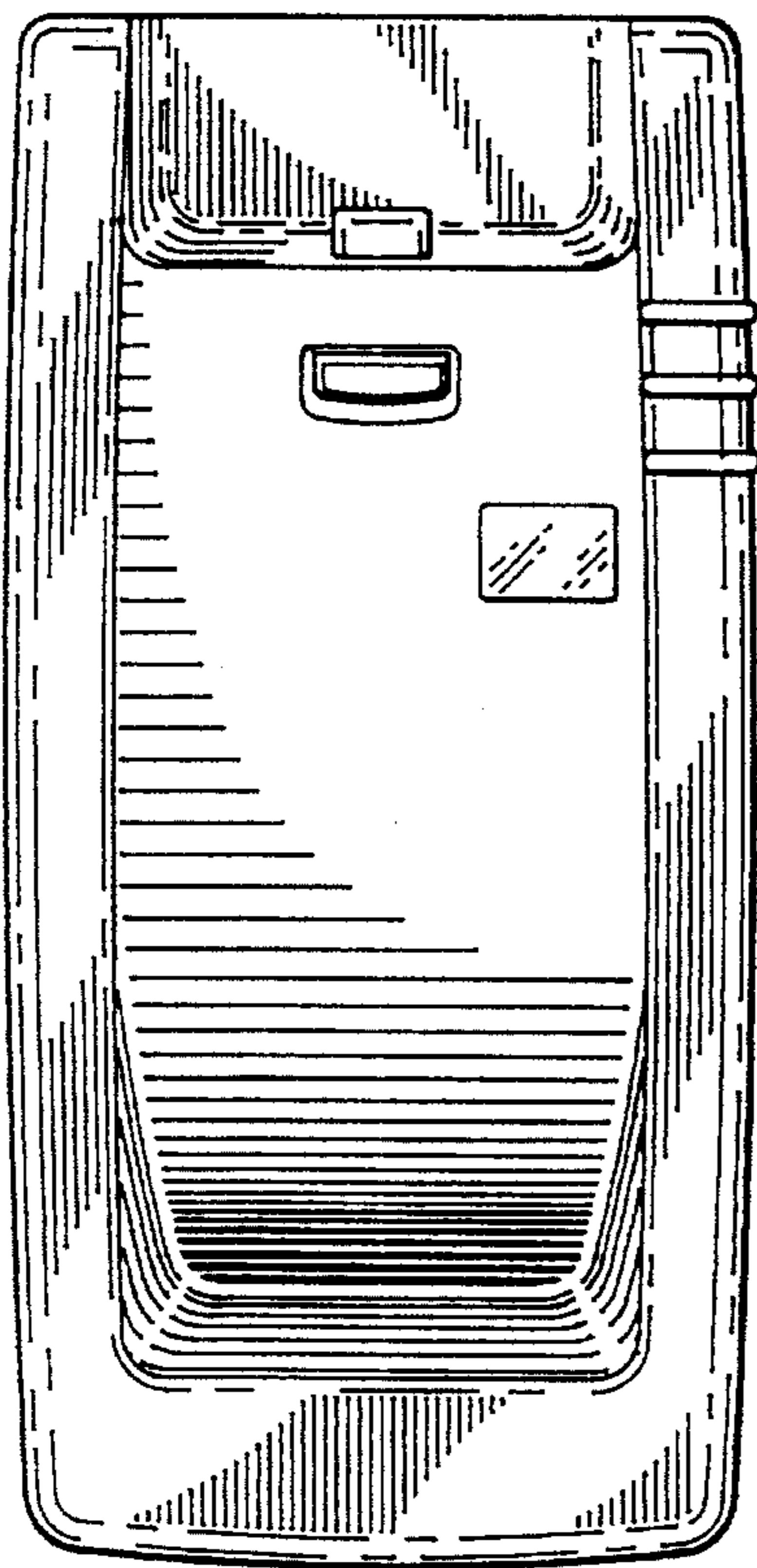

FIG. 2

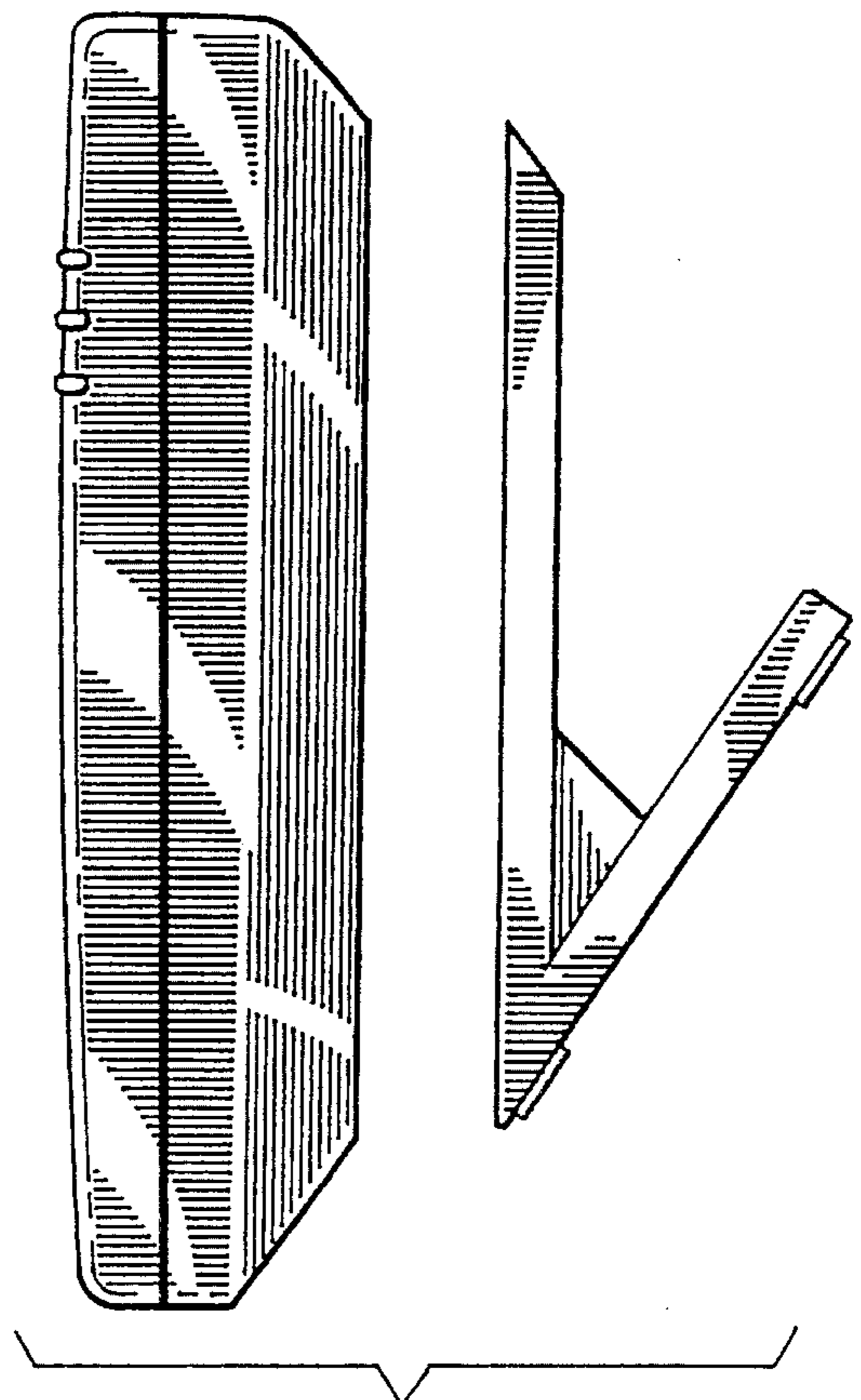

FIG. 3

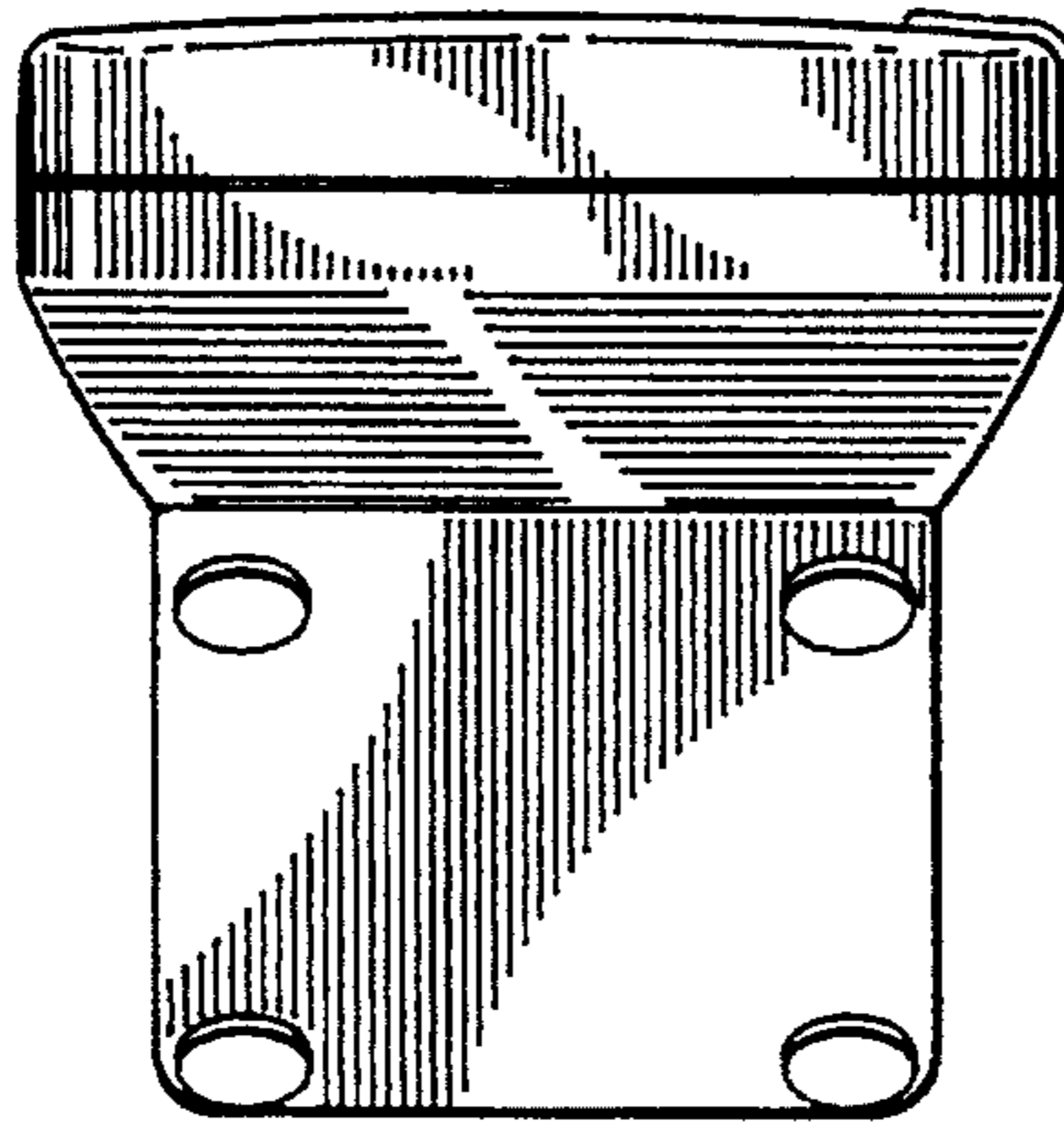

FIG. 4

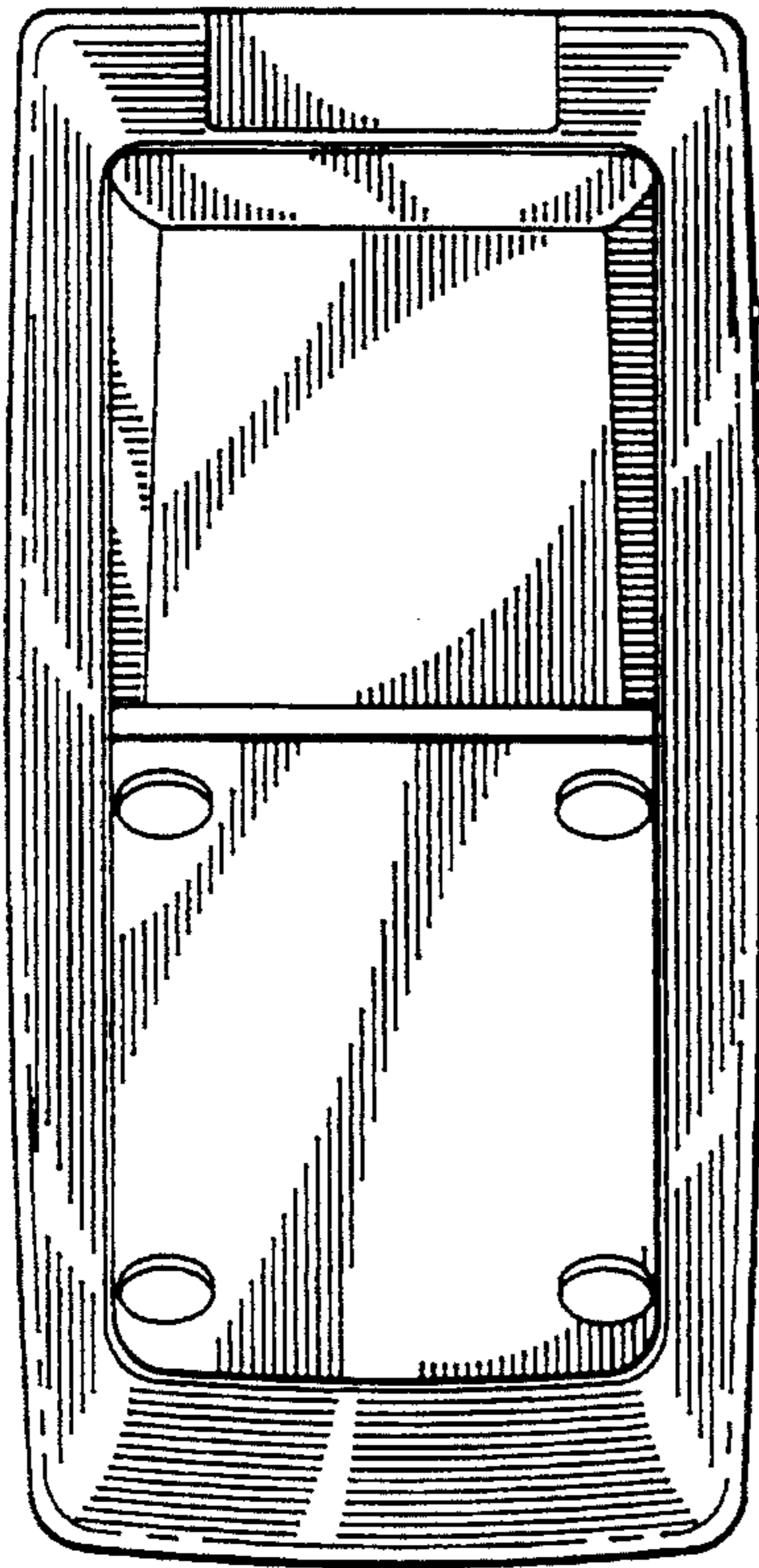

FIG. 5

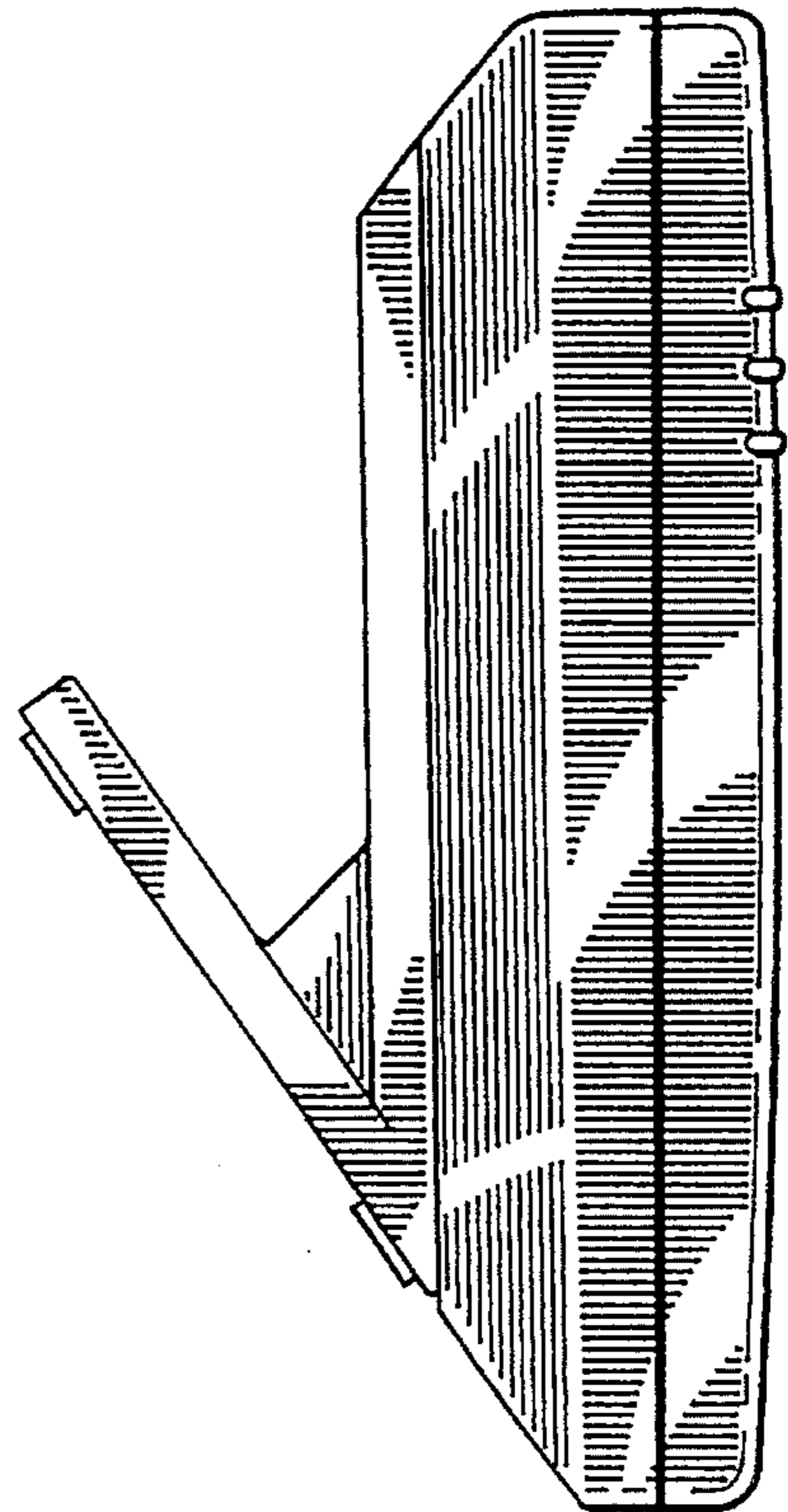

FIG. 6

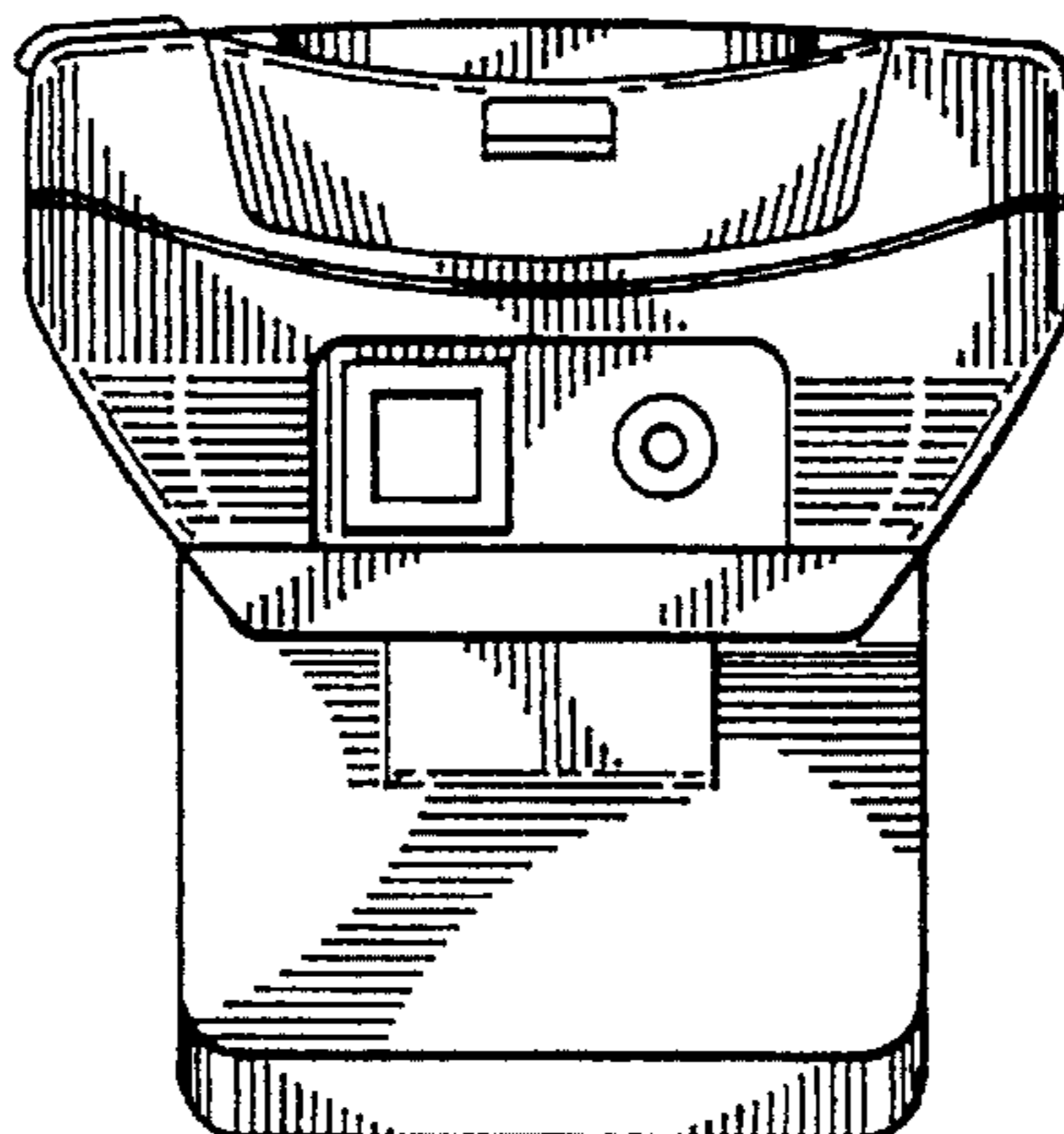

FIG. 7