



US00D363277S

United States Patent [19] Chung

[11] Patent Number: **Des. 363,277**

[45] Date of Patent: ****Oct. 17, 1995**

[54] **KEYBOARD WITH A TRACKBALL**

[75] Inventor: **Stephen Chung**, Taipei Hsien, Taiwan

[73] Assignee: **Silitek Corporation**, Taipei, Taiwan

[**] Term: **14 Years**

[21] Appl. No.: **16,463**

[22] Filed: **Dec. 17, 1993**

[52] U.S. Cl. **D14/115**

[58] Field of Search D14/100, 101,
D14/106, 115; D18/1, 2, 7; 235/145 A,
145 R; 200/5 A, 5 R, 6 A, 6 R; 345/168;
341/22, 23; 364/708.1; 400/472, 479, 484,
485, 486, 488, 489, 682

[56] **References Cited**

U.S. PATENT DOCUMENTS

- D. 338,665 8/1993 Riley et al. D14/115
- D. 340,445 10/1993 Marquardt et al. D14/115
- D. 348,453 7/1994 Riley et al. D14/115

OTHER PUBLICATIONS

Ergonomische Tastaturgestaltung (Design For An Ergonomic Keyboard).

Primary Examiner—Freda Nunn

Attorney, Agent, or Firm—Browdy and Neimark

[57] **CLAIM**

The ornamental design for a keyboard with a trackball, as shown and described.

DESCRIPTION

FIG. 1 is the enlarged perspective view of a design for a keyboard with a trackball showing my design; FIG. 2 is the front elevational view thereof; FIG. 3 is the rear elevational view thereof; FIG. 4 is the left side elevational view thereof; FIG. 5 is the right side elevational view thereof; FIG. 6 is the top plan view thereof; and, FIG. 7 is the bottom plan view thereof.

1 Claim, 4 Drawing Sheets

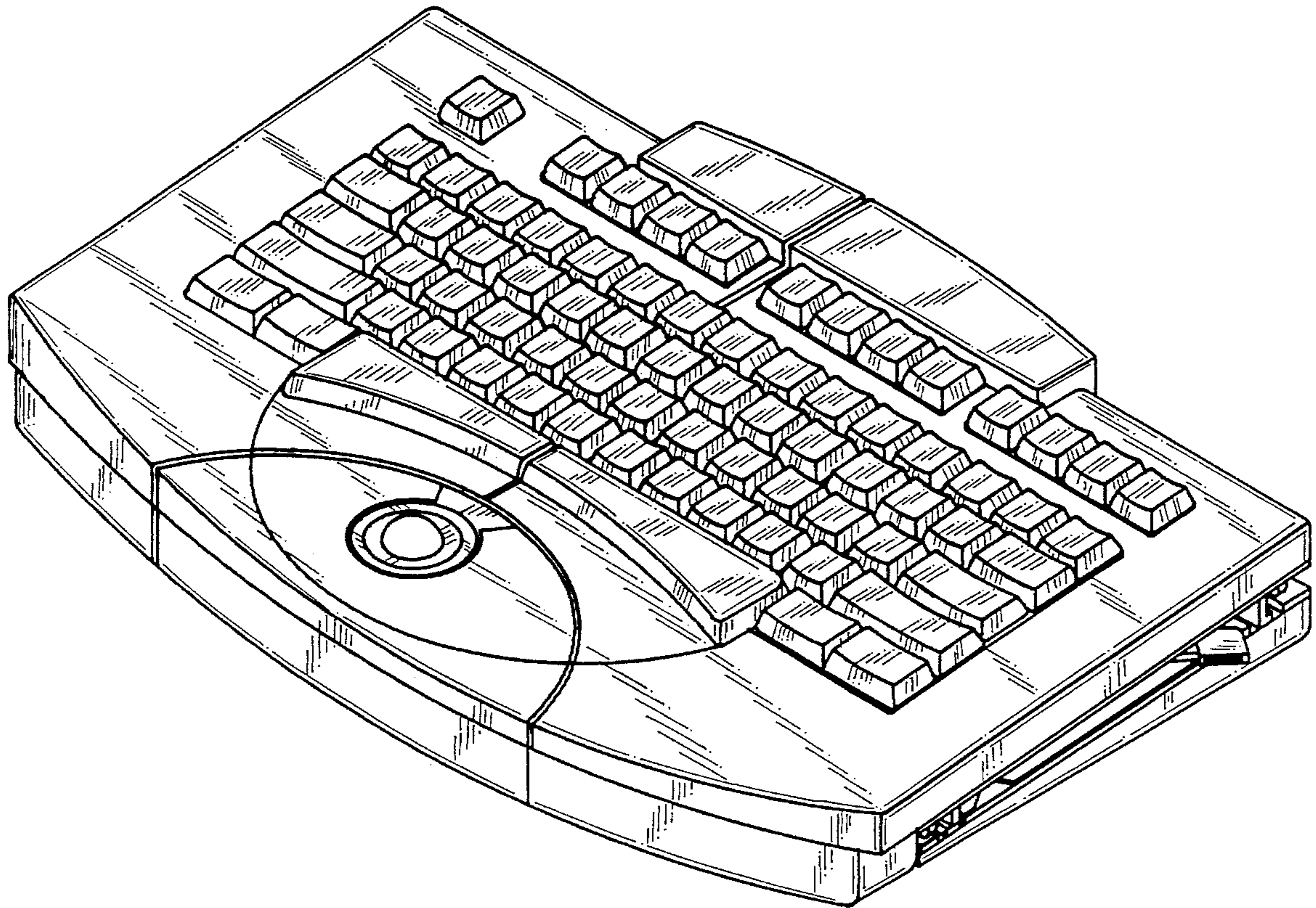

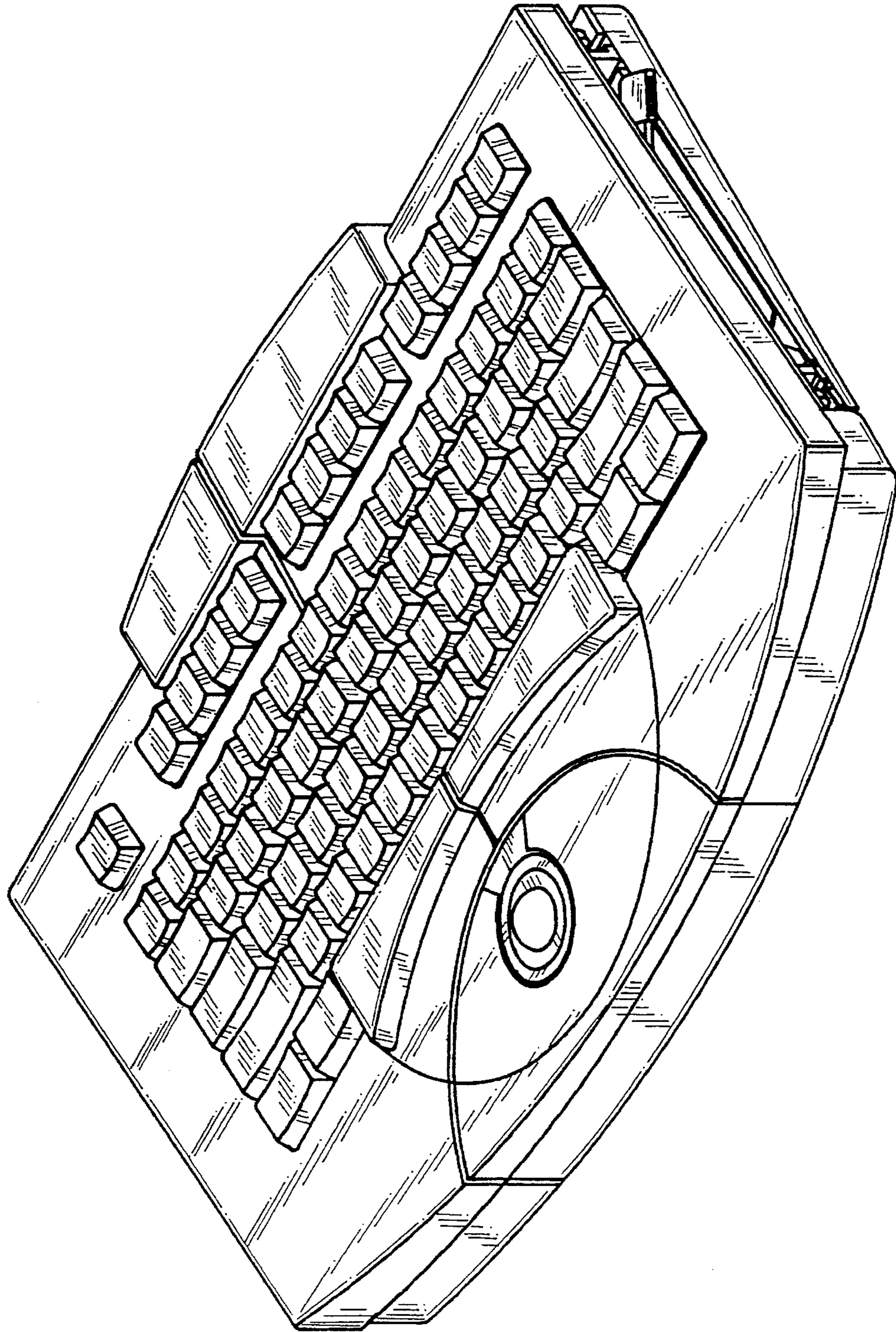

FIG. 1

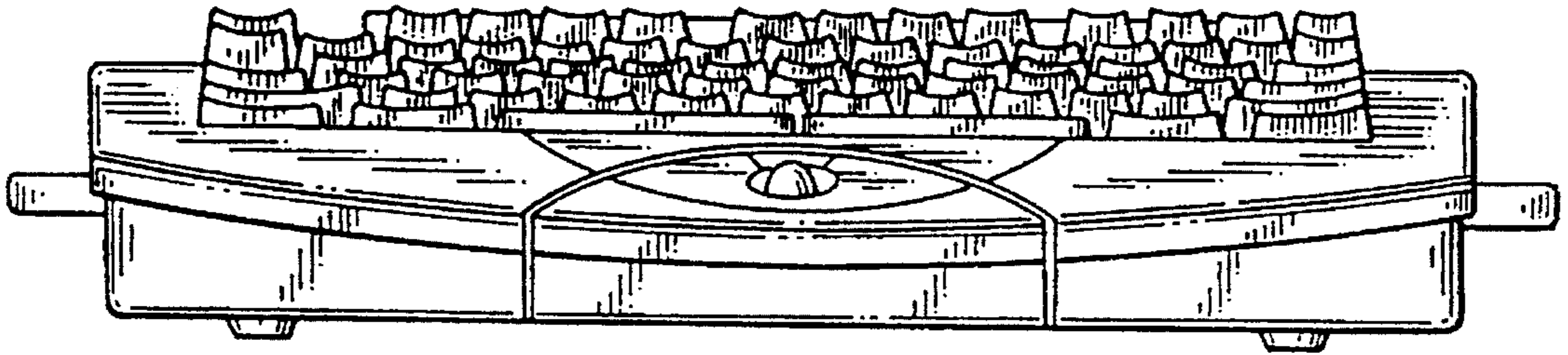

FIG. 2

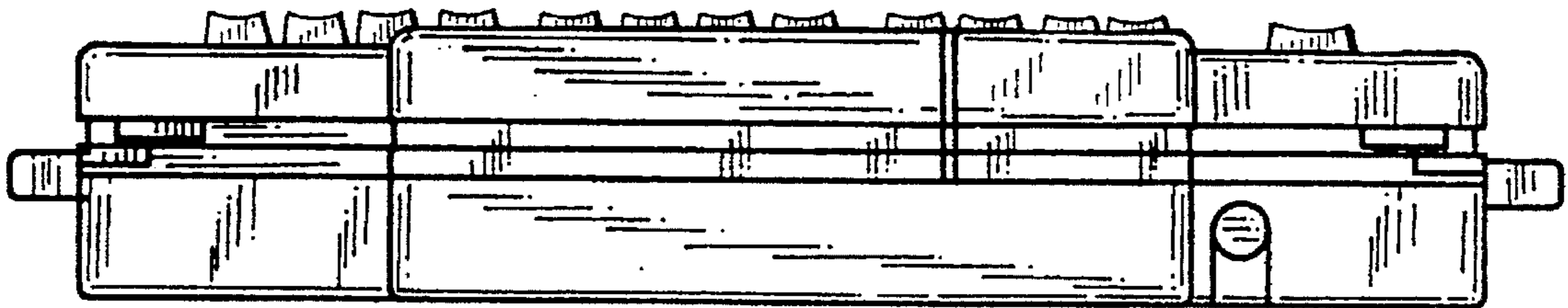

FIG. 3

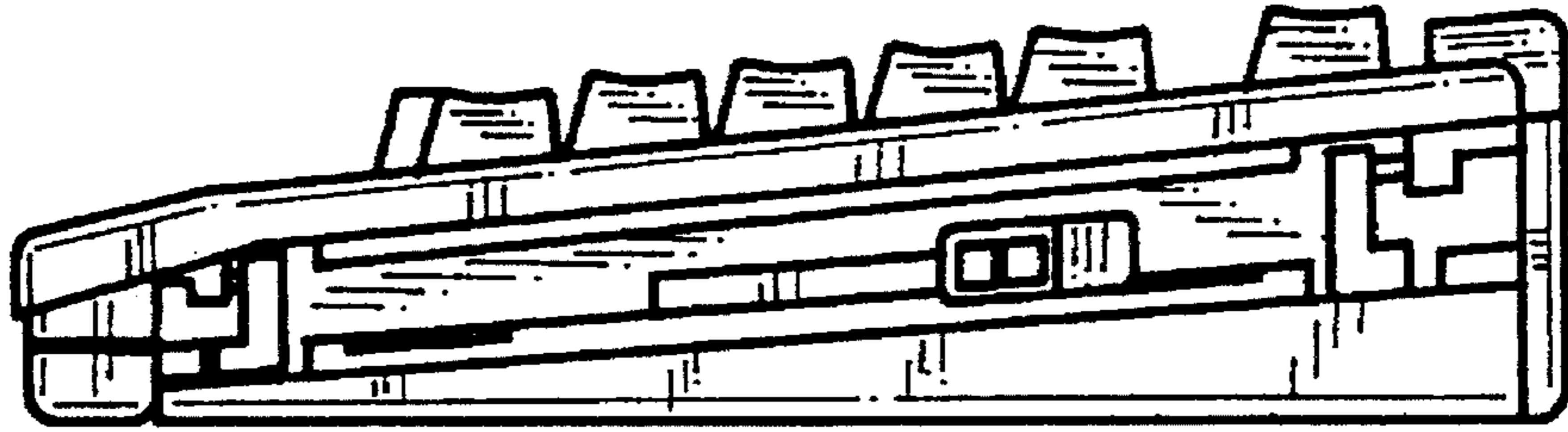

FIG.5

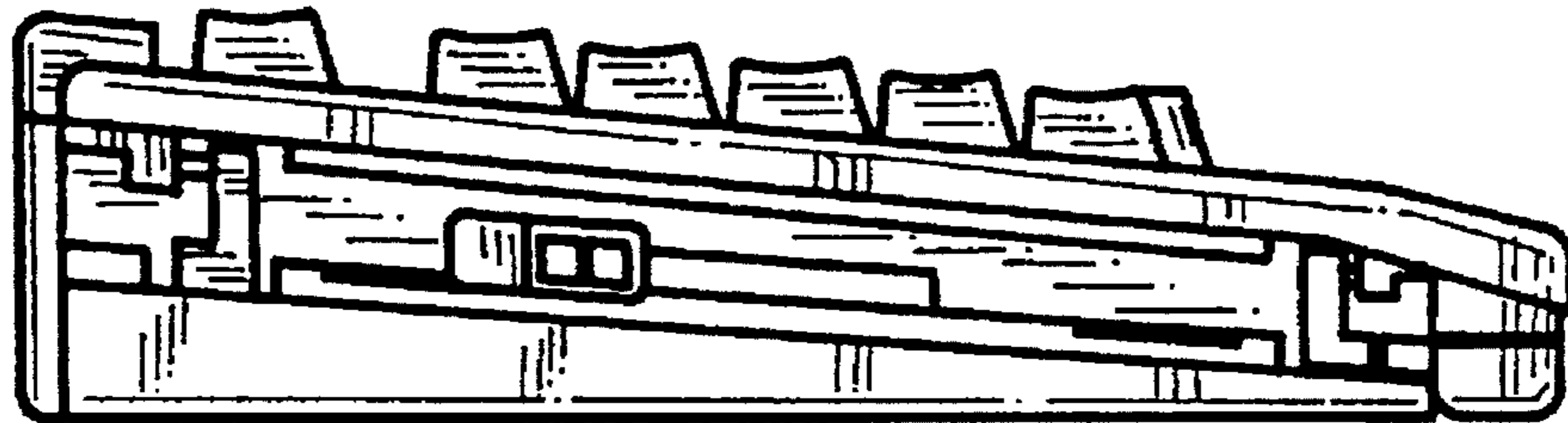

FIG.4

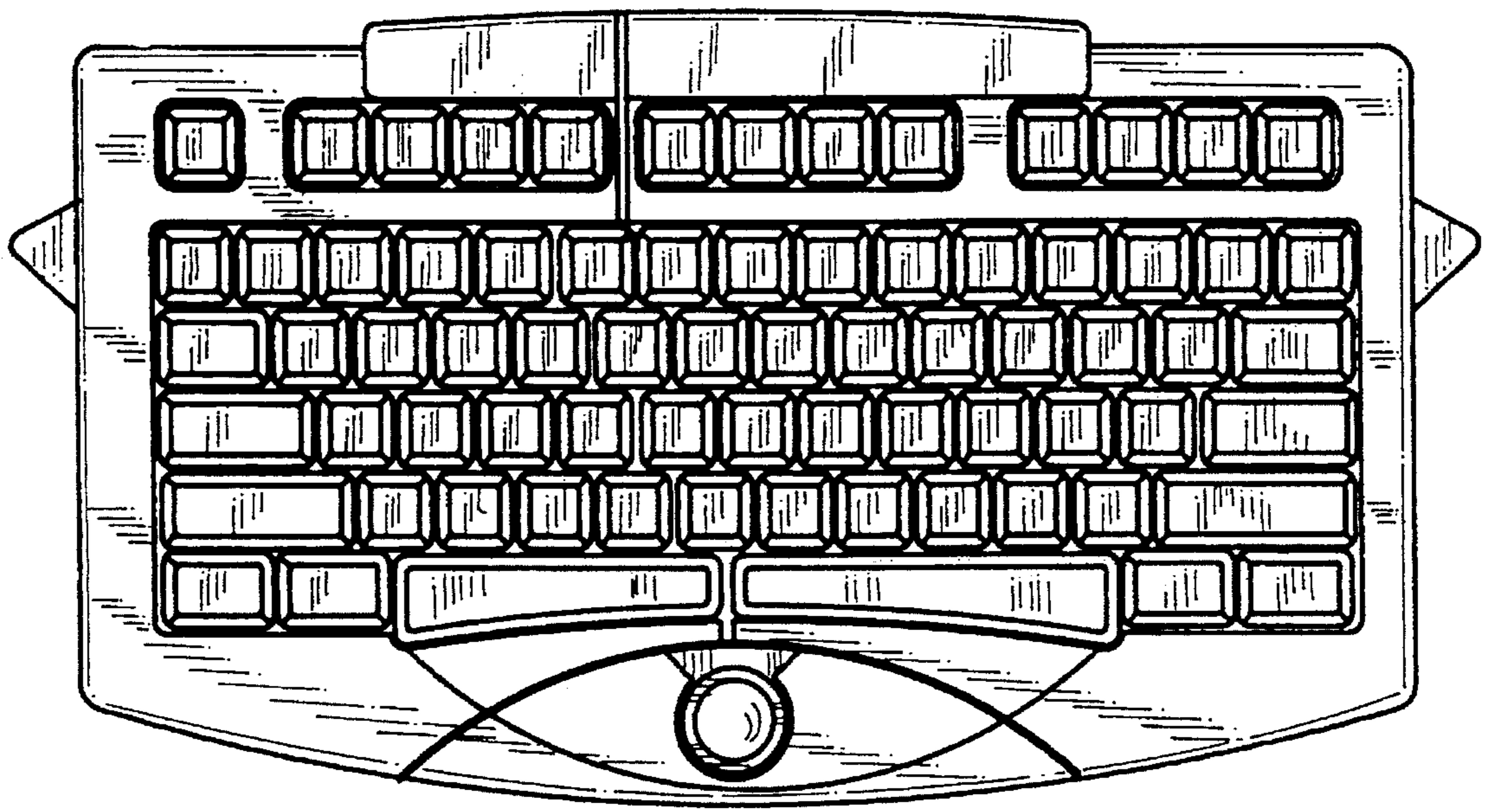

FIG. 6

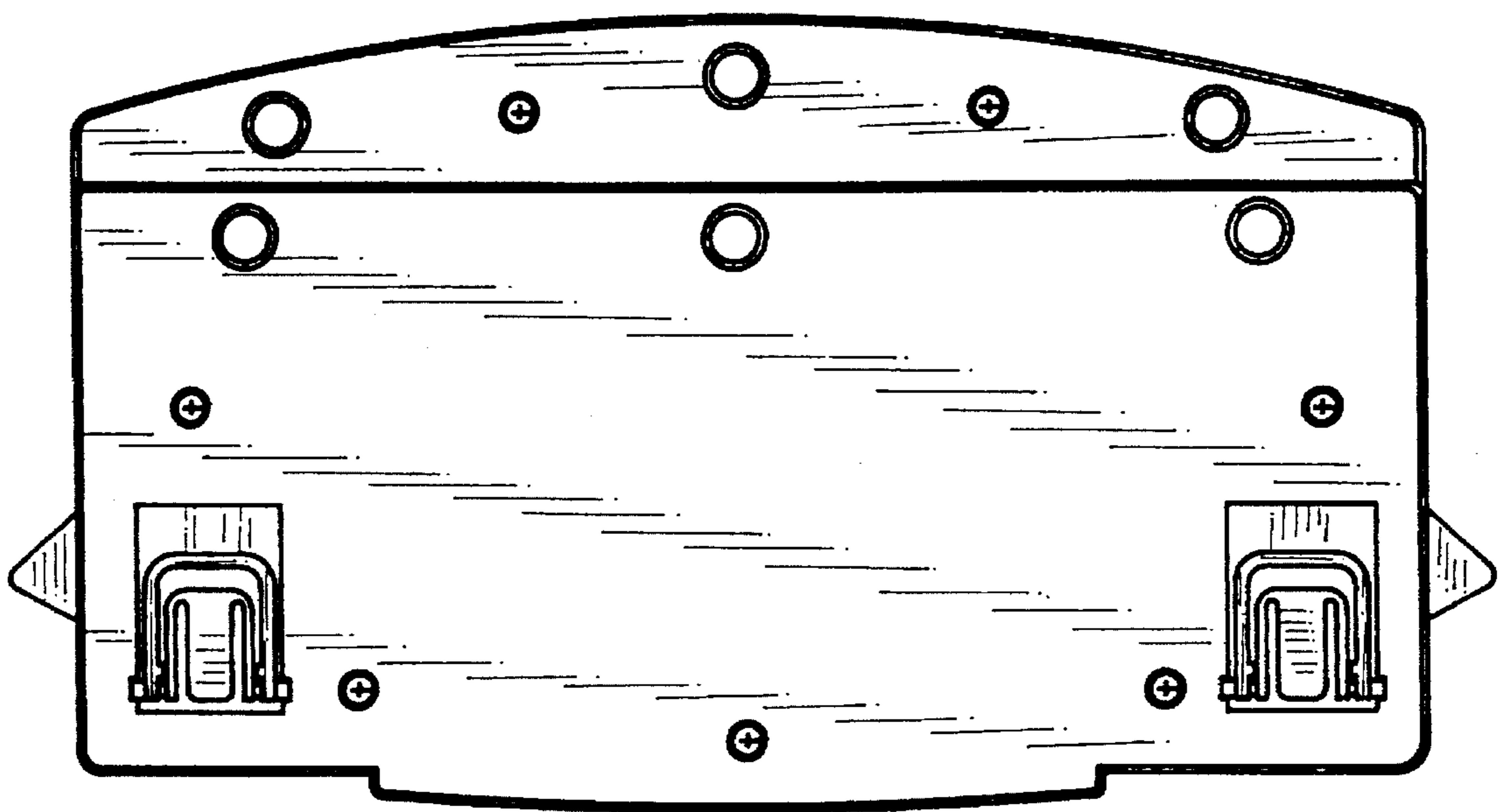

FIG. 7