



US00D363205S

**United States Patent** [19]  
**Glenn**

[11] **Patent Number: Des. 363,205**  
[45] **Date of Patent: \*\*Oct. 17, 1995**

[54] **HANDLE**  
[75] Inventor: **Robert D. Glenn**, North Haven, Conn.  
[73] Assignee: **Sargent Manufacturing Company**,  
New Haven, Conn.  
[\*\*] Term: **14 Years**  
[21] Appl. No.: **12,367**  
[22] Filed: **Aug. 30, 1993**  
[52] U.S. Cl. .... **D8/308**  
[58] **Field of Search** ..... D8/300, 301, 302,  
D8/308; 16/110 R, 111 R, 124; 70/207,  
215; 74/523; 292/347

[56] **References Cited**  
**U.S. PATENT DOCUMENTS**  
5,265,924 11/1993 Kim ..... 292/347

**OTHER PUBLICATIONS**  
Assa. Inc. Cat.; ©1986; p. 12; Lever 650.  
Industrial Design; Jun. 1963; p. 11; Locking Lever.

*Primary Examiner*—B. J. Bullock

*Attorney, Agent, or Firm*—DeLio & Peterson

[57] **CLAIM**

The ornamental design for a handle, as shown and described.

**DESCRIPTION**

FIG. 1 is a perspective view of the handle according to the present design;  
FIG. 2 is a top plan view of the handle shown in FIG. 1, the bottom view of the handle being a mirror image;  
FIG. 3 is a front elevational view of the handle shown in FIG. 1;  
FIG. 4 is a back elevational view of the handle shown in FIG. 1;  
FIG. 5 is a side elevational view of the handle shown in FIG. 1 looking from the right end of the drawing;  
FIG. 6 is a side elevational view of the handle shown in FIG. 1 looking from the left end of the drawing;  
FIG. 7 is a back elevational view of a second embodiment of the handle shown in FIG. 1, the only difference being the configuration of the inner surface of the handle; and,  
FIG. 8 is a sectional view taken in the direction of the arrows on line 8—8 of the handle shown in FIG. 7.

**1 Claim, 3 Drawing Sheets**

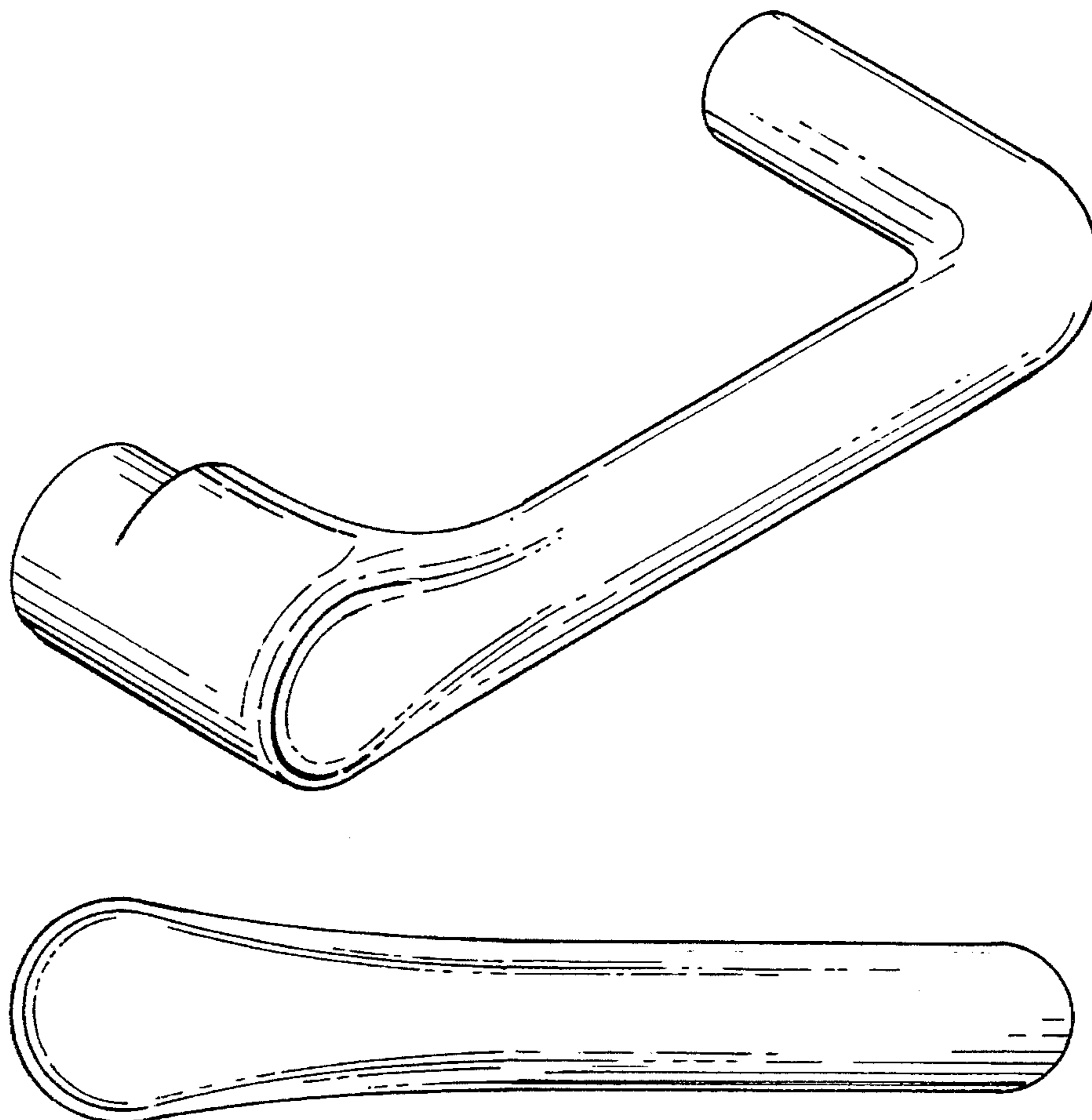

FIG. 1

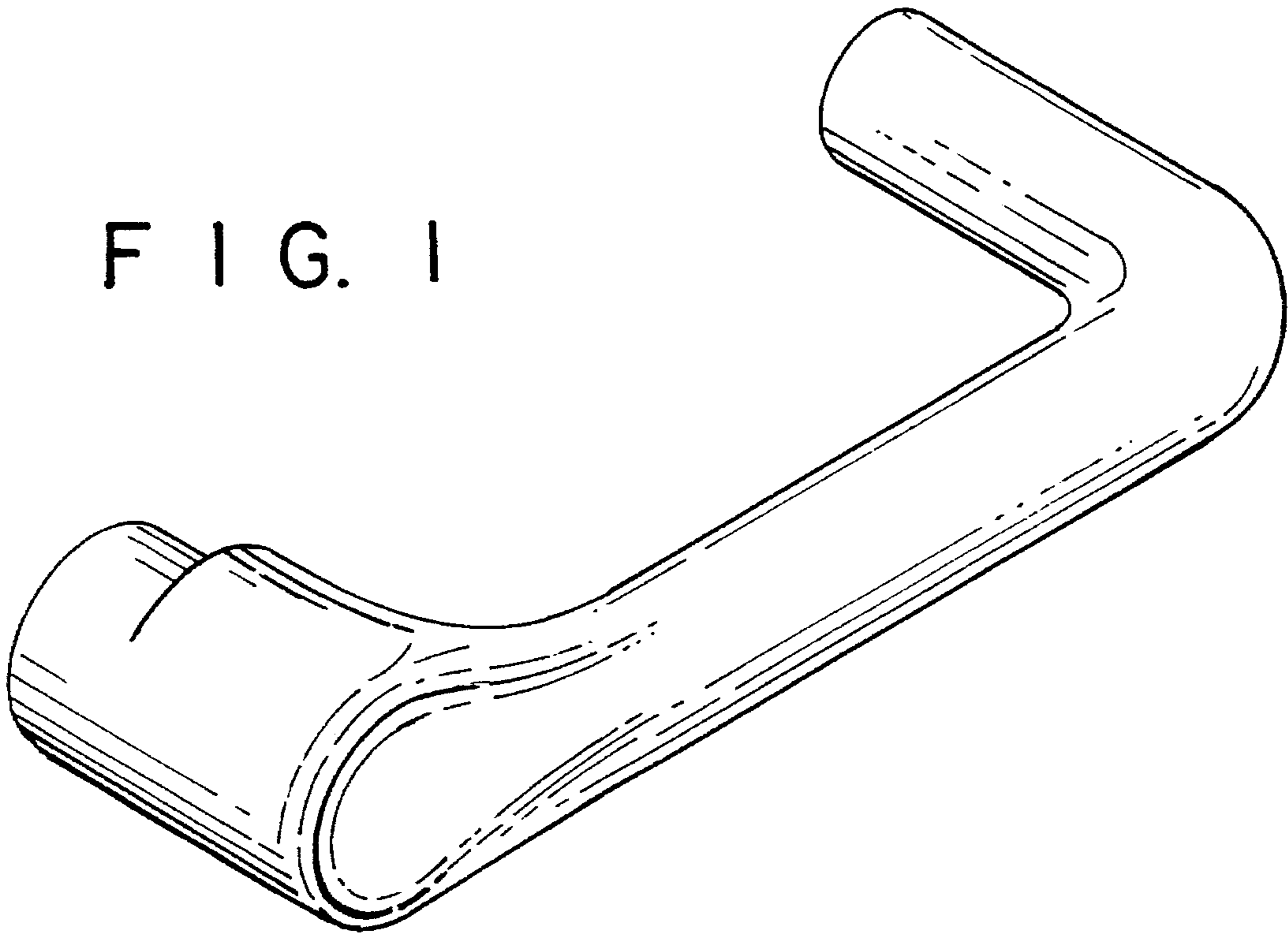

FIG. 2

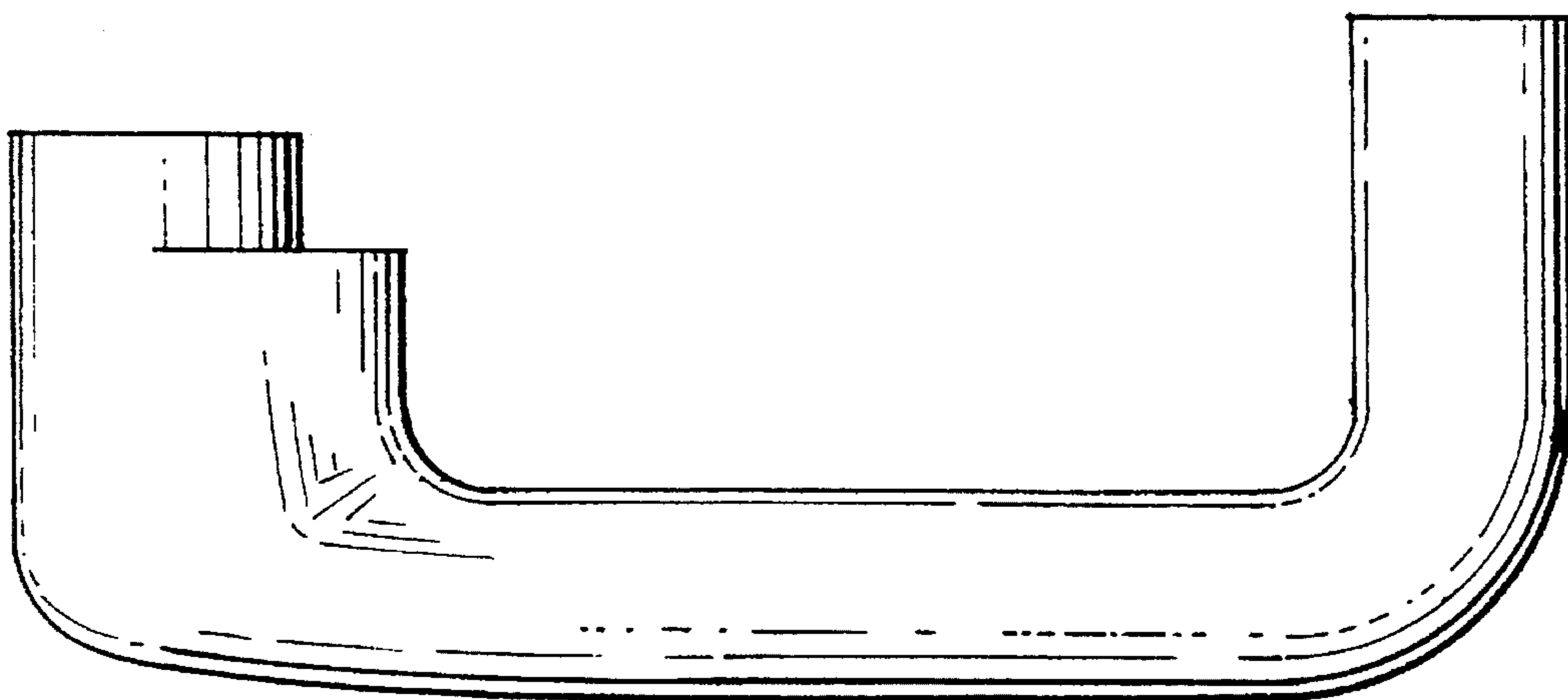

FIG. 3

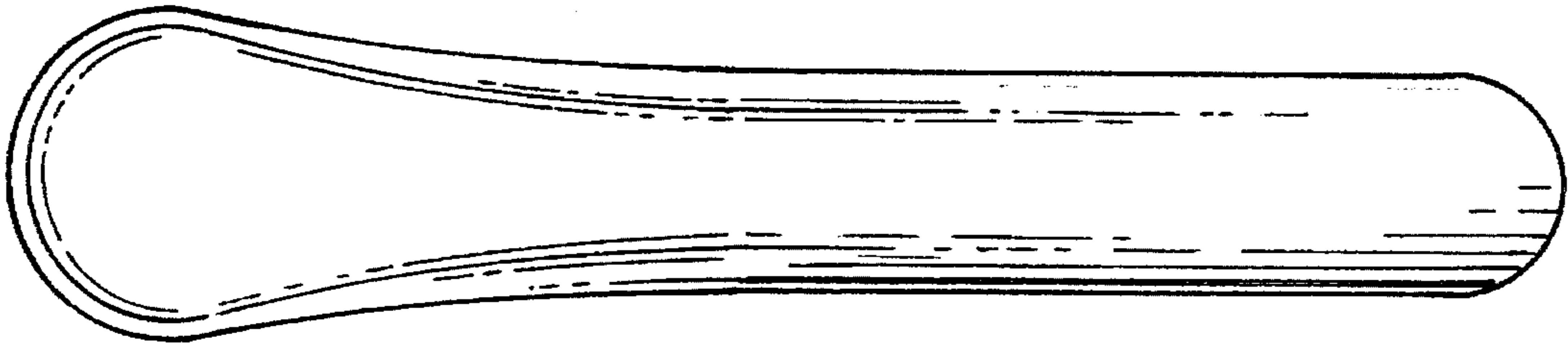

FIG. 4

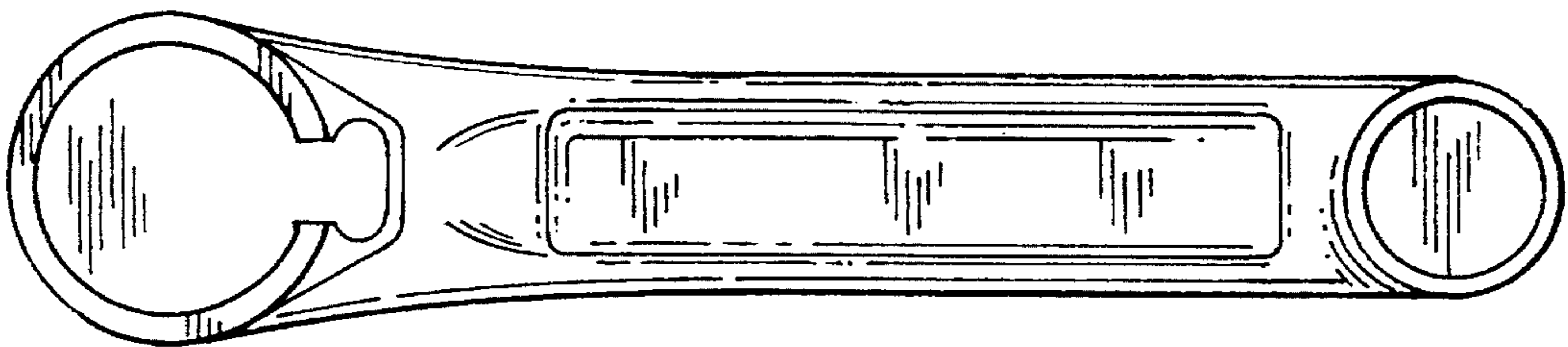

FIG. 5

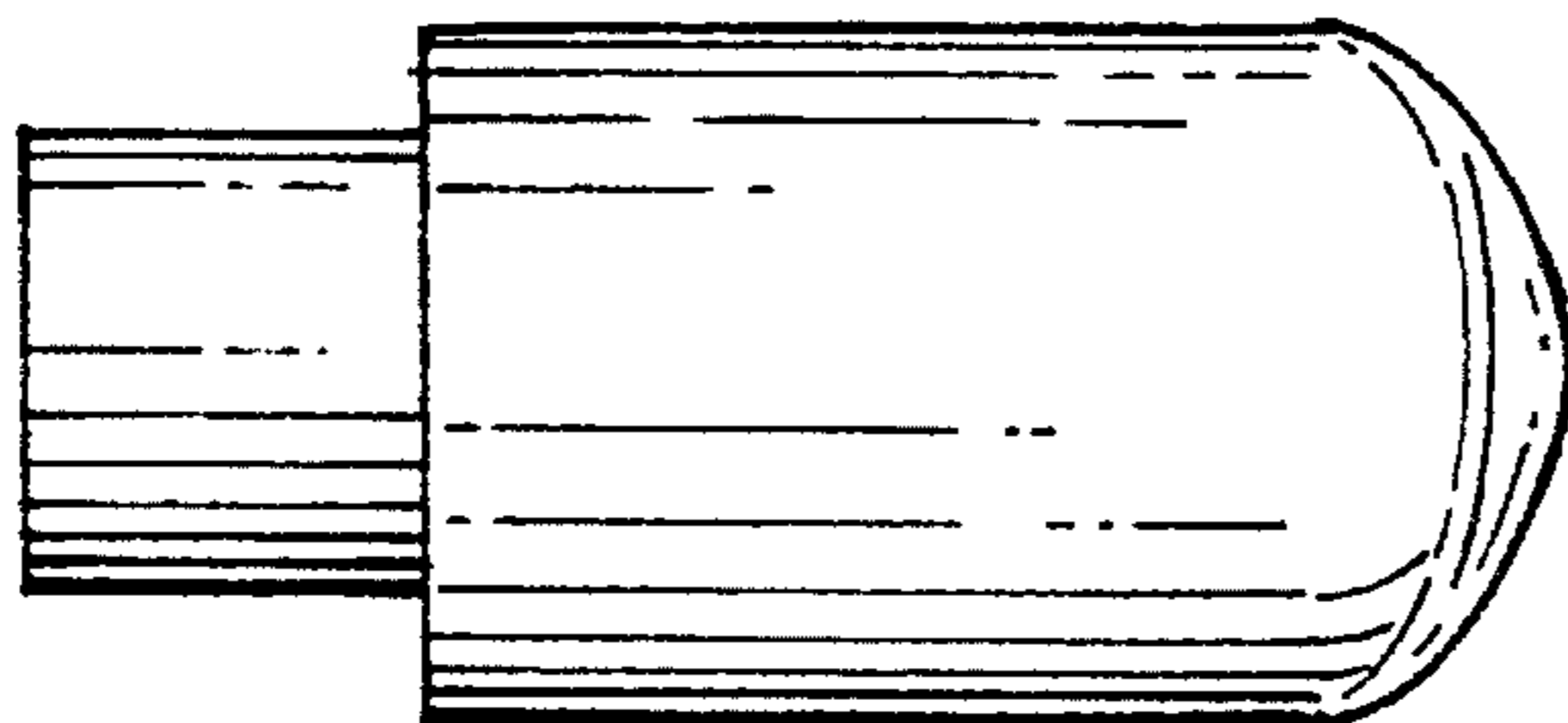
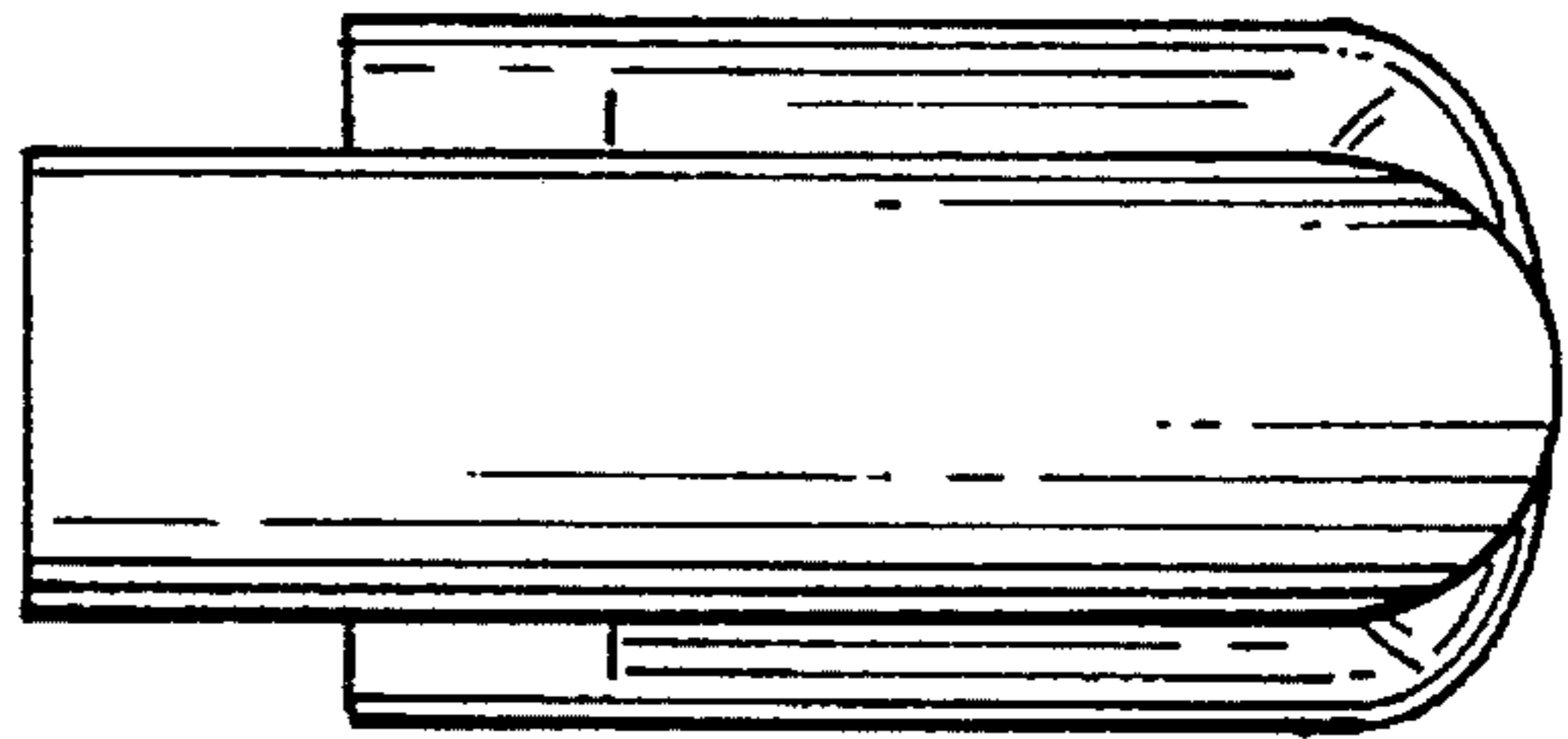

FIG. 6

FIG. 8

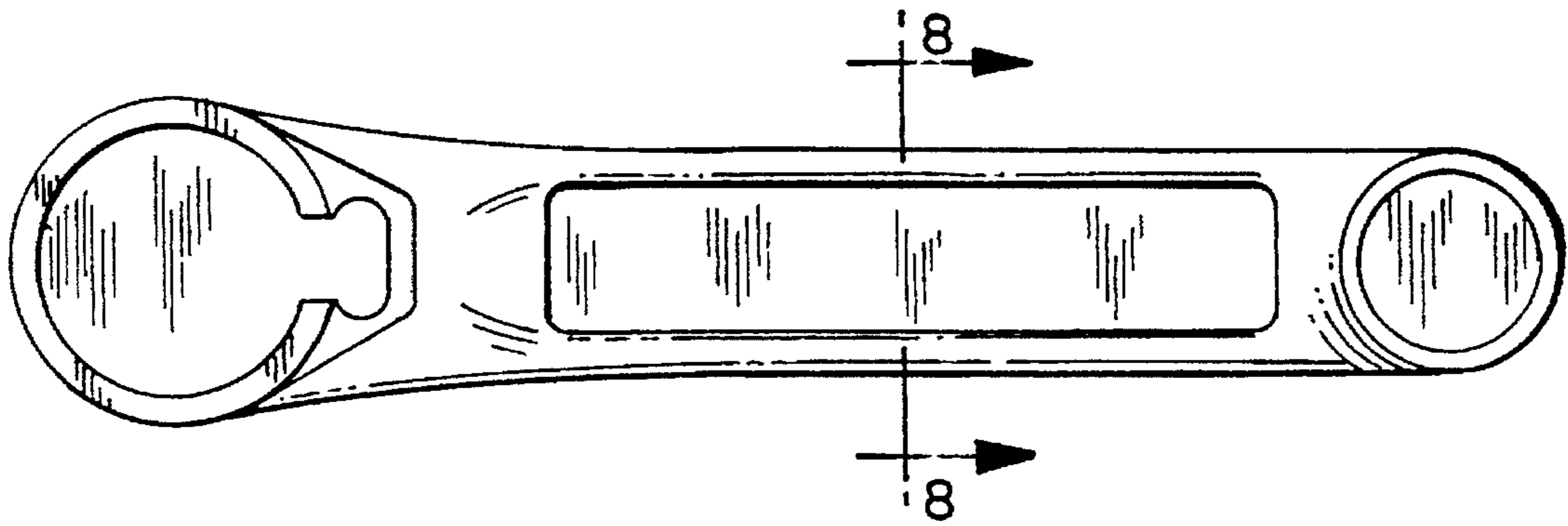
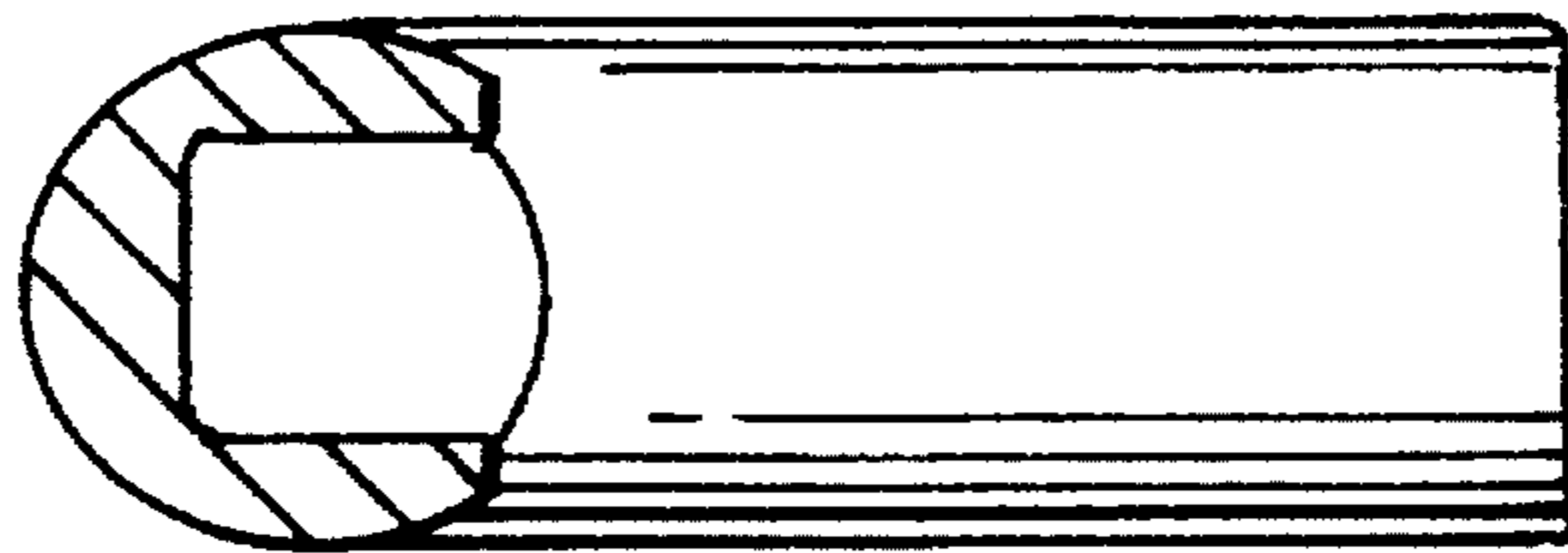

FIG. 7