



US00D363199S

United States Patent [19]
Domagala

[11] **Patent Number: Des. 363,199**
[45] **Date of Patent: **Oct. 17, 1995**

[54] **ARROW HEAD PULLING TOOL**
[76] Inventor: **Tracey J. Domagala**, 287 7th St. SW.
#4, Dickinson, N. Dak. 58601
[**] Term: **14 Years**
[21] Appl. No.: **19,768**
[22] Filed: **Mar. 11, 1994**
[52] U.S. Cl. **D8/51**
[58] **Field of Search** D8/14, 51; 173/90,
173/91, 128; 7/170; 254/131; 29/264

4,675,968 6/1987 Bartlett 29/254
4,920,625 5/1990 Smith 29/264
5,025,867 6/1991 Muller 173/90
5,113,687 5/1992 Palmgren 72/479
5,201,211 4/1993 Golembreski 72/463
5,205,541 4/1993 Roberts et al. 254/131

Primary Examiner—Terry A. Wallace
Assistant Examiner—Philip Hyder

[57] **CLAIM**

The ornamental design for an arrow head pulling tool, as shown and described.

DESCRIPTION

FIG. 1 is an enlarged front elevational view of the arrow head pulling tool showing my new design;
FIG. 2 is an enlarged rear elevational view thereof;
FIG. 3 is a left side elevational view thereof;
FIG. 4 is a right side elevational view thereof;
FIG. 5 is a top plan view thereof;
FIG. 6 is a bottom plan view thereof; and,
FIG. 7 is a perspective view thereof.

1 Claim, 4 Drawing Sheets

[56] **References Cited**

U.S. PATENT DOCUMENTS

D. 262,513	1/1982	Allen	D8/89
2,629,985	3/1953	McDowell	173/91
3,381,763	5/1968	Matson	173/91
3,529,497	9/1970	Brooks	173/91
4,043,020	8/1977	Hoggard	173/91
4,194,278	3/1980	Sanders	29/264
4,476,598	10/1984	Beauregard	7/170
4,633,562	1/1987	Ulsh	29/264

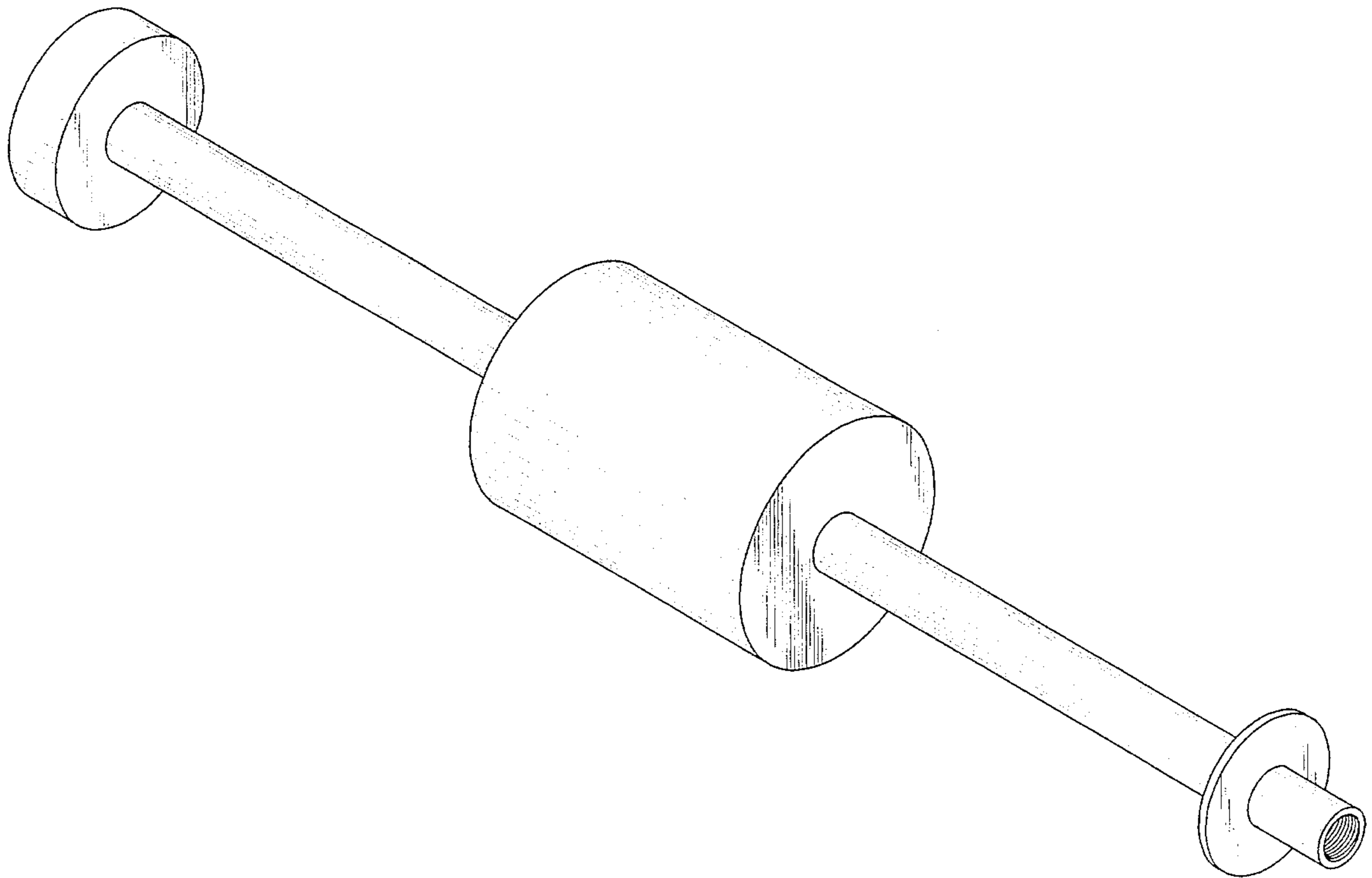

FIG. 1

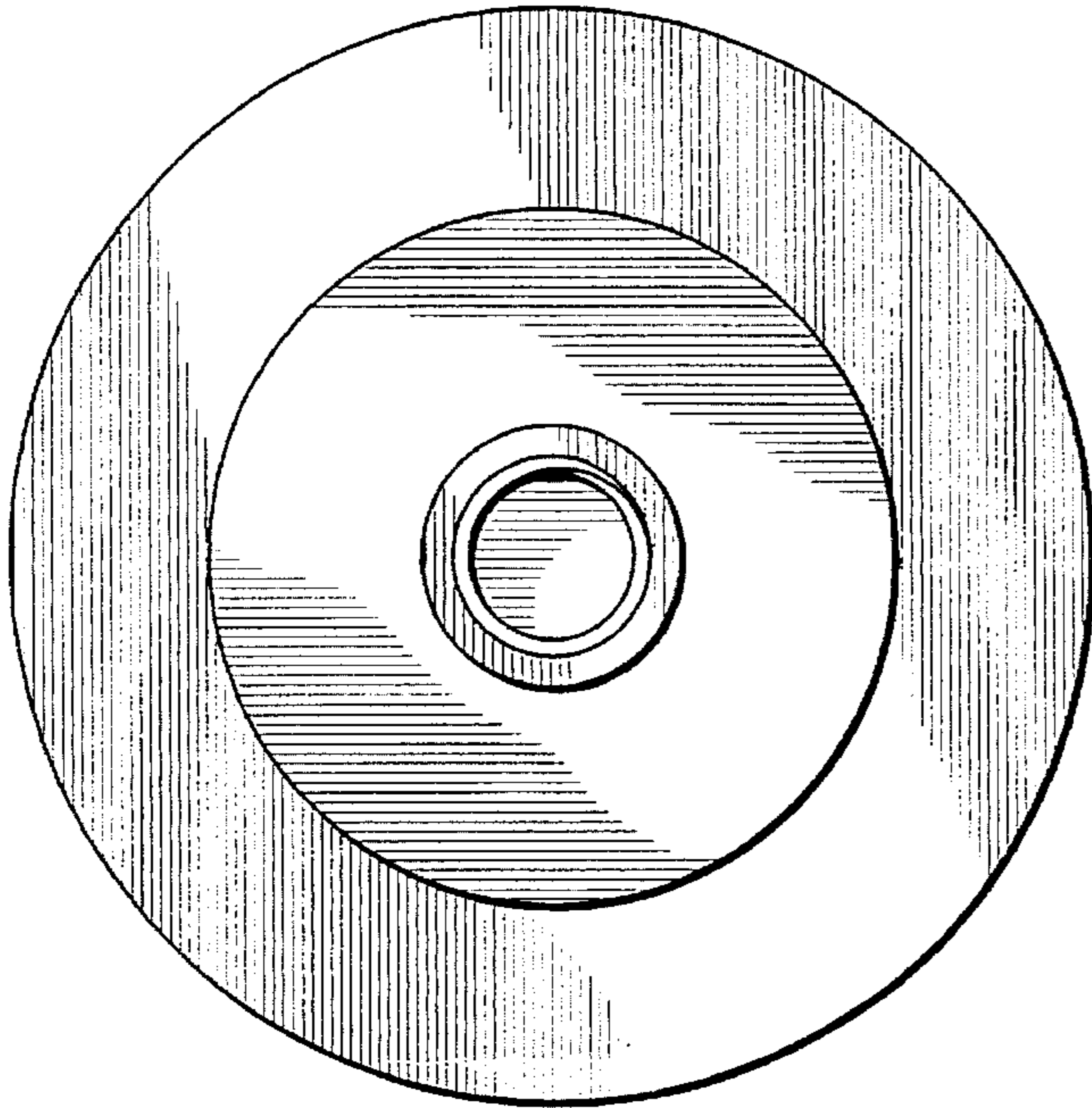

FIG. 2

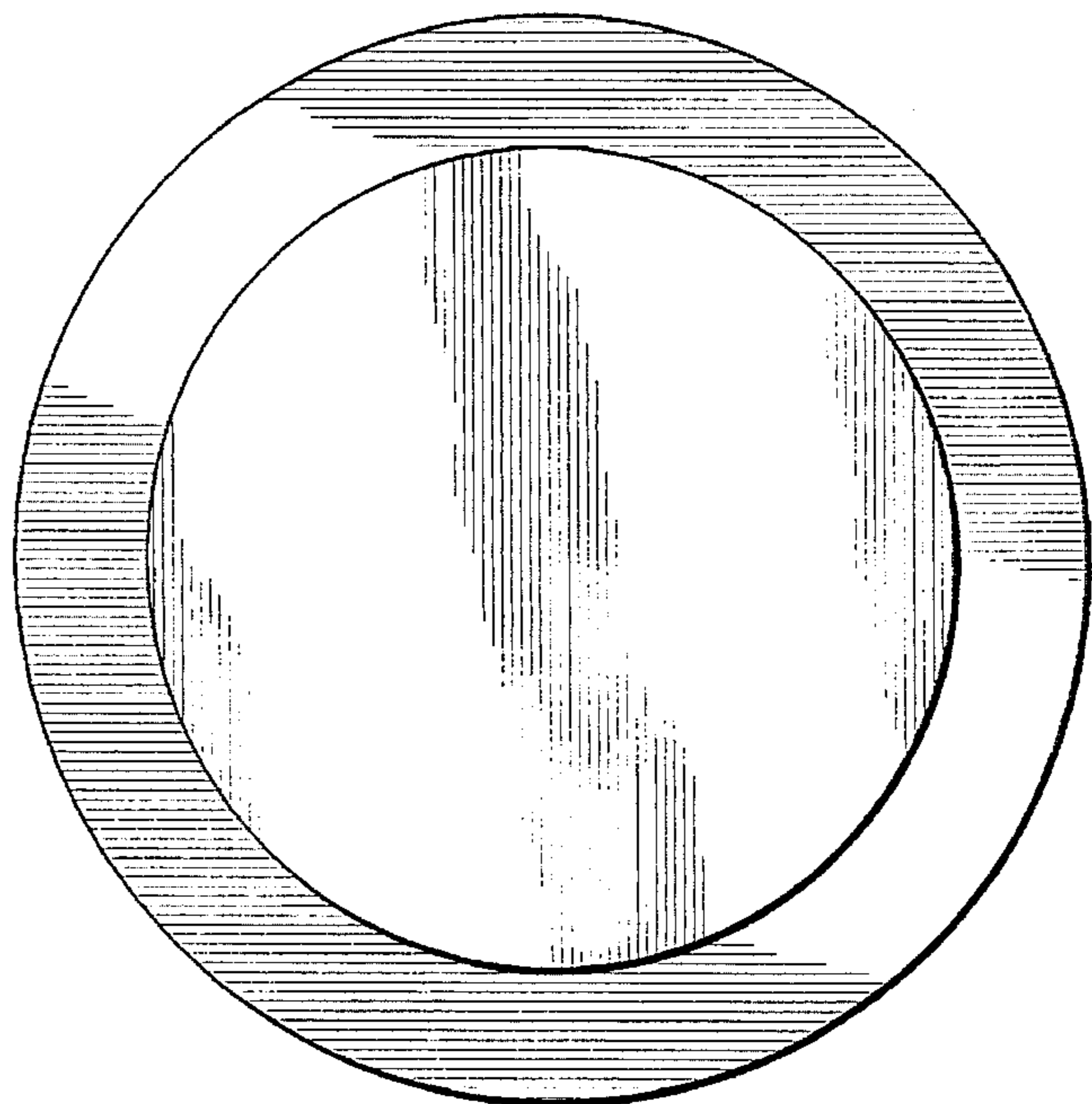

FIG. 3

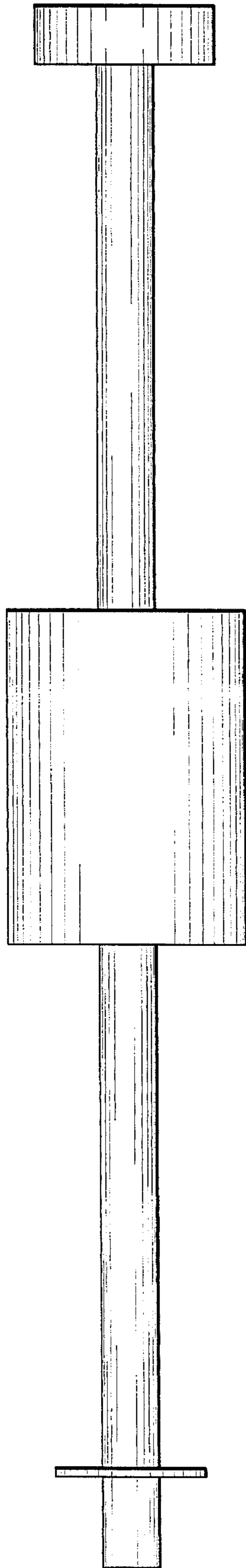

FIG. 4

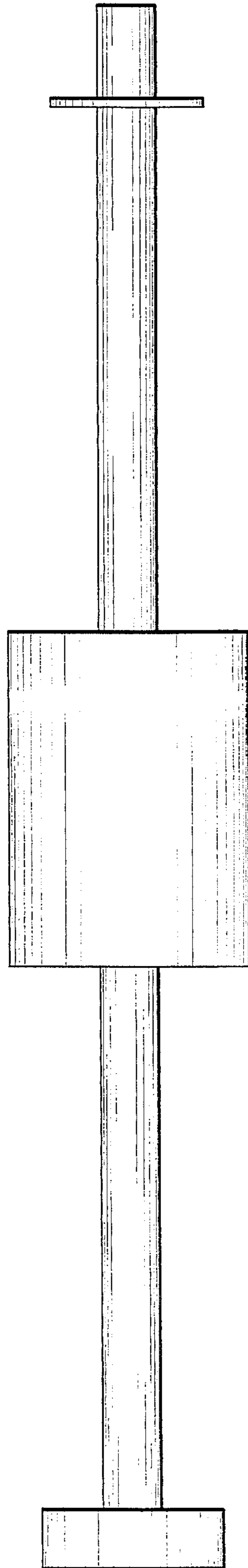

FIG. 5

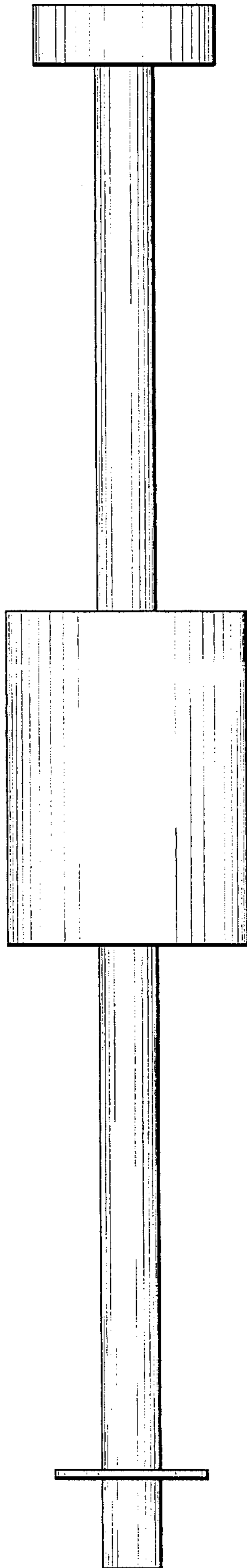

FIG. 6

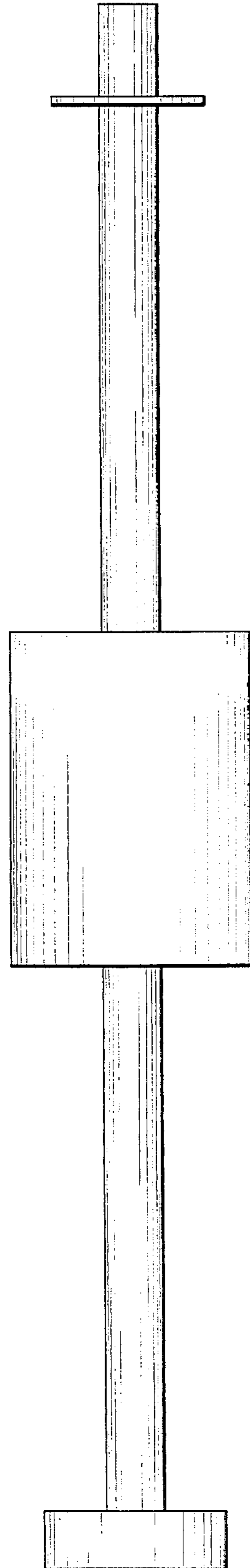

FIG. 7

