



US00D363181S

**United States Patent** [19]  
**Leviness**

[11] **Patent Number: Des. 363,181**  
[45] **Date of Patent: \*\*\* Oct. 17, 1995**

[54] **COFFEE FILTER DISPENSER**

[76] Inventor: **Robert W. Leviness**, P.I. Box 100,  
China, Tex. 77613

[\*] Notice: The portion of the term of this patent  
subsequent to Dec. 21, 2007 has been  
disclaimed.

[\*\*] Term: **14 Years**

[21] Appl. No.: **677,840**

[22] Filed: **Apr. 1, 1991**

[52] U.S. Cl. .... **D6/513; D7/601**

[58] **Field of Search** ..... D7/590, 601, 603,  
D7/609, 637, 629; D3/302; D6/515, 513,  
517, 536, 553, 567; 206/77.1, 207; 220/574;  
221/45, 282.6

[56] **References Cited**

**U.S. PATENT DOCUMENTS**

4,676,396 6/1987 Mamolou ..... 294/118 X

**OTHER PUBLICATIONS**

Filter Dispenser, Miles Kimball Company Catalog, p. 49.

*Primary Examiner*—Terry A. Wallace

[57] **CLAIM**

The ornamental design for a coffee filter dispenser, as shown  
and described.

**DESCRIPTION**

FIG. 1 is a front elevational view of the coffee filter  
dispenser showing my new design;  
FIG. 2 is a rear elevational view thereof;  
FIG. 3 is a left side elevational view thereof;  
FIG. 4 is a right side elevational view thereof;  
FIG. 5 is a top plan view thereof;  
FIG. 6 is a bottom plan view thereof; and,  
FIG. 7 is an exploded perspective view thereof.

**1 Claim, 4 Drawing Sheets**

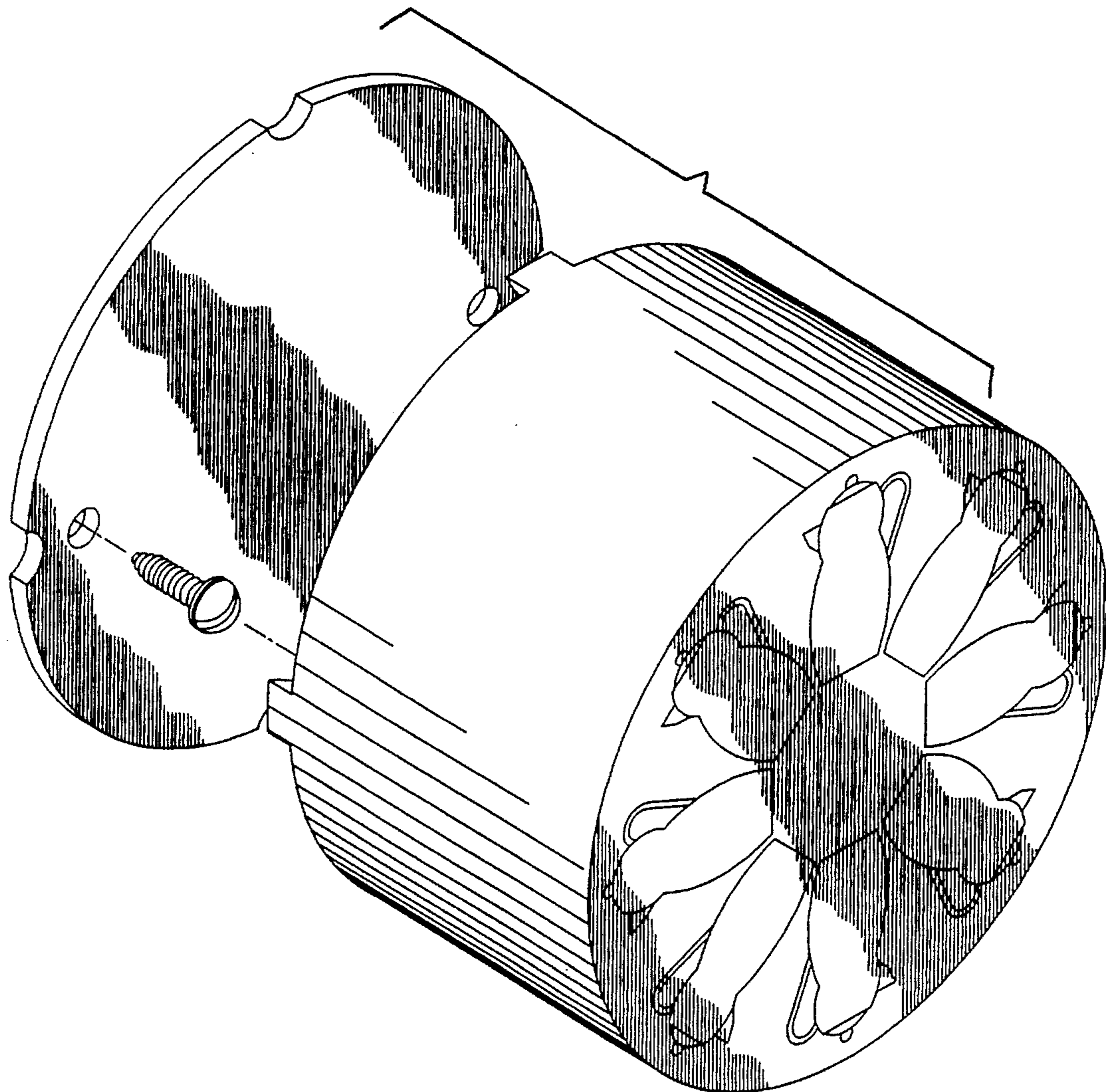

FIG. 1

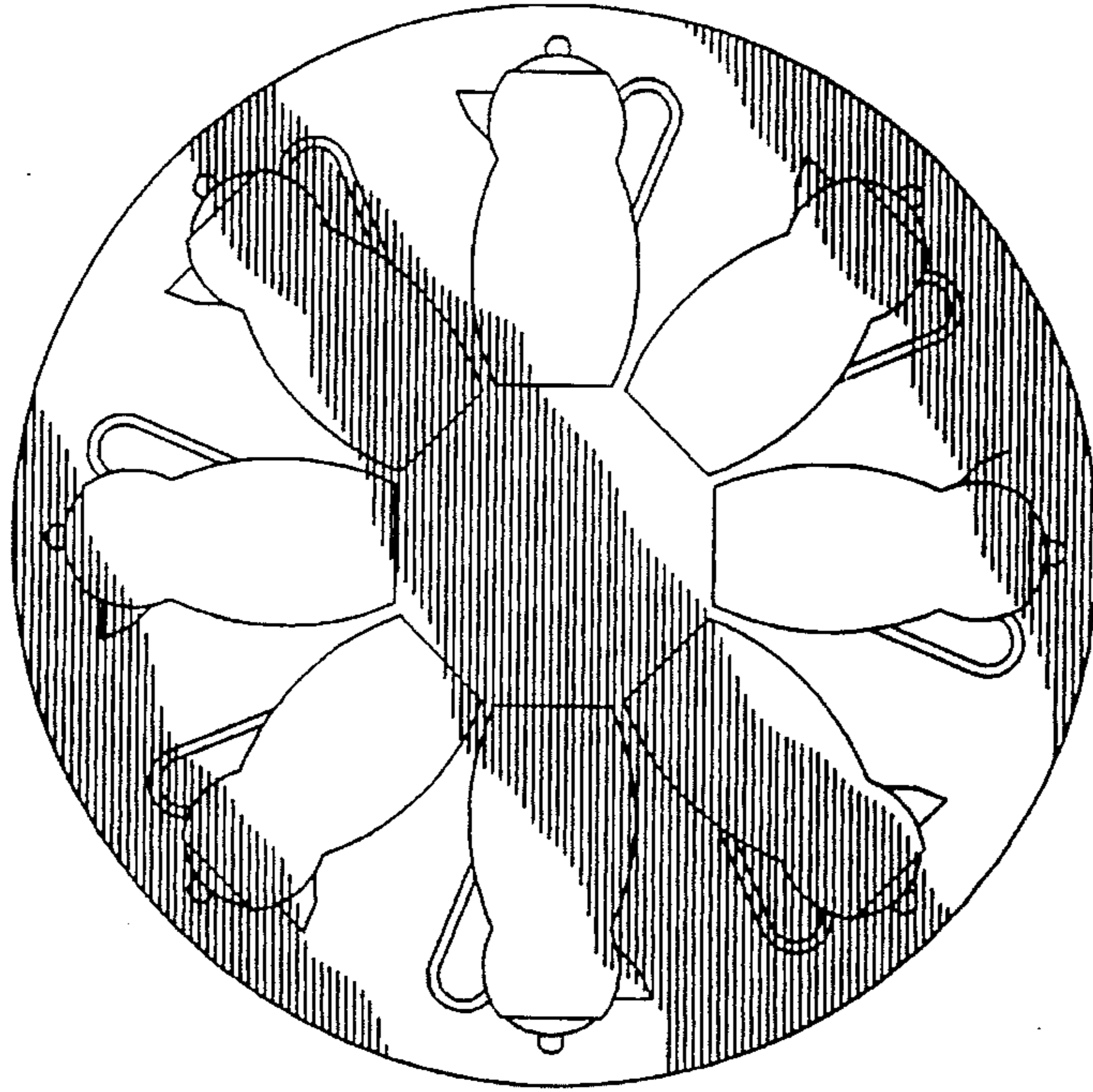

FIG. 2

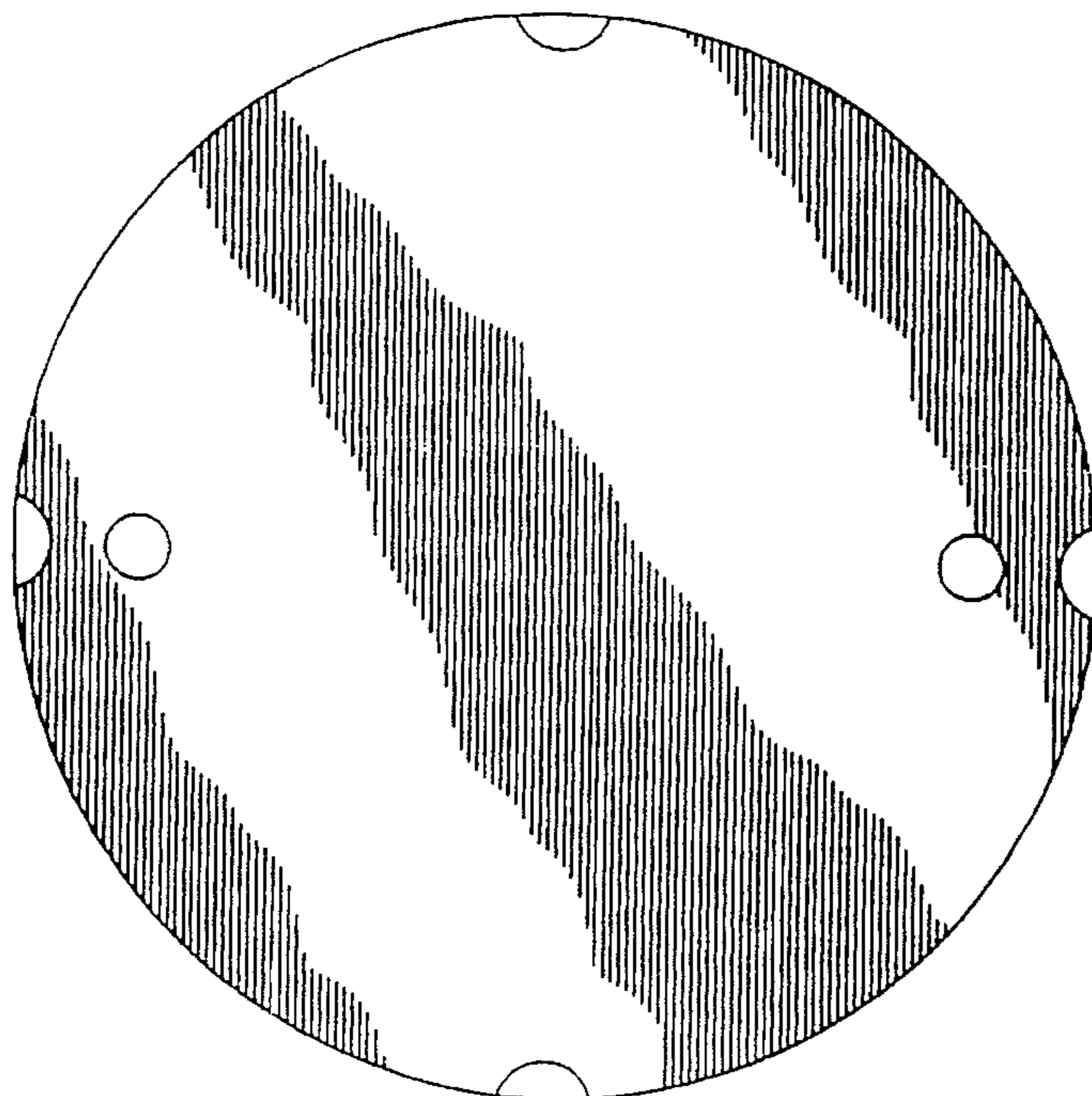

FIG. 3

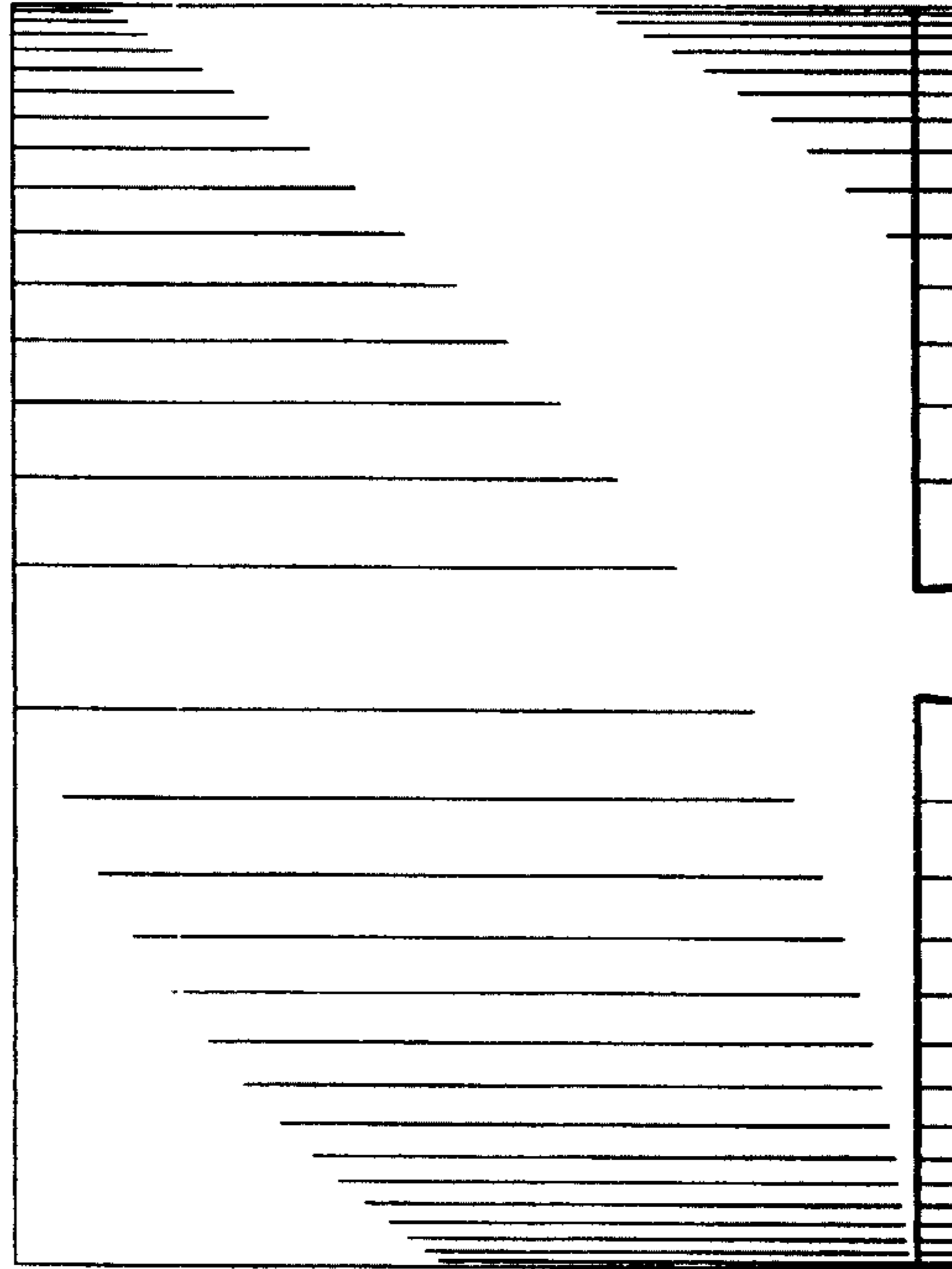

FIG. 4

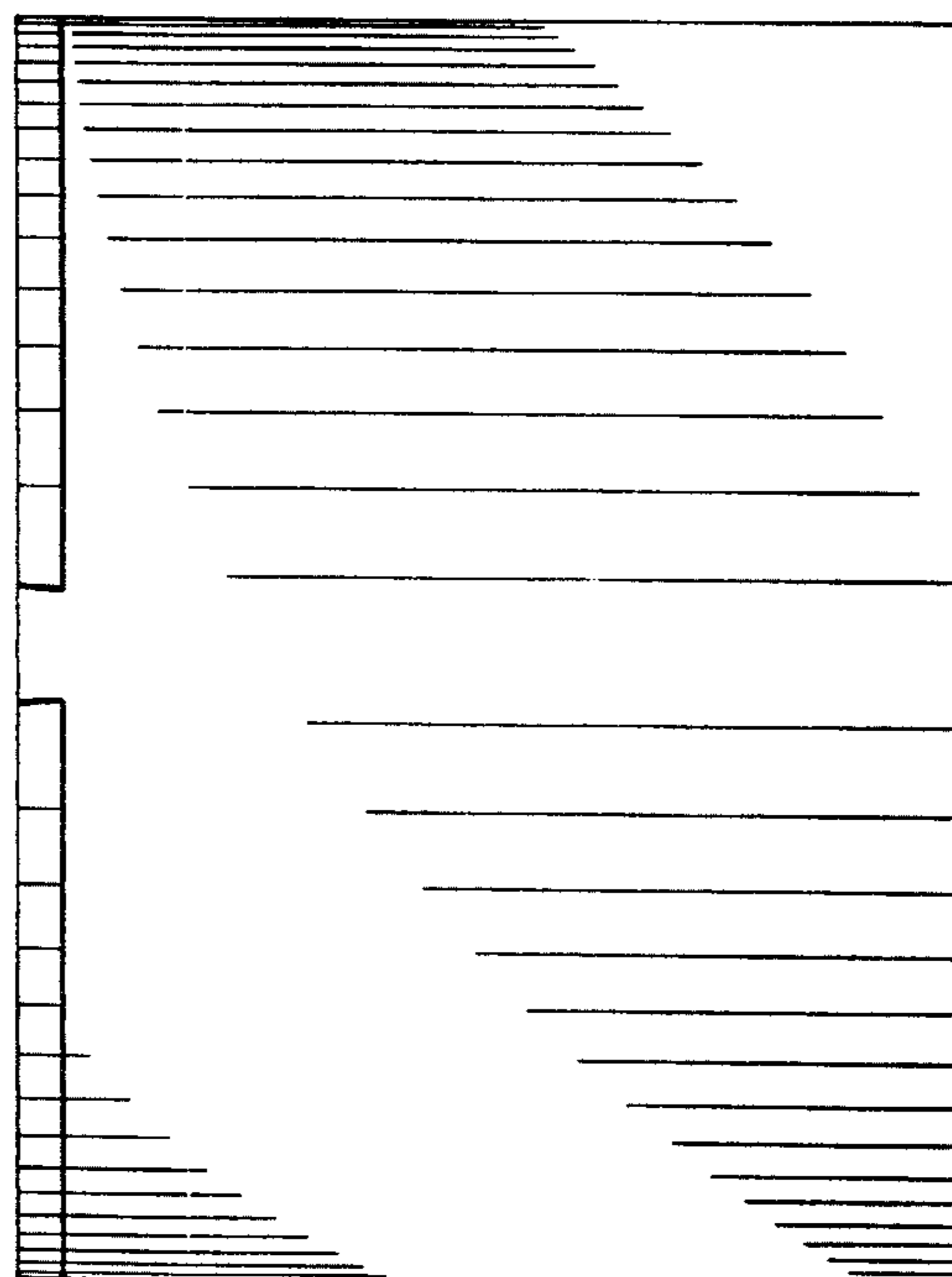

FIG. 5

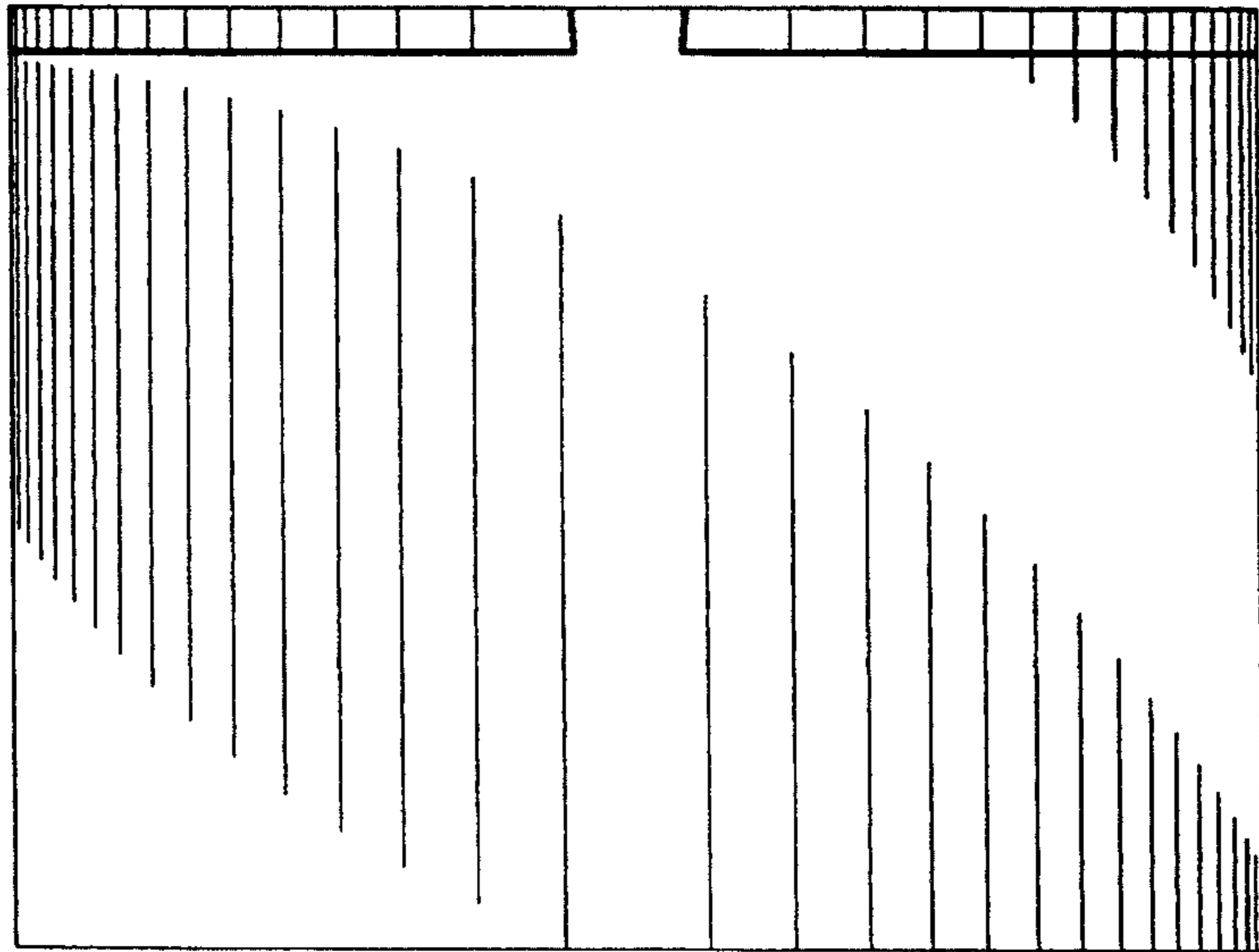

FIG. 6

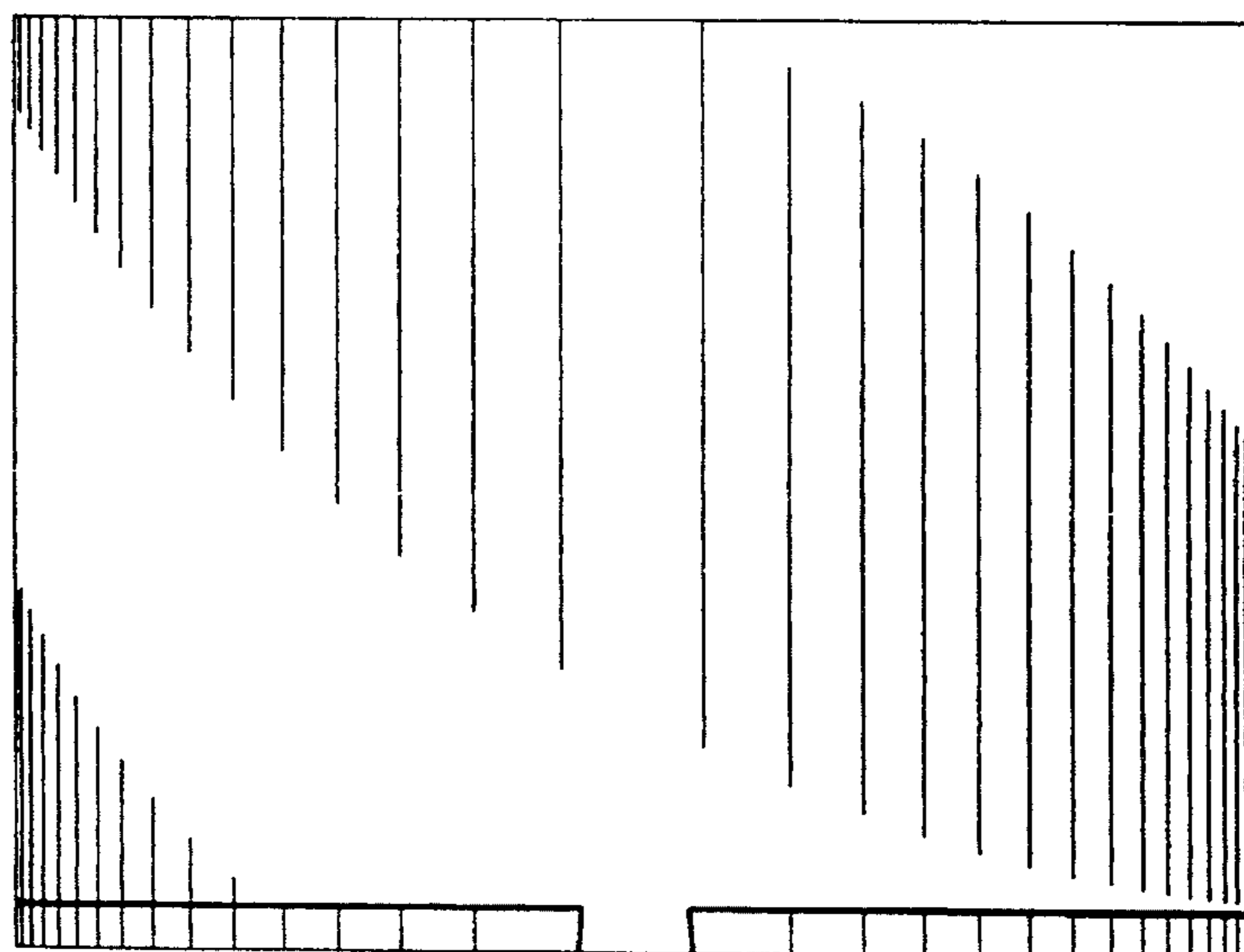



FIG. 7

