



US00D363172S

United States Patent [19]

[11] **Patent Number: Des. 363,172**

Warning

[45] **Date of Patent: **Oct. 17, 1995**

[54] **HAMMOCK**

2,382,528 8/1945 Anderegg 5/128

[76] Inventor: **Jeff J. Warning**, 405 South East St.,
Bloomfield, Iowa 52537

4,375,110 3/1983 Murphy .

5,016,301 5/1991 Combs .

5,170,521 12/1992 Light 5/122

[**] Term: **14 Years**

Primary Examiner—Janice E. Seeger

[21] Appl. No.: **20,125**

[57] CLAIM

[22] Filed: **Mar. 18, 1994**

The ornamental design for the hammock, as shown and described.

[52] U.S. Cl. **D6/387**

[58] Field of Search D6/386, 387; 5/120,
5/122, 123, 127, 128

DESCRIPTION

[56] References Cited

U.S. PATENT DOCUMENTS

D. 39,161	2/1908	Palmer	D6/387
D. 267,663	1/1983	Krisel	.	
D. 278,292	4/1985	Newby	.	
D. 287,077	12/1986	Hart	.	
842,698	1/1907	Pillman	5/123 X
972,783	10/1910	McBride	5/128
1,248,838	12/1917	Foster	5/122

FIG. 1 is a front elevational view of the hammock showing my new design;

FIG. 2 is a rear elevational view thereof;

FIG. 3 is a left side elevational view thereof;

FIG. 4 is a right side elevational view thereof;

FIG. 5 is a top plan view thereof;

FIG. 6 is a bottom plan view thereof; and,

FIG. 7 is a perspective view thereof.

1 Claim, 4 Drawing Sheets

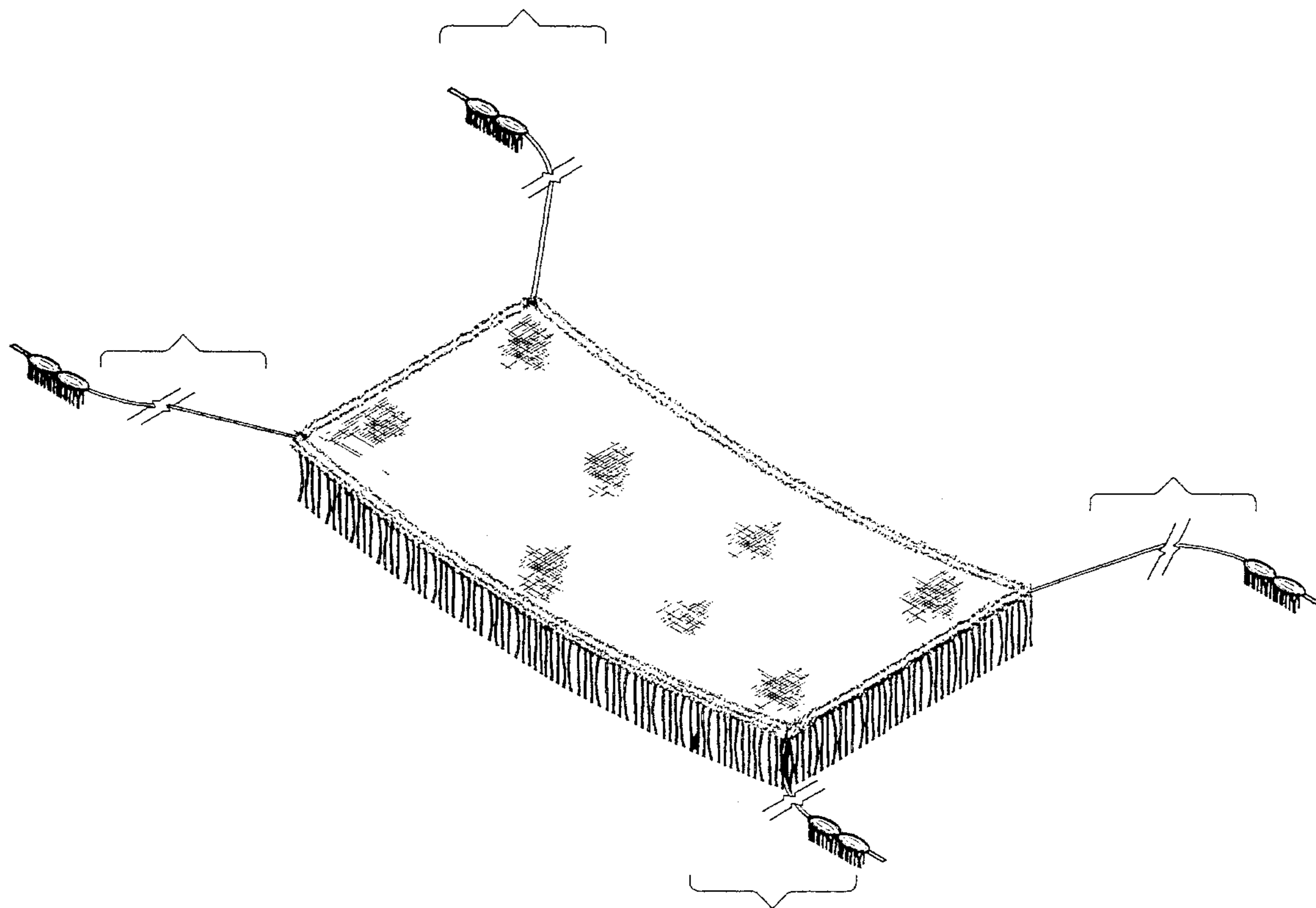

FIG. 1

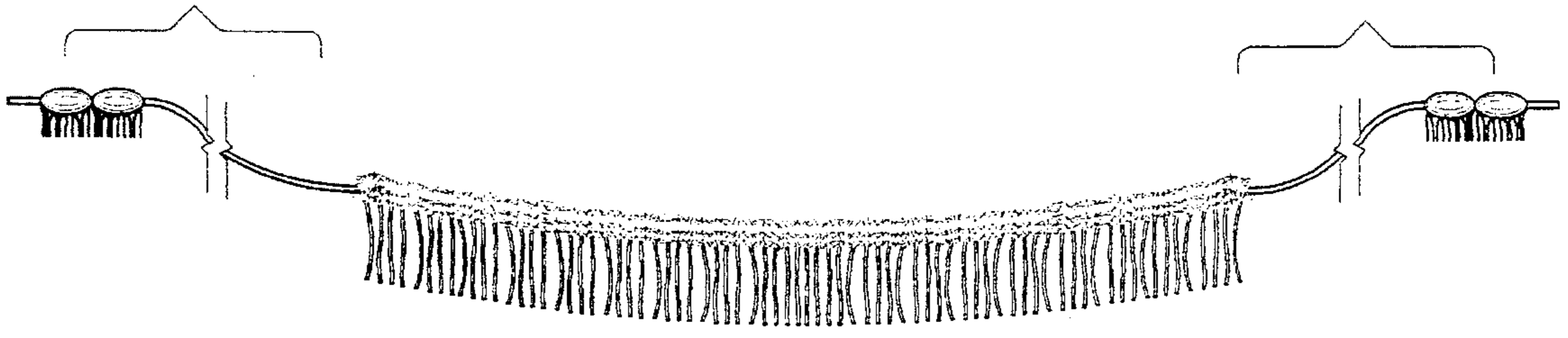

FIG. 2

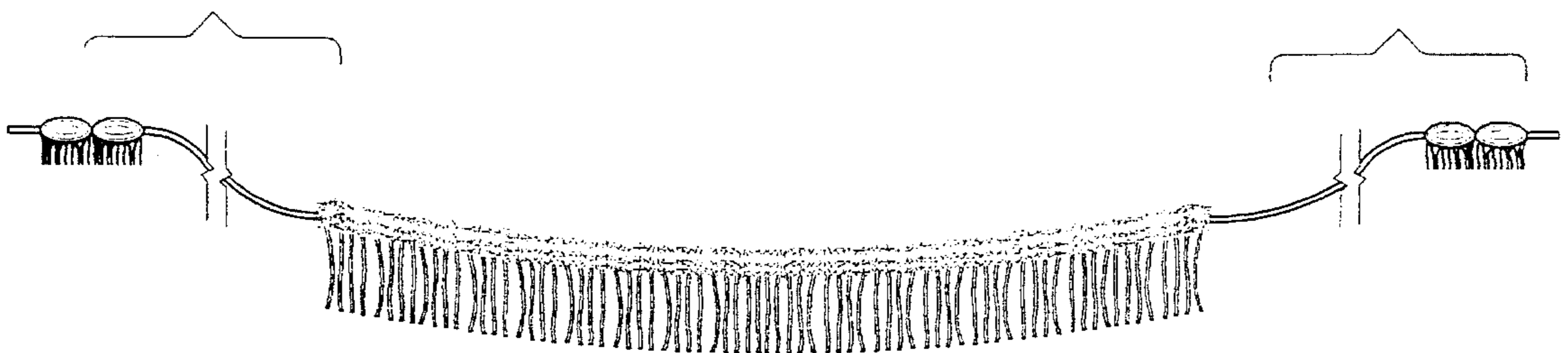

FIG. 3

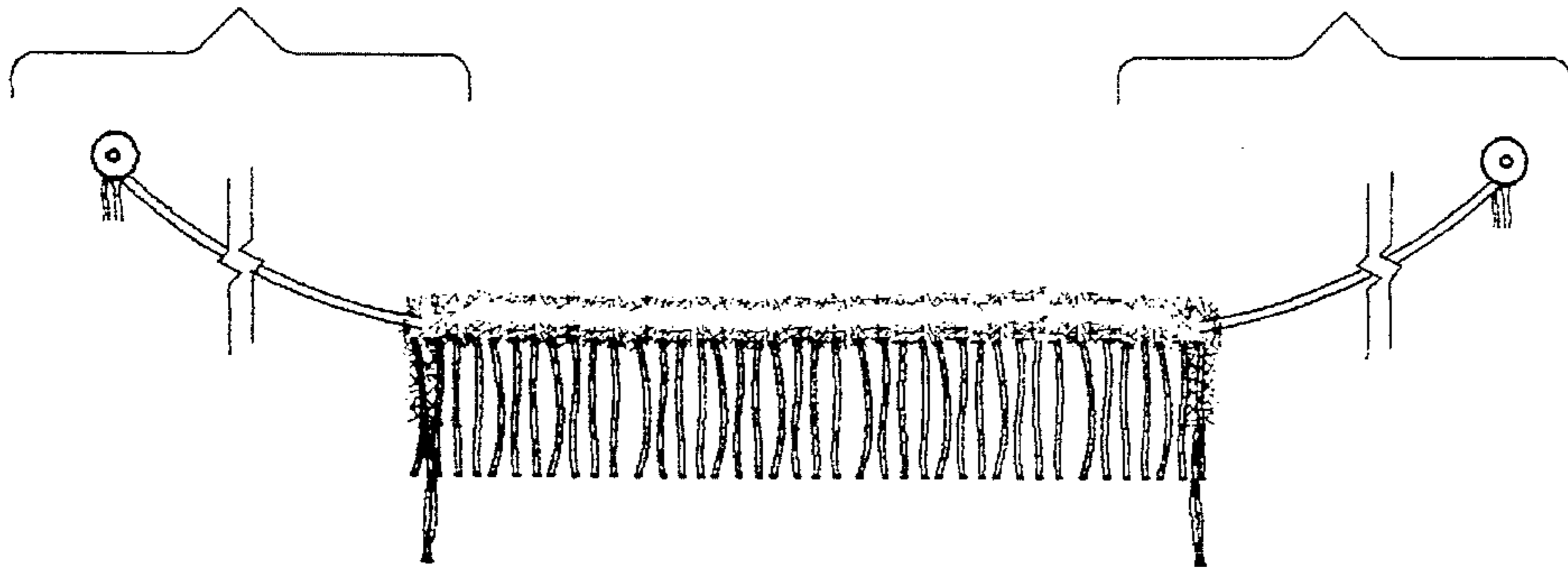
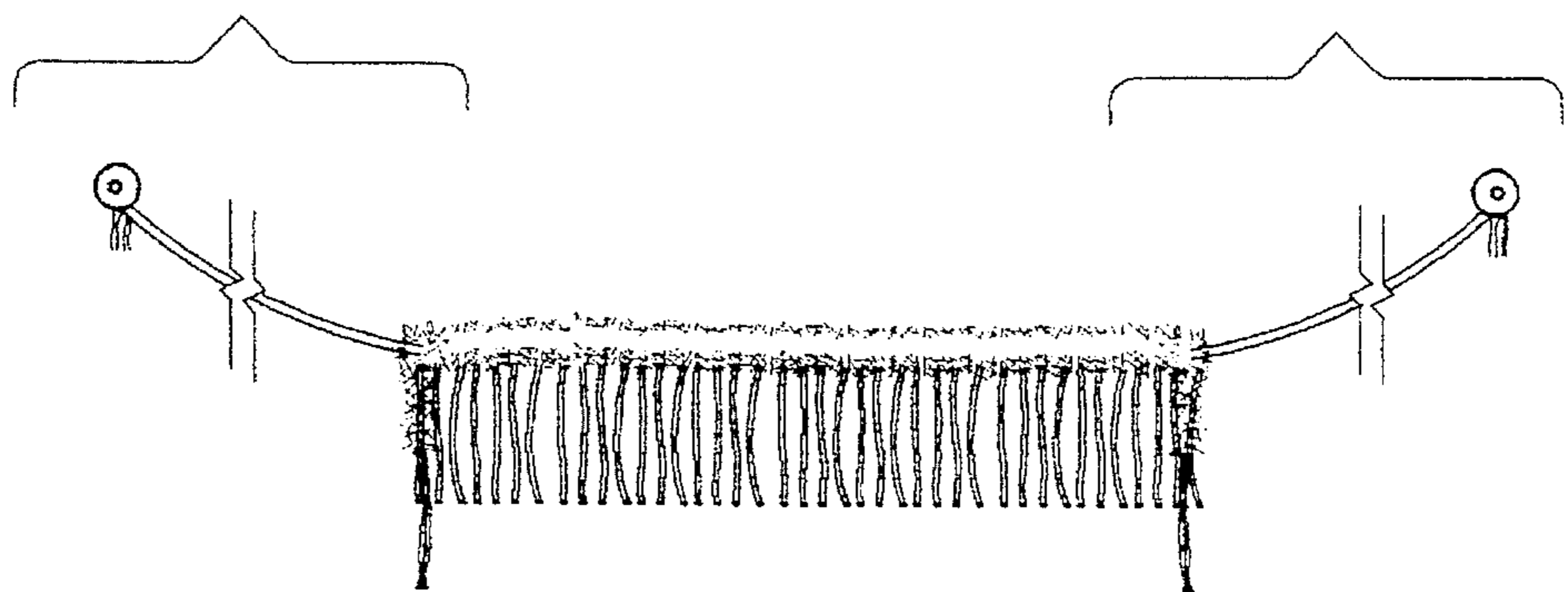

FIG. 4



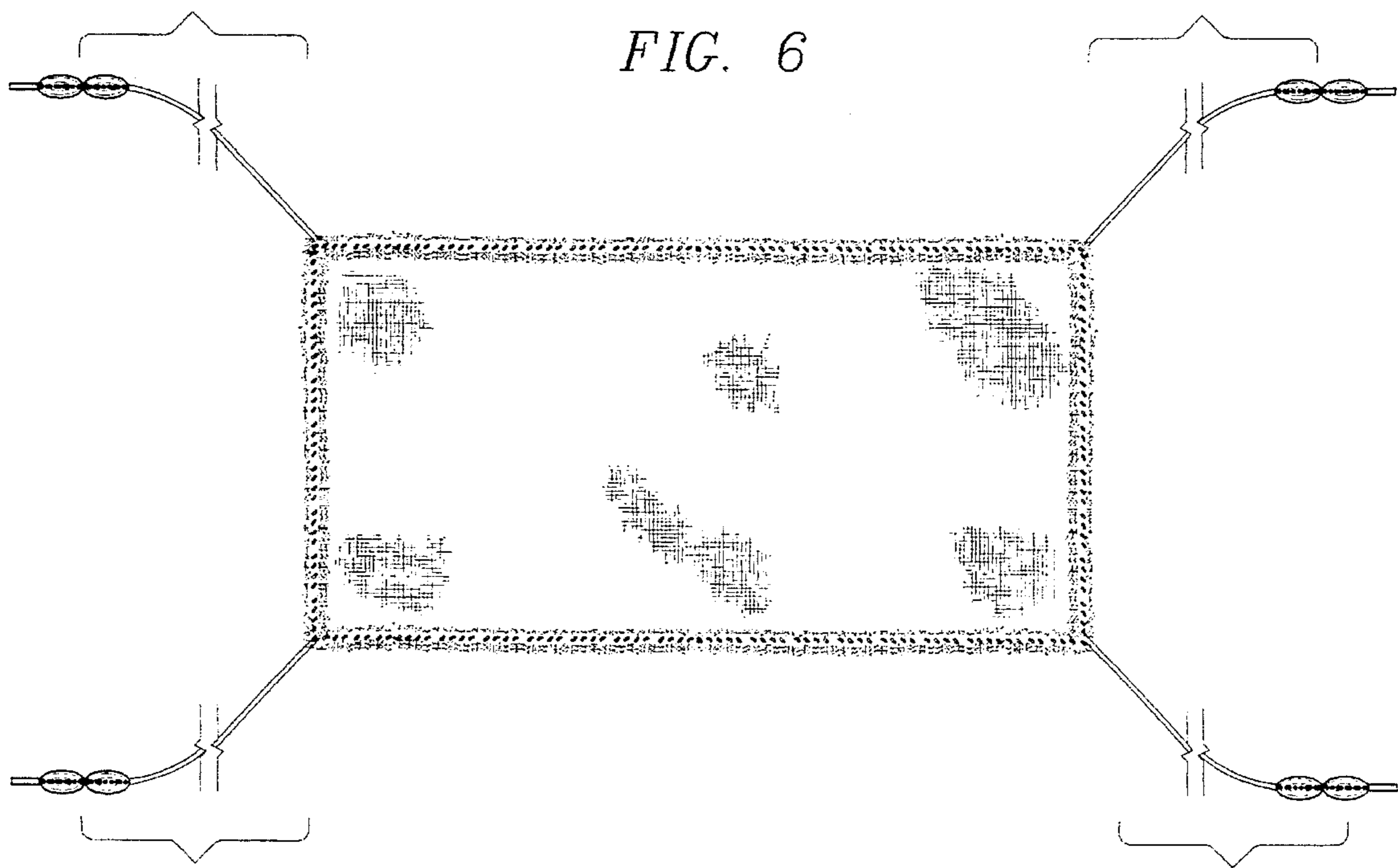
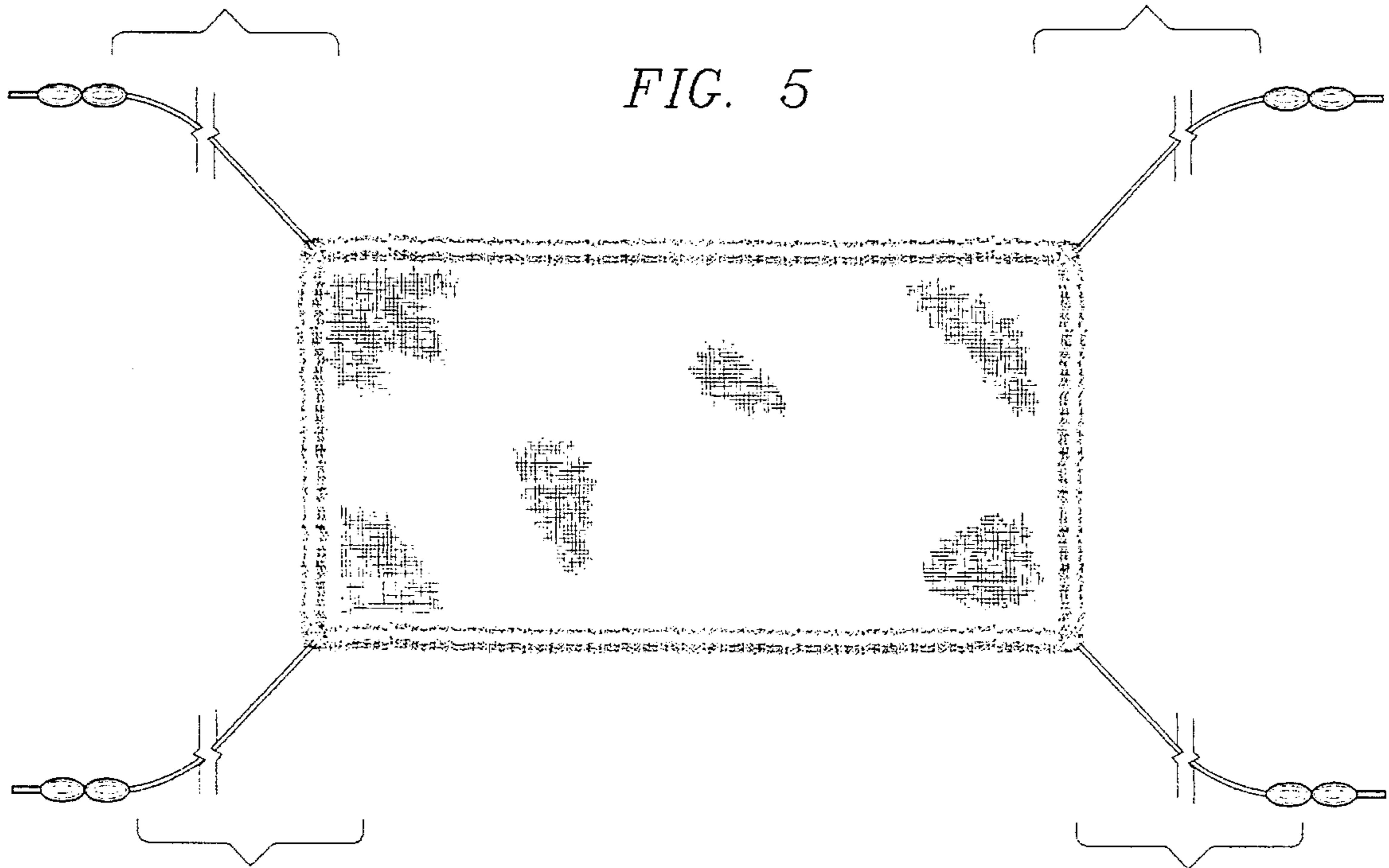

FIG. 7

