



US00D363138S

United States Patent [19]

[11] Patent Number: **Des. 363,138**

Poon

[45] Date of Patent: ****Oct. 10, 1995**

[54] RECHARGEABLE FLASHLIGHT

[75] Inventor: **Tit Y. Poon**, Chaiwan, Hong Kong

[73] Assignee: **Flying Dragon Development Ltd.**,
Hong Kong

[**] Term: **14 Years**

[21] Appl. No.: **20,857**

[22] Filed: **Apr. 4, 1994**

[52] U.S. Cl. **D26/46**

[58] Field of Search **D26/37-50; 362/157-158,**
362/171-172, 178, 181, 183, 192, 194,
196-197, 200-206

[56] References Cited

U.S. PATENT DOCUMENTS

D. 296,478	6/1988	Powell et al.	D26/49
D. 308,257	5/1990	Staubitz	D26/49
D. 332,321	1/1993	Yuen	D26/46

OTHER PUBLICATIONS

Rel 158-model, catalog page International Consumer Brands Inc, 1987.

Primary Examiner—A. Hugo Word

Assistant Examiner—Robin V. Taylor
Attorney, Agent, or Firm—Samuels, Gauthier & Stevens

[57] CLAIM

The ornamental design for a rechargeable flashlight, as shown and described.

DESCRIPTION

FIG. 1 is a perspective view of a rechargeable flashlight showing my new design;

FIG. 2 is a perspective view with plug extended thereof;

FIG. 3 is a top plan view thereof;

FIG. 4 is a side view thereof, the other side being a mirror image;

FIG. 5 is a bottom plan view thereof;

FIG. 6 is a front elevational view thereof; and,

FIG. 7 is a rear elevation view thereof.

1 Claim, 7 Drawing Sheets

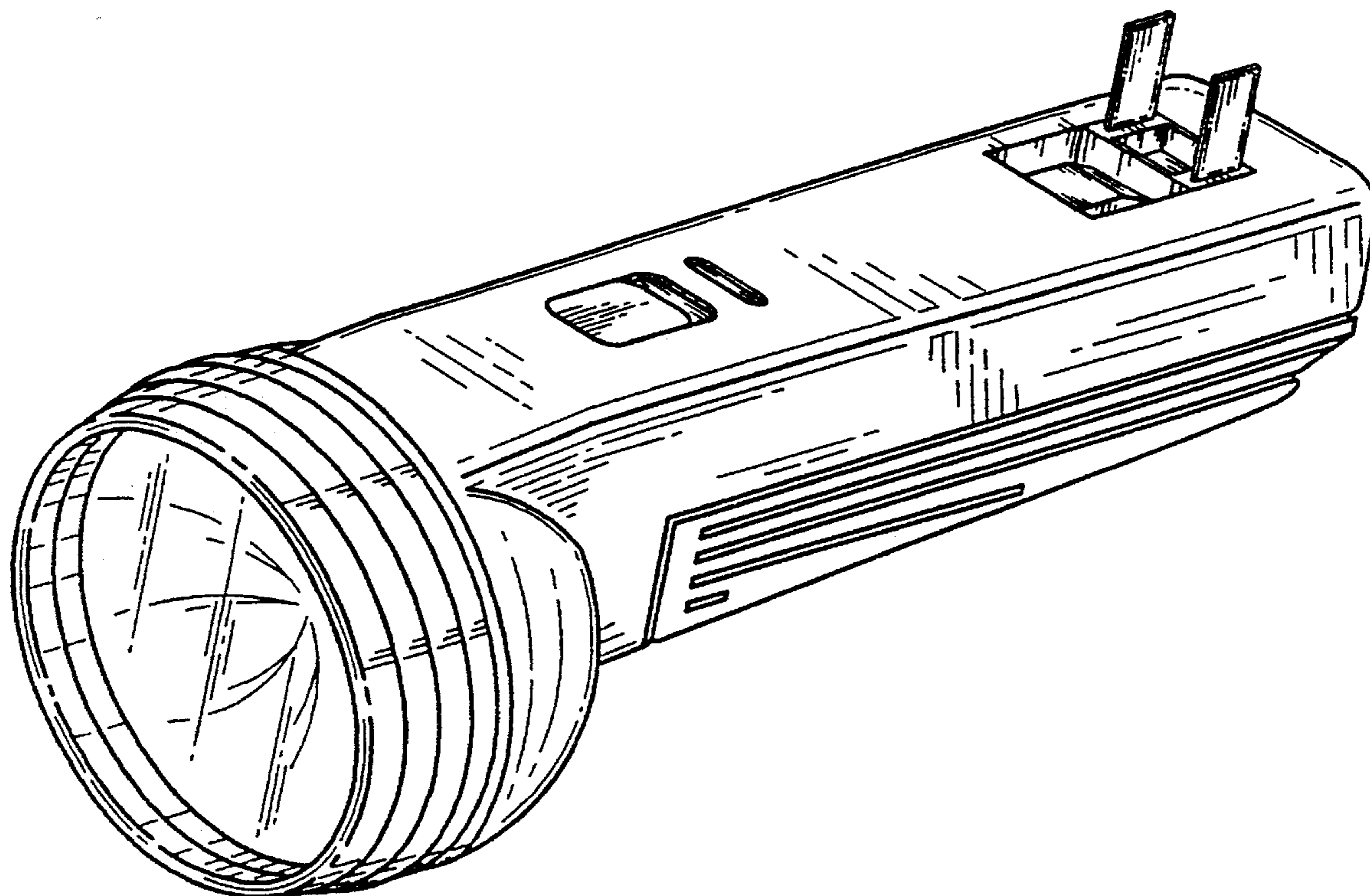
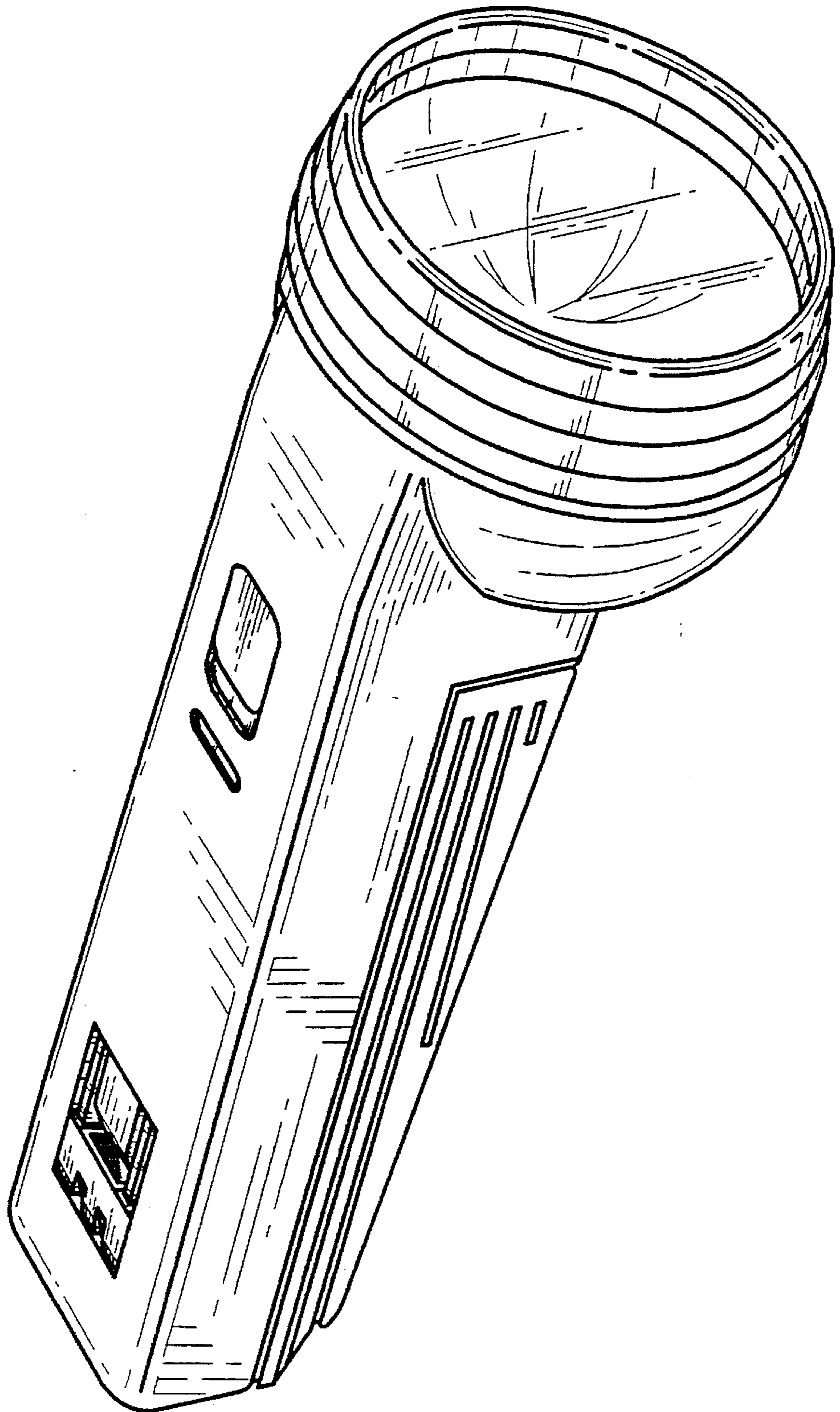

Fig. 1



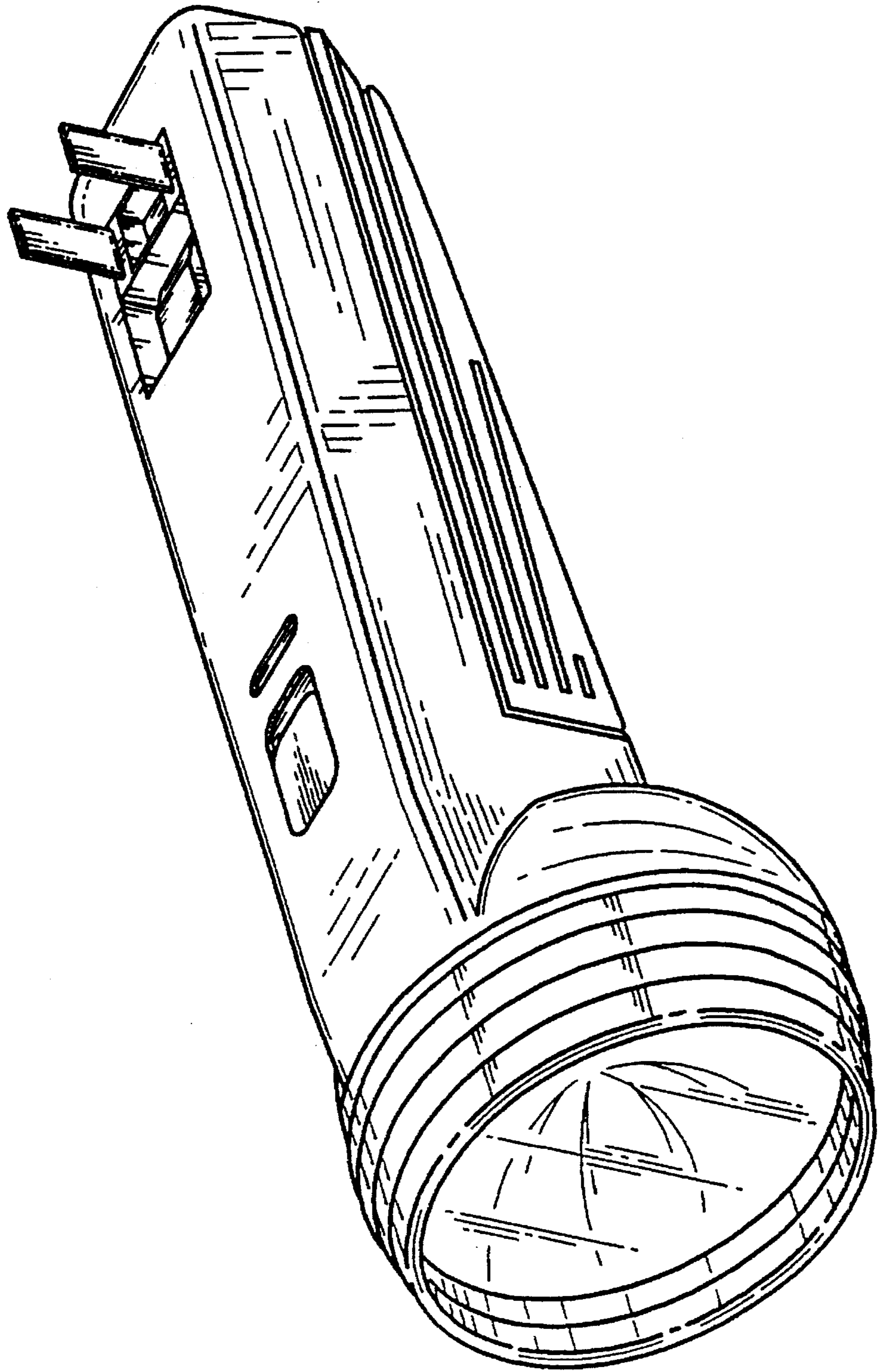

Fig. 2

Fig. 3

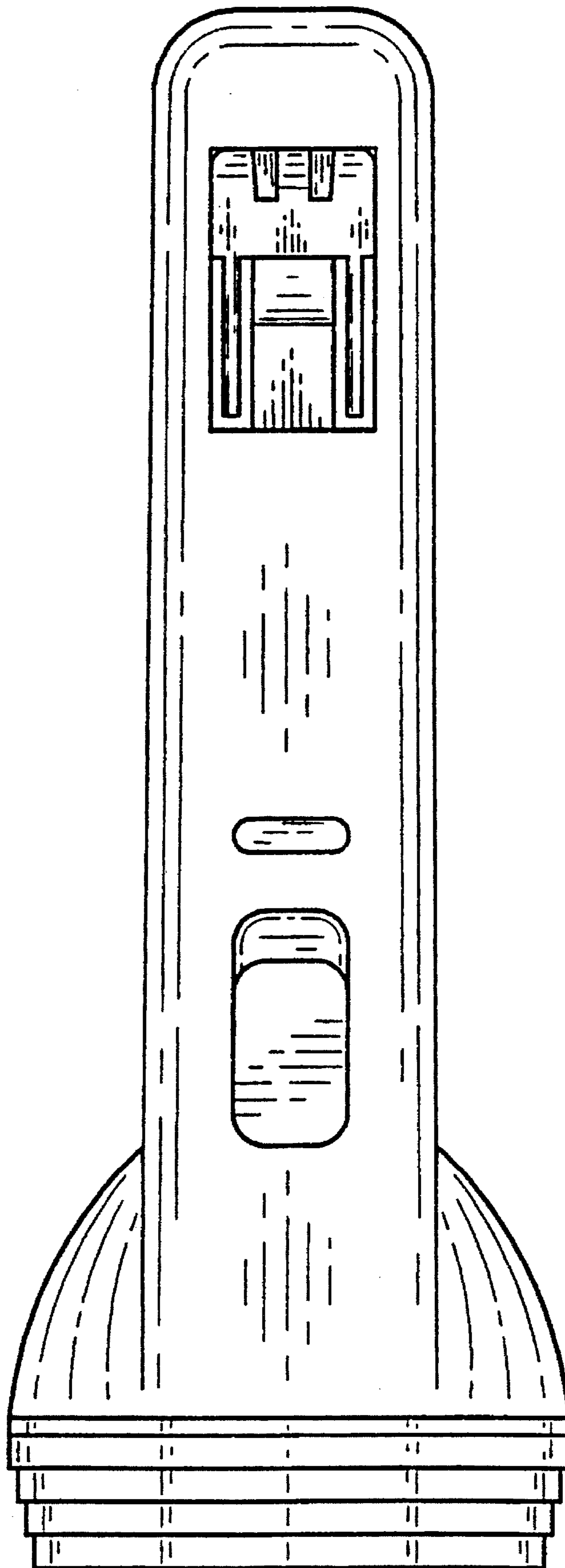

Fig. 4

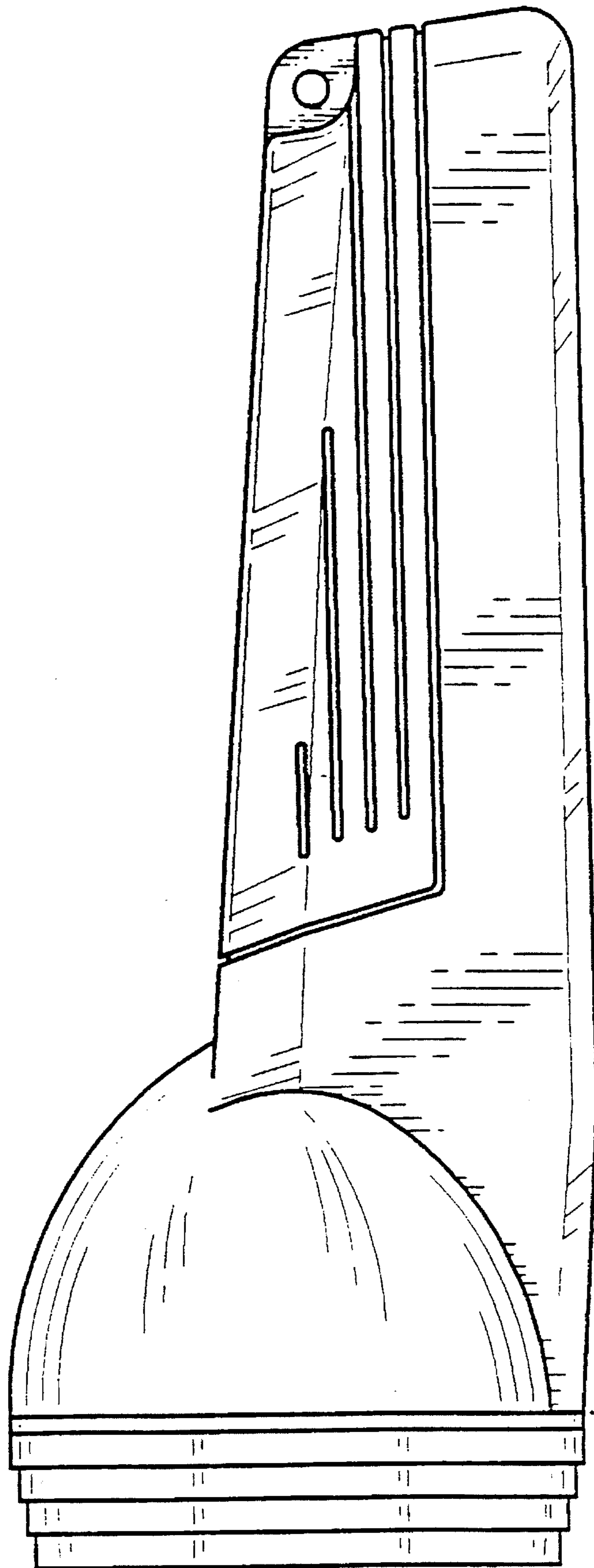

Fig. 5

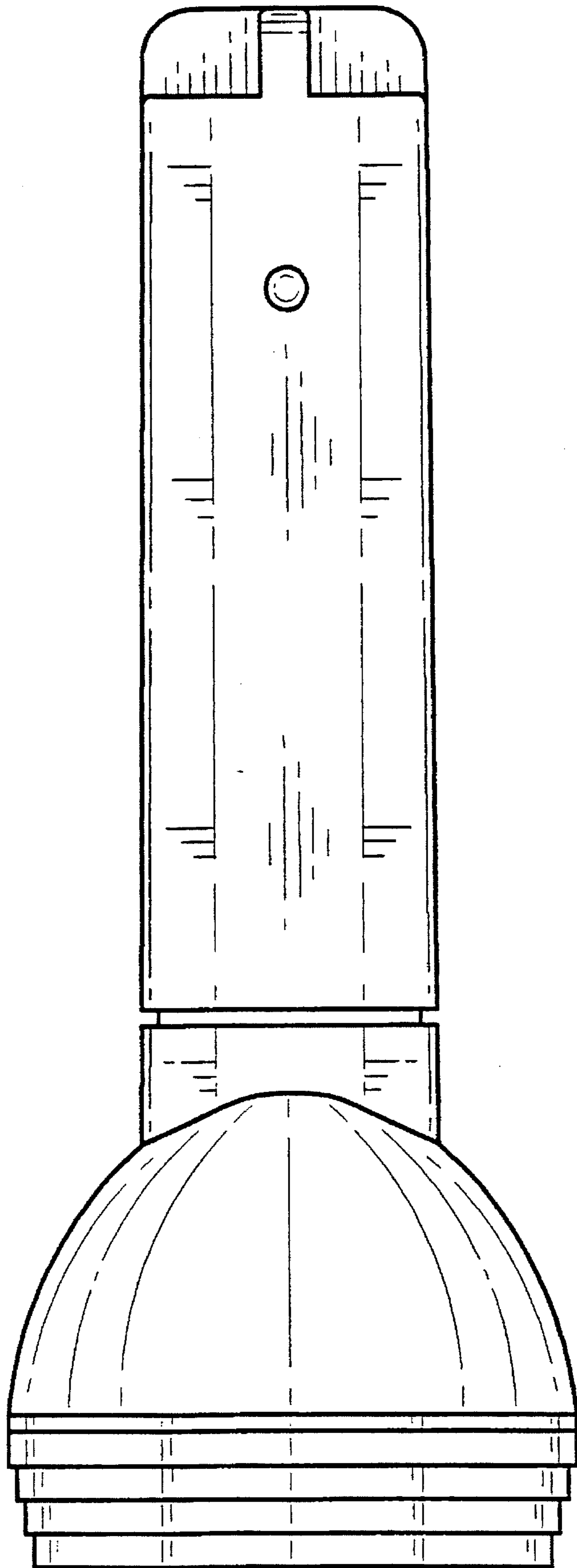

Fig. 6

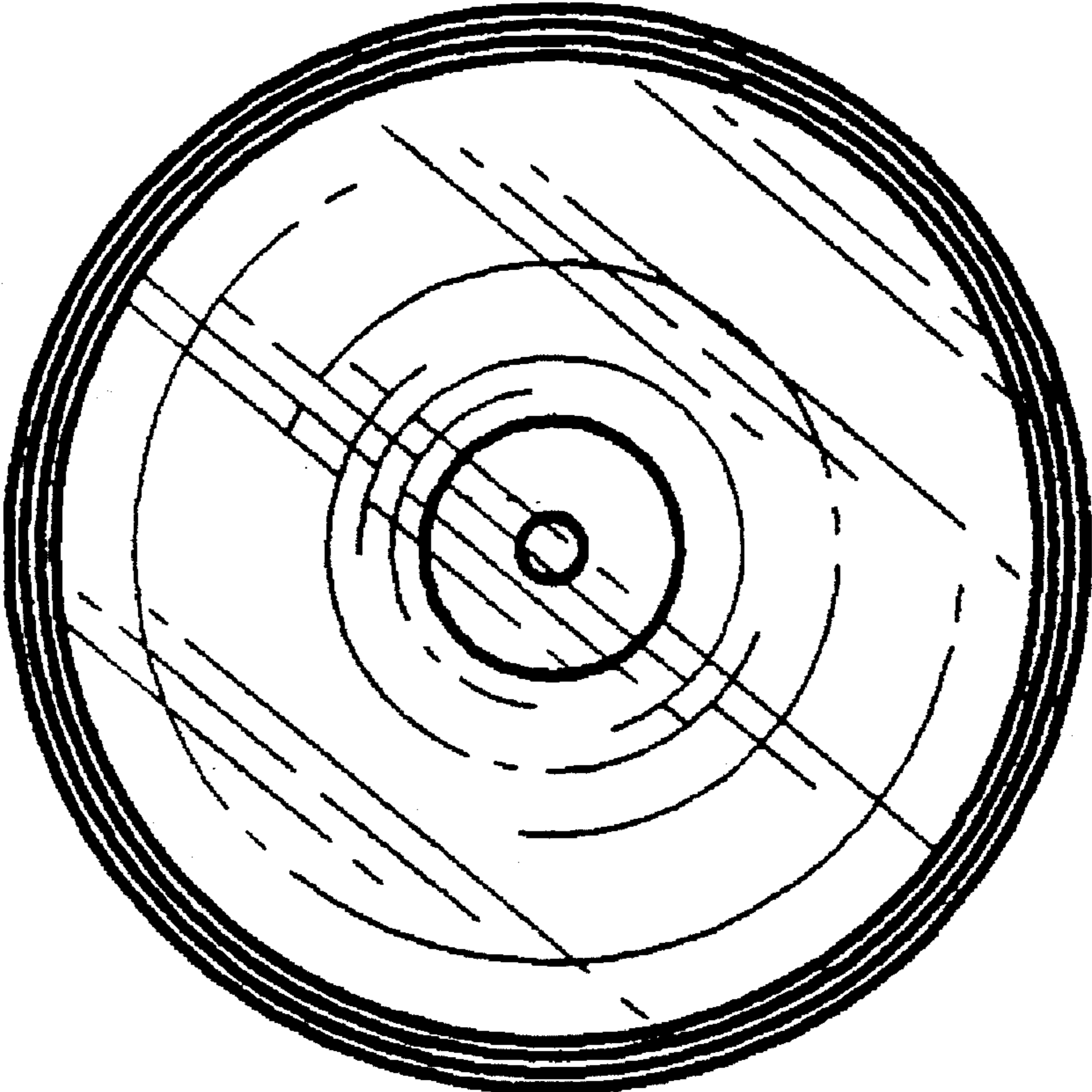

Fig. 7

