



US00D362971S

United States Patent [19]

[11] Patent Number: **Des. 362,971**

Pacheco

[45] Date of Patent: ****Oct. 10, 1995**

[54] **HIGH CHAIR**

4,235,474 11/1980 Rosenberg .
4,540,218 9/1985 Thomas .
4,676,554 6/1987 Harlick et al. .
4,697,849 10/1987 Smith .

[76] Inventor: **Debra A. Pacheco**, 3917-8th St.,
Baltimore, Md. 21225

[**] Term: **14 Years**

Primary Examiner—Janice E. Seeger

[21] Appl. No.: **16,034**

[57] **CLAIM**

[22] Filed: **Dec. 6, 1993**

The ornamental design for the high chair, as shown and described.

[52] U.S. Cl. **D6/339**

[58] Field of Search D6/333, 334, 335,
D6/338, 339, 367; 297/148-150, 487, 488,
467, 250.1, 253, 254, 255

DESCRIPTION

[56] **References Cited**

U.S. PATENT DOCUMENTS

D. 248,516 7/1978 Johansson D6/335
D. 263,775 4/1982 Hopper D6/339
2,574,289 11/1951 Rossi 297/149 X
3,325,213 6/1967 Levy 297/250.1 X
3,713,692 1/1973 McCracken et al. .

FIG. 1 is a front elevational view of the high chair showing my new design;
FIG. 2 is a rear elevational view thereof;
FIG. 3 is a left side elevational view thereof;
FIG. 4 is a right side elevational view thereof;
FIG. 5 is a top plan view thereof;
FIG. 6 is a bottom plan view thereof; and,
FIG. 7 is a perspective view thereof.

1 Claim, 4 Drawing Sheets

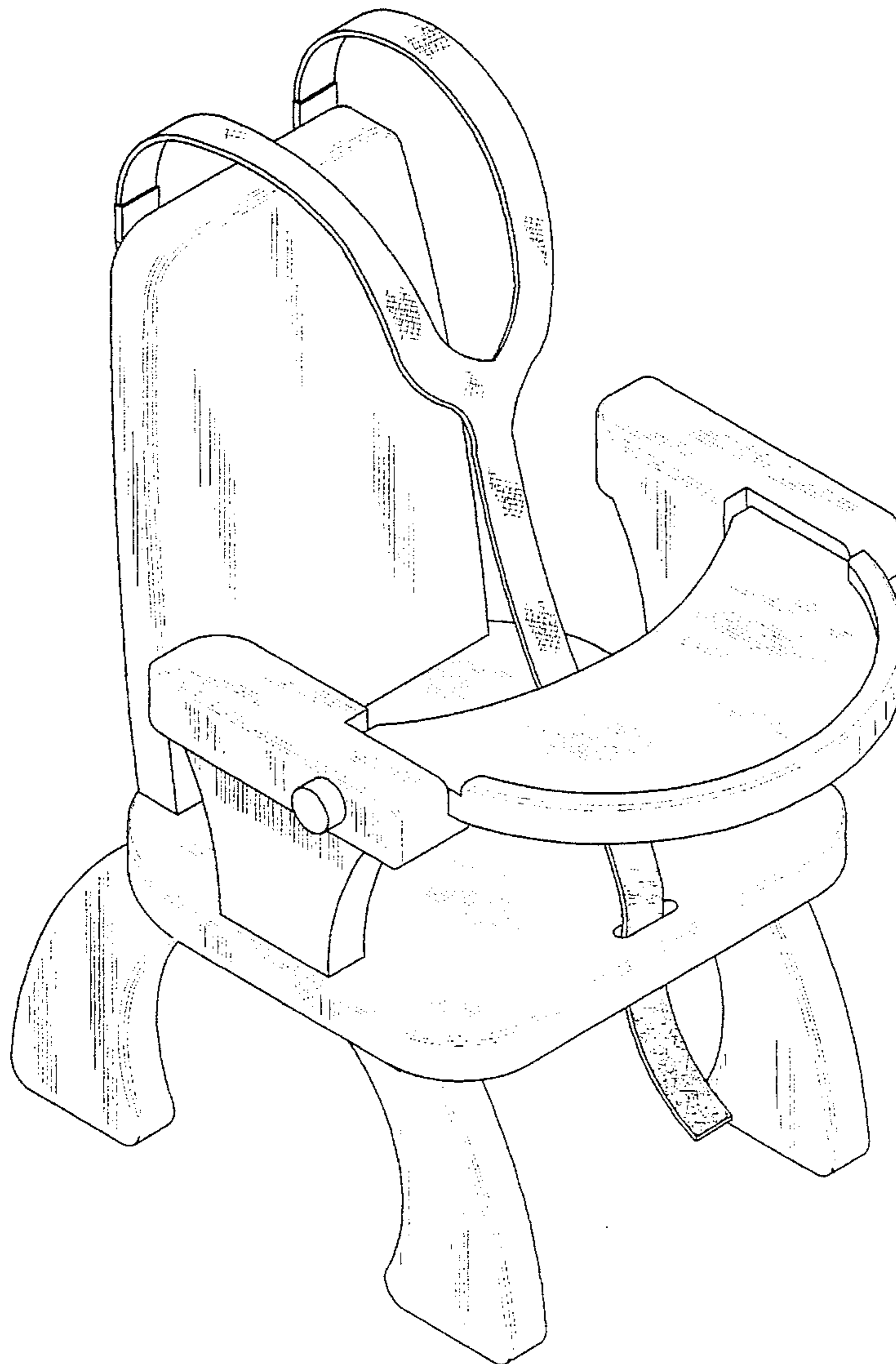

FIG. 1

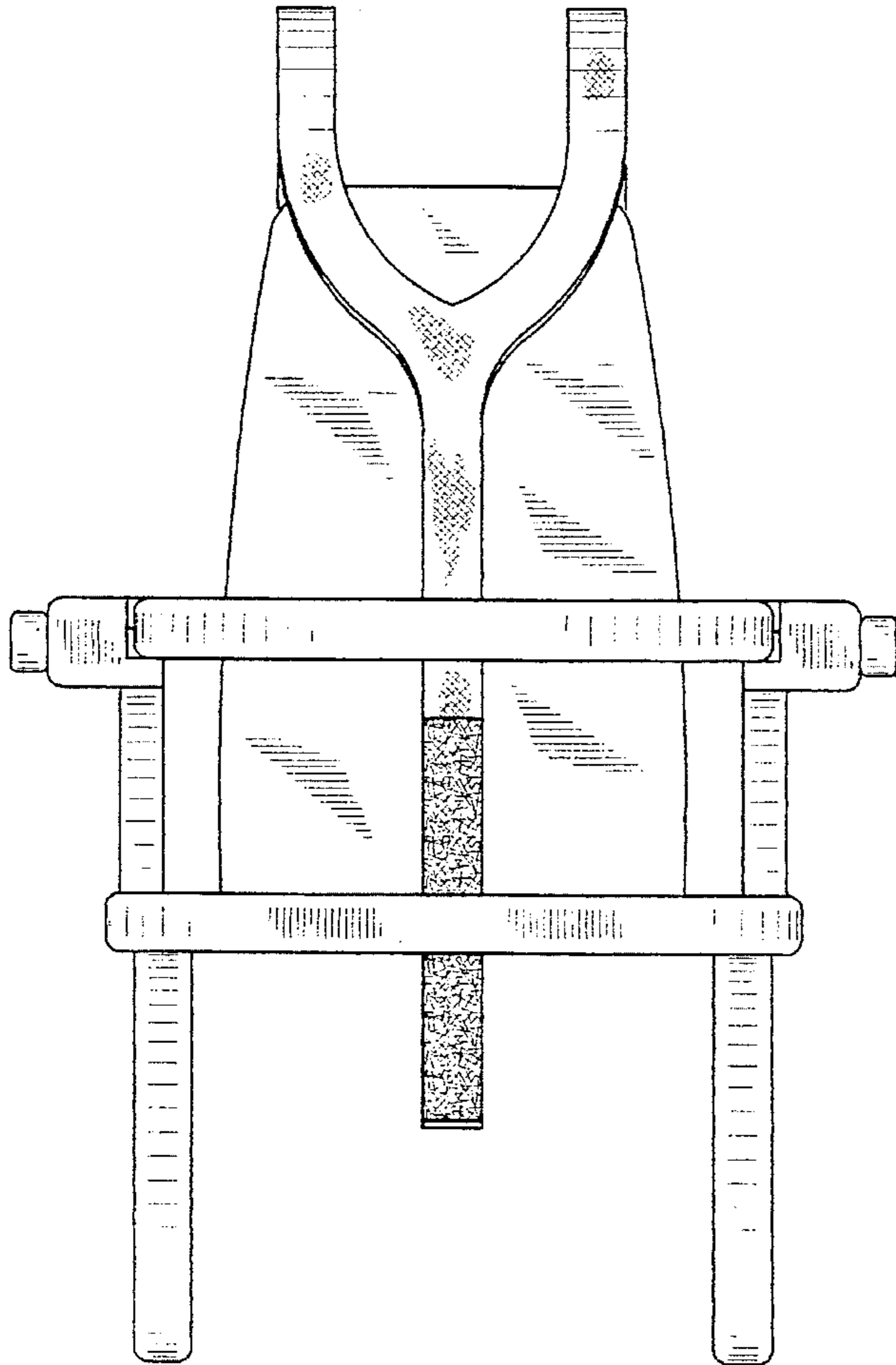

FIG. 2

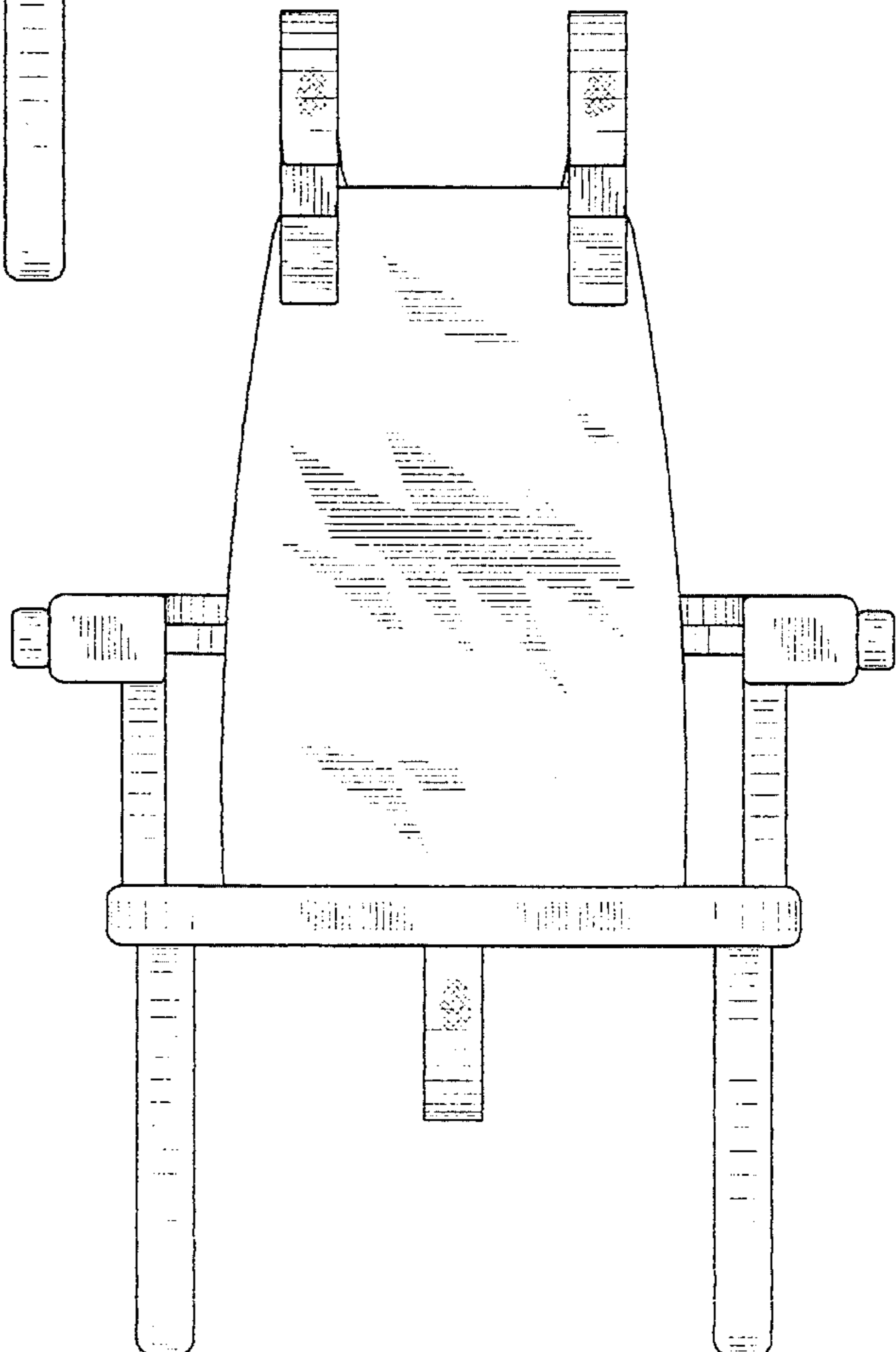

FIG. 3

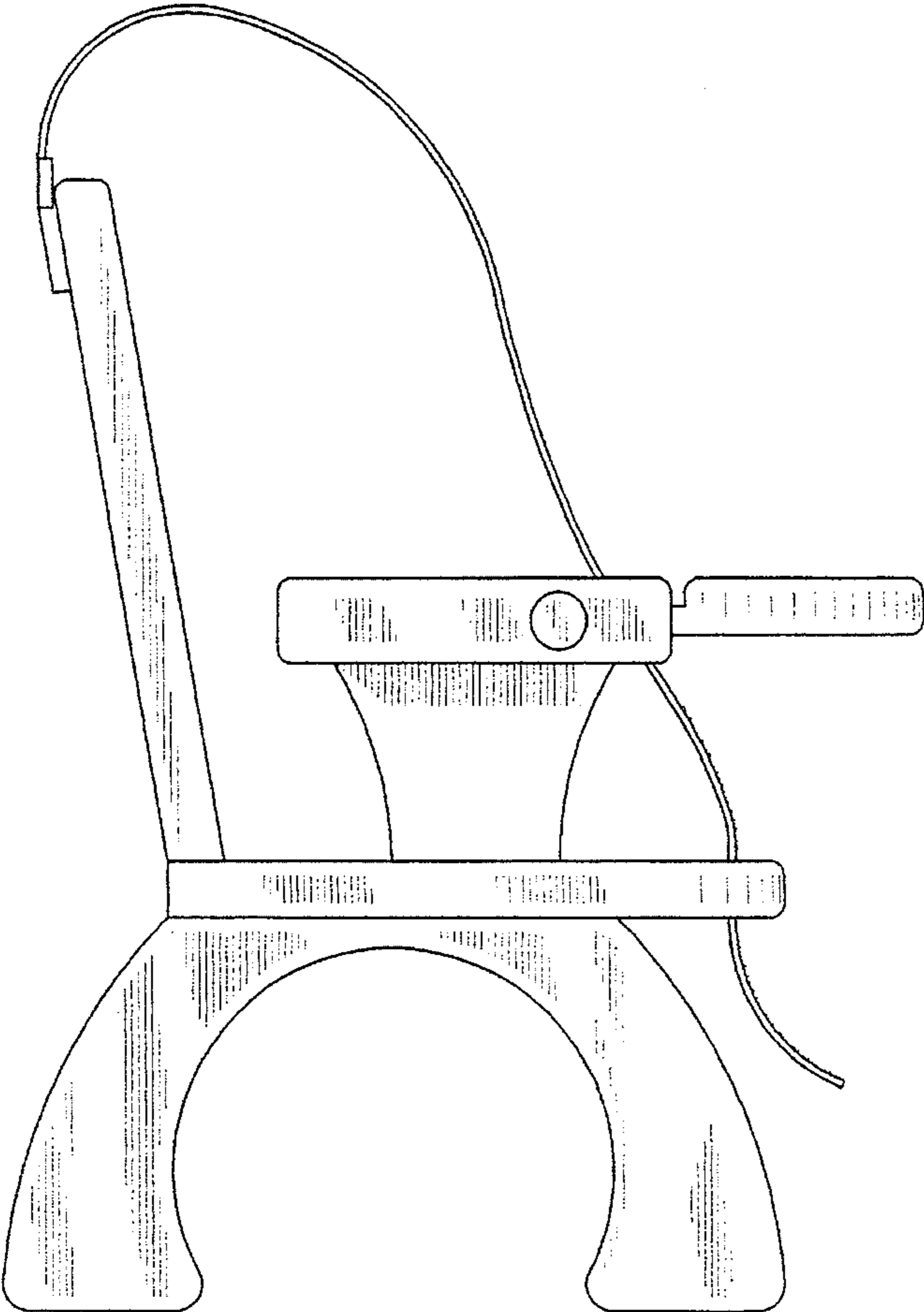

FIG. 4

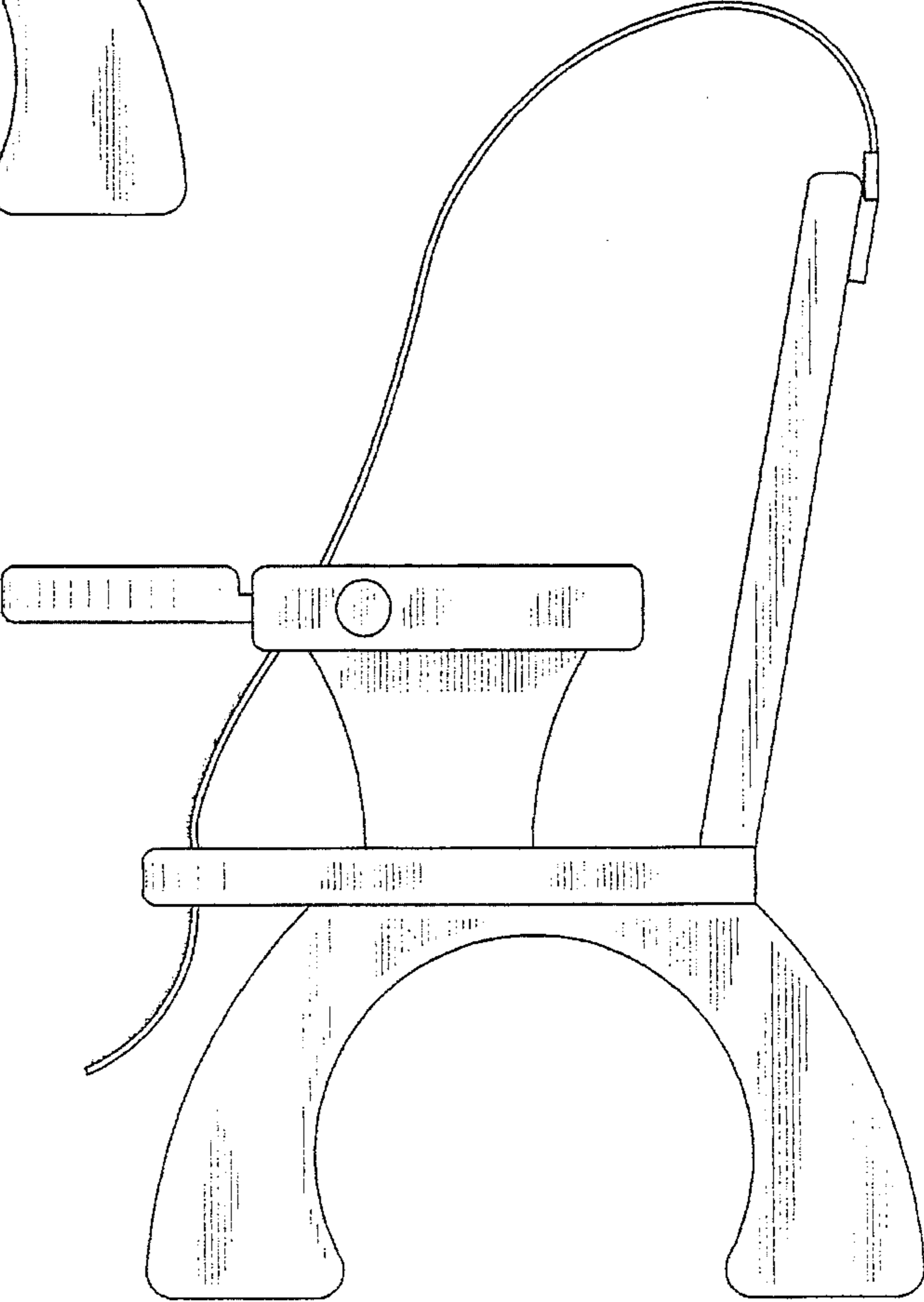

FIG. 5

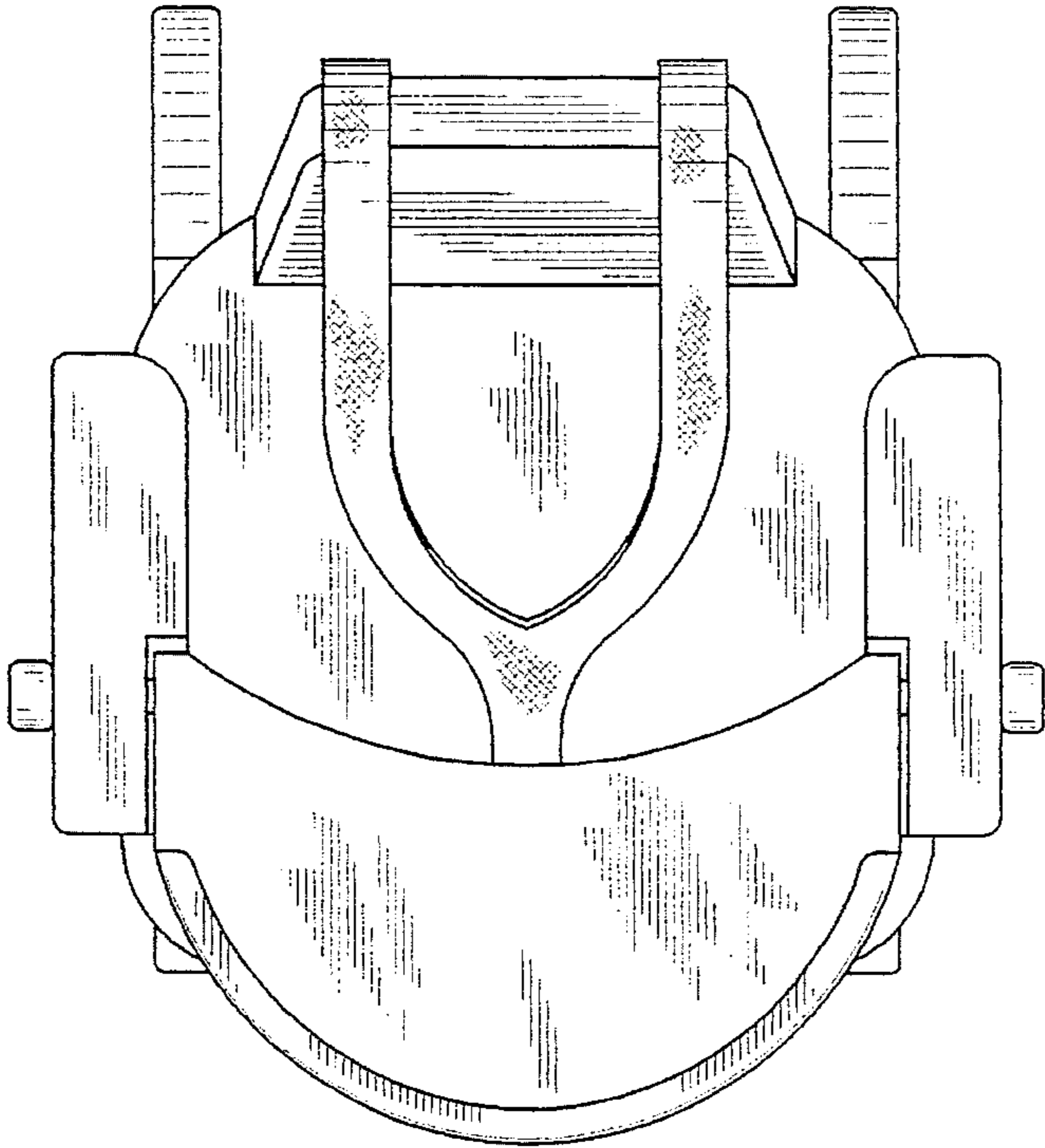

FIG. 6

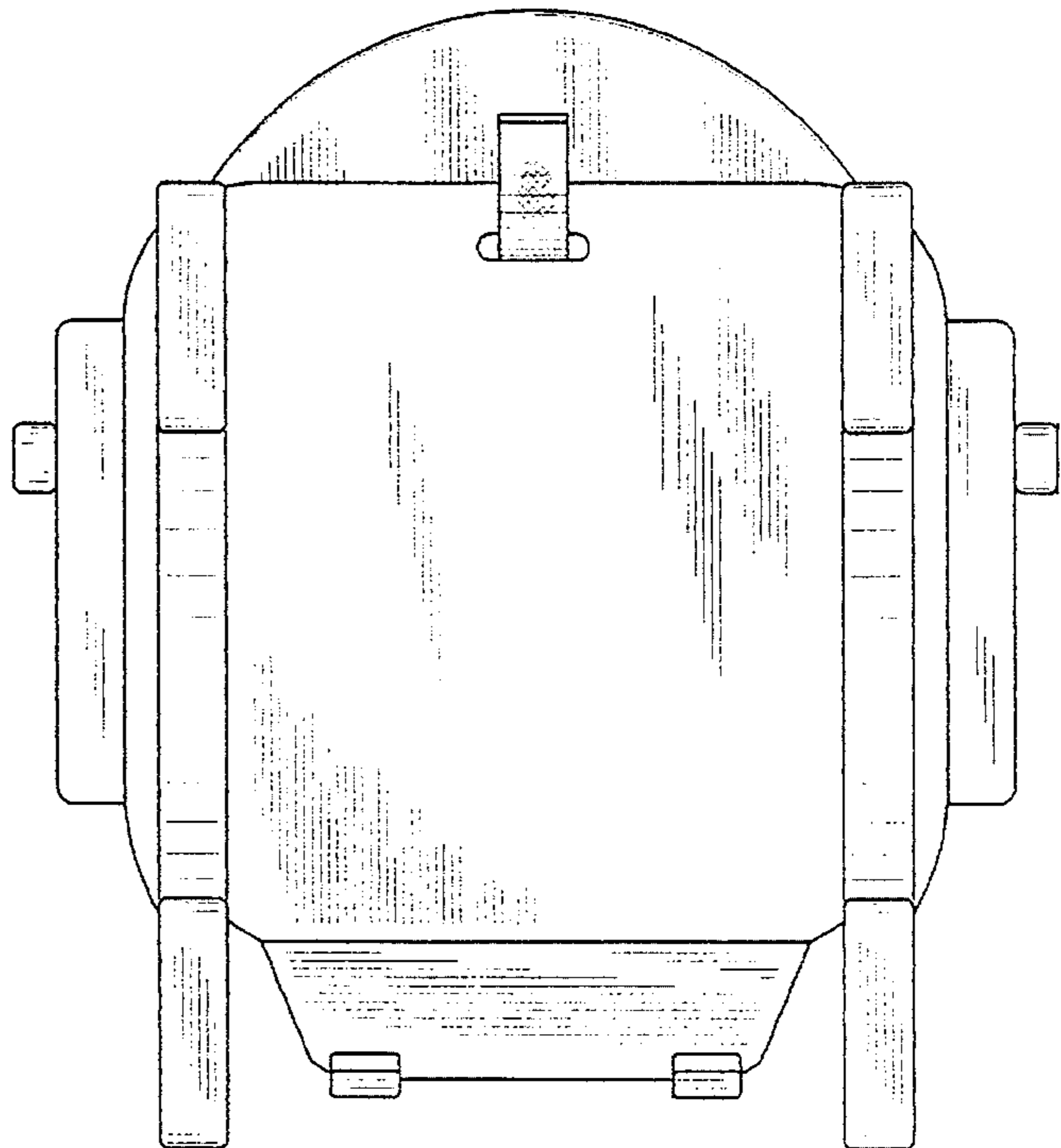

FIG. 7

