



US00D362960S

United States Patent [19]

[11] Patent Number: **Des. 362,960**

Stein

[45] Date of Patent: ****Oct. 10, 1995**

[54] **RECLOSABLE POUCH WORN ABOUT THE WAIST**

Attorney, Agent, or Firm—Dinsmore & Shohl

[76] Inventor: **Alvin W. Stein**, 3245 Lamarque Dr., Cincinnati, Ohio 45236

[57] **CLAIM**

The ornamental design for the reclosable pouch worn about the waist, as shown and described.

[**] Term: **14 Years**

DESCRIPTION

[21] Appl. No.: **22,483**

FIG. 1 is a top plan view of a reclosable pouch worn about the waist embodying my new design;

[22] Filed: **May 5, 1994**

FIG. 2 is a front elevational view of the pouch of FIG. 1;

[52] U.S. Cl. **D3/226; D3/234; D3/270**

FIG. 3 is a bottom plan view of the pouch of FIG. 1;

[58] **Field of Search** D3/226, 217, 215, D3/270, 221, 229, 257, 224, 271; 224/153, 154, 213, 919, 226, 224, 222, 223, 227, 228, 229; D21/204, 205; 273/58 R, 411

FIG. 4 is a rear elevational view of the pouch of FIG. 1;

FIG. 5 is a right side elevational view of the pouch of FIG. 1, the left side being a mirror image thereof;

[56] **References Cited**

U.S. PATENT DOCUMENTS

D. 92,706	10/1934	Dahlquist .	
D. 110,933	8/1938	Steffen .	
D. 128,495	7/1941	Loeb	D21/204 X
D. 235,693	7/1975	Tibbs	D3/238
D. 252,173	6/1979	Woods	D3/229
D. 257,184	10/1980	Peham .	
D. 279,137	6/1985	Sing .	
D. 289,226	4/1987	Zisholtz	D3/221
D. 292,342	10/1987	Schegel .	
D. 301,383	6/1989	Pesta .	
D. 303,036	8/1989	Giles .	
D. 313,496	1/1991	Pesta .	
D. 333,570	3/1993	Murray	D3/226
D. 337,645	7/1993	Guziejka .	
D. 340,073	10/1993	Turner	D21/204 X
D. 345,049	3/1994	Pollack	D3/217
2,735,109	2/1956	Feldman .	
5,282,278	2/1994	Miner	2/195.1

FIG. 6 is a front elevational view of a first alternative embodiment of the pouch embodying my new design;

FIG. 7 is a front elevational view of a second alternative embodiment of the pouch embodying my new design;

FIG. 8 is a front elevational view of a third alternative embodiment of the pouch embodying my new design;

FIG. 9 is a top plan view of a fourth alternative embodiment of the pouch embodying my new design;

FIG. 10 is a front elevational view of the pouch of FIG. 9;

FIG. 11 is a bottom plan view of the pouch of FIG. 9;

FIG. 12 is a rear elevational view of the pouch of FIG. 9;

FIG. 13 is a right side elevational view of the pouch of FIG. 9, the left side being a mirror image thereof;

FIG. 14 is a front elevational view of a fifth alternative embodiment of the pouch embodying my new design;

FIG. 15 is a perspective view of the pouch of FIG. 9; and, FIG. 16 is a perspective view of the pouch of FIG. 2.

The broken line showing of a belt is for illustrative purposes only and forms no part of the claimed design. It should be known that the individual panels shown in each drawing can be decorated with colors, logos, designs and the like.

Primary Examiner—Lou Zarfaz
Assistant Examiner—Catherine R. Oliver

1 Claim, 4 Drawing Sheets

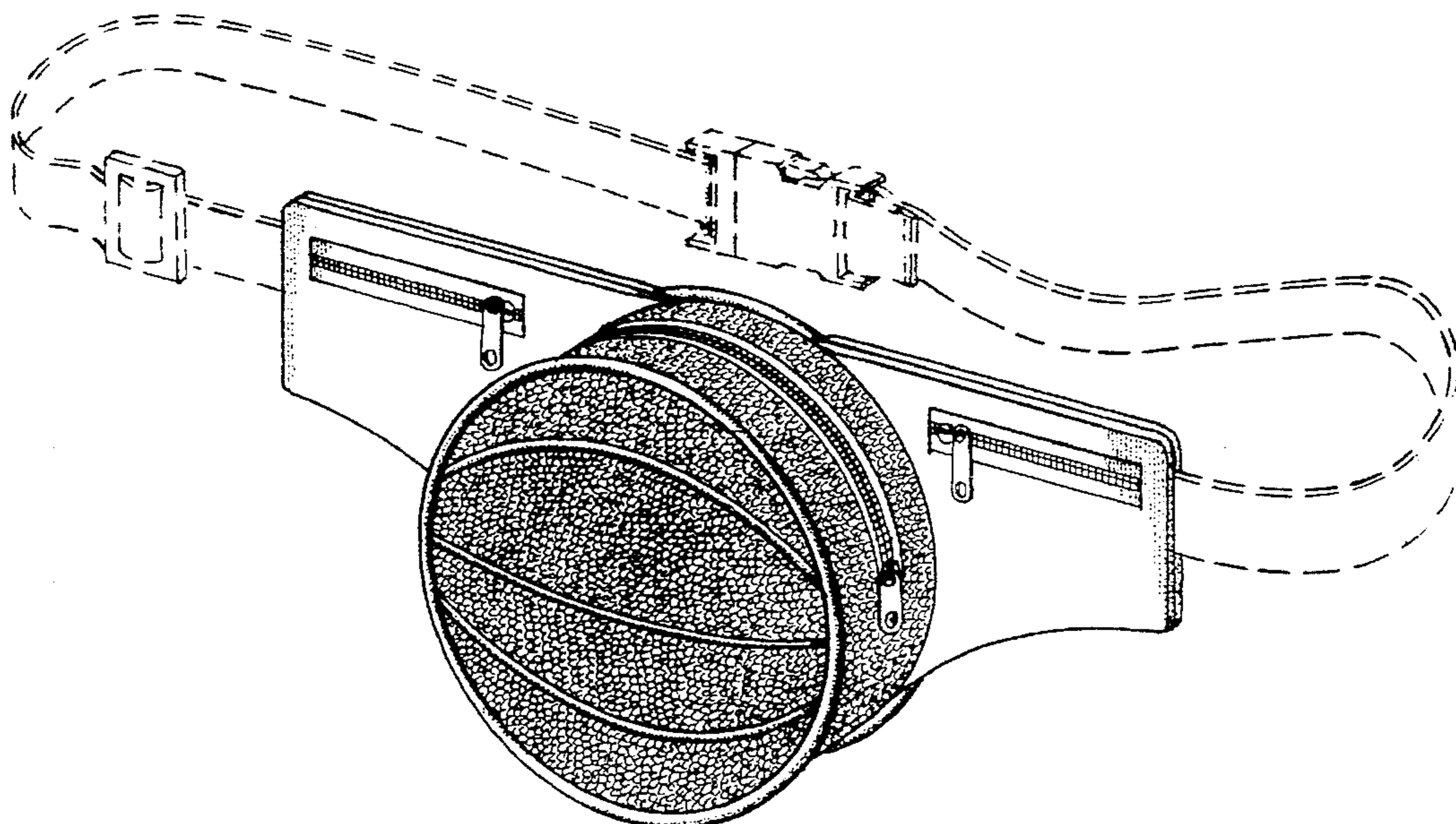

Fig. 1

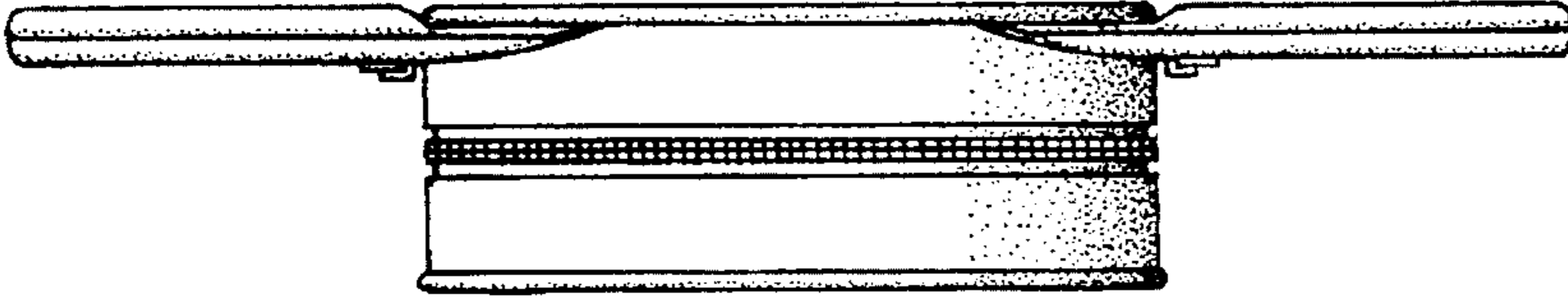

Fig. 2

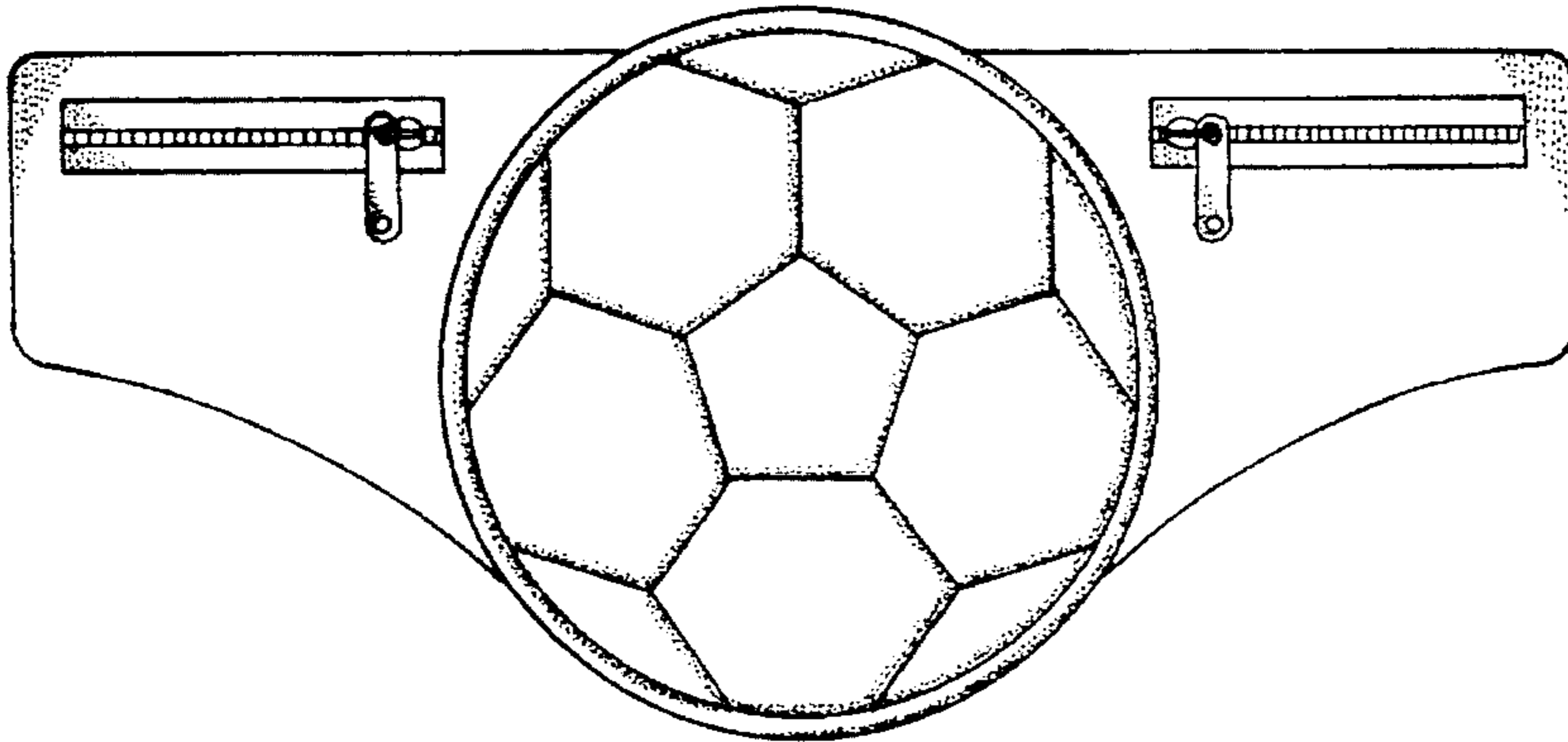

Fig. 5

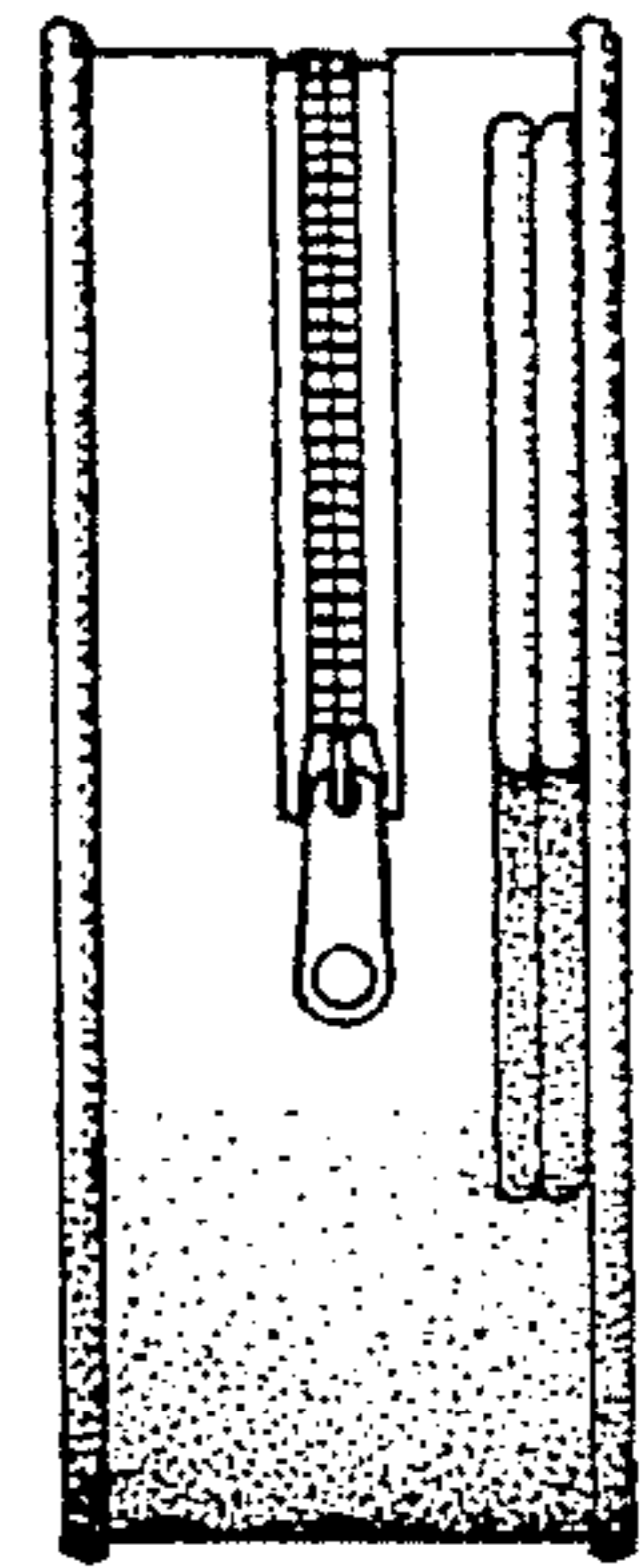

Fig. 3



Fig. 4

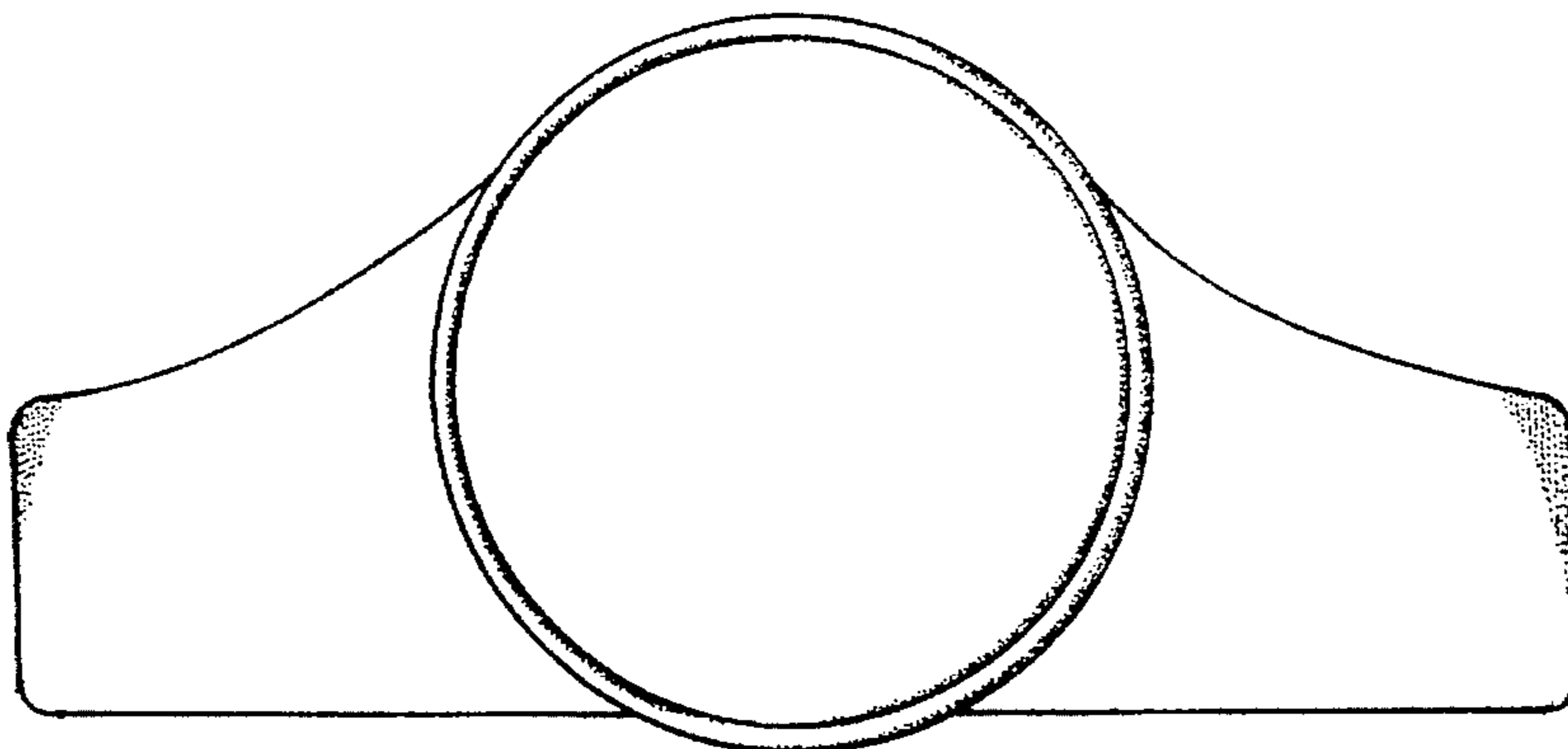

Fig. 6

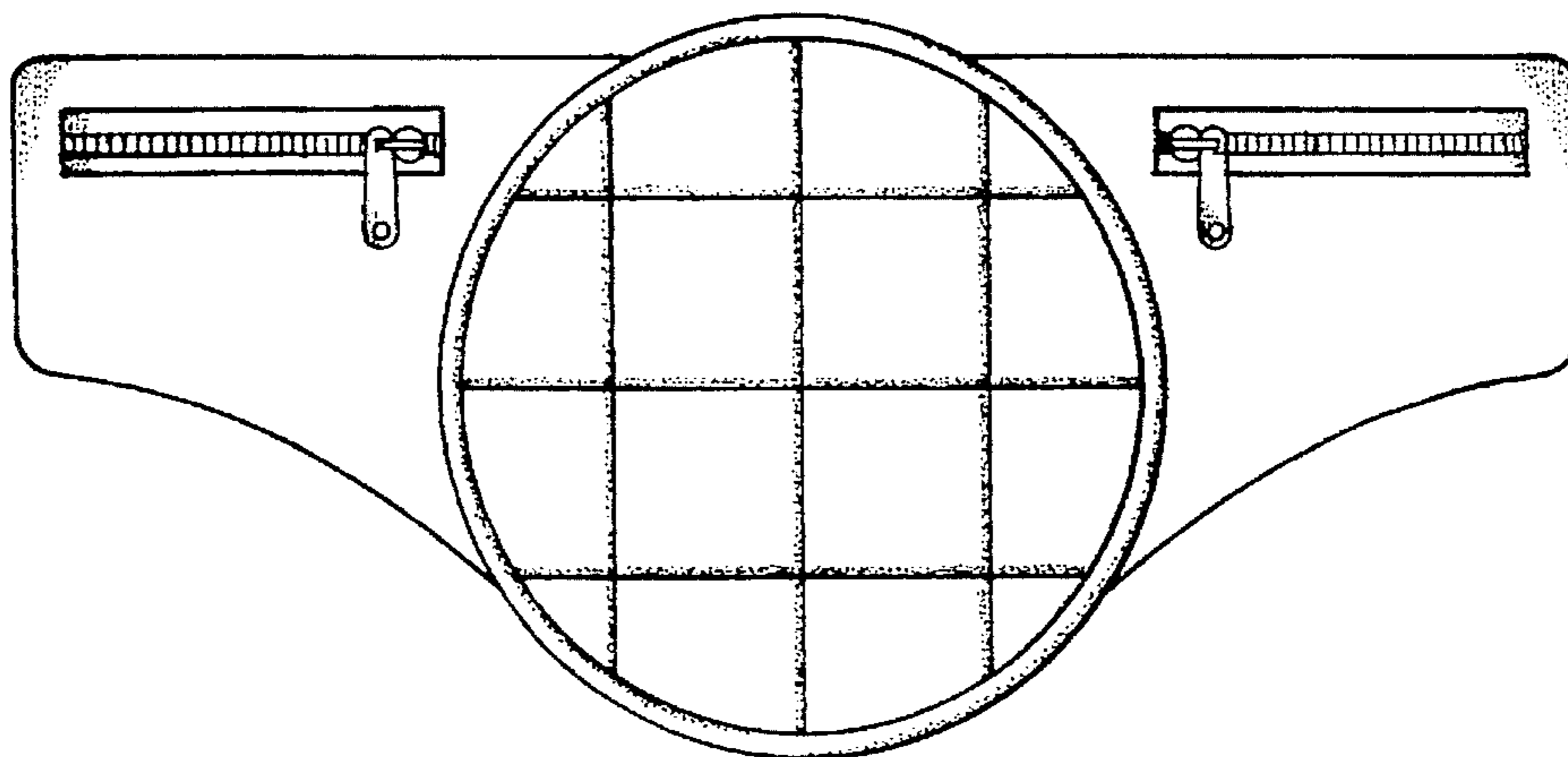

Fig. 7

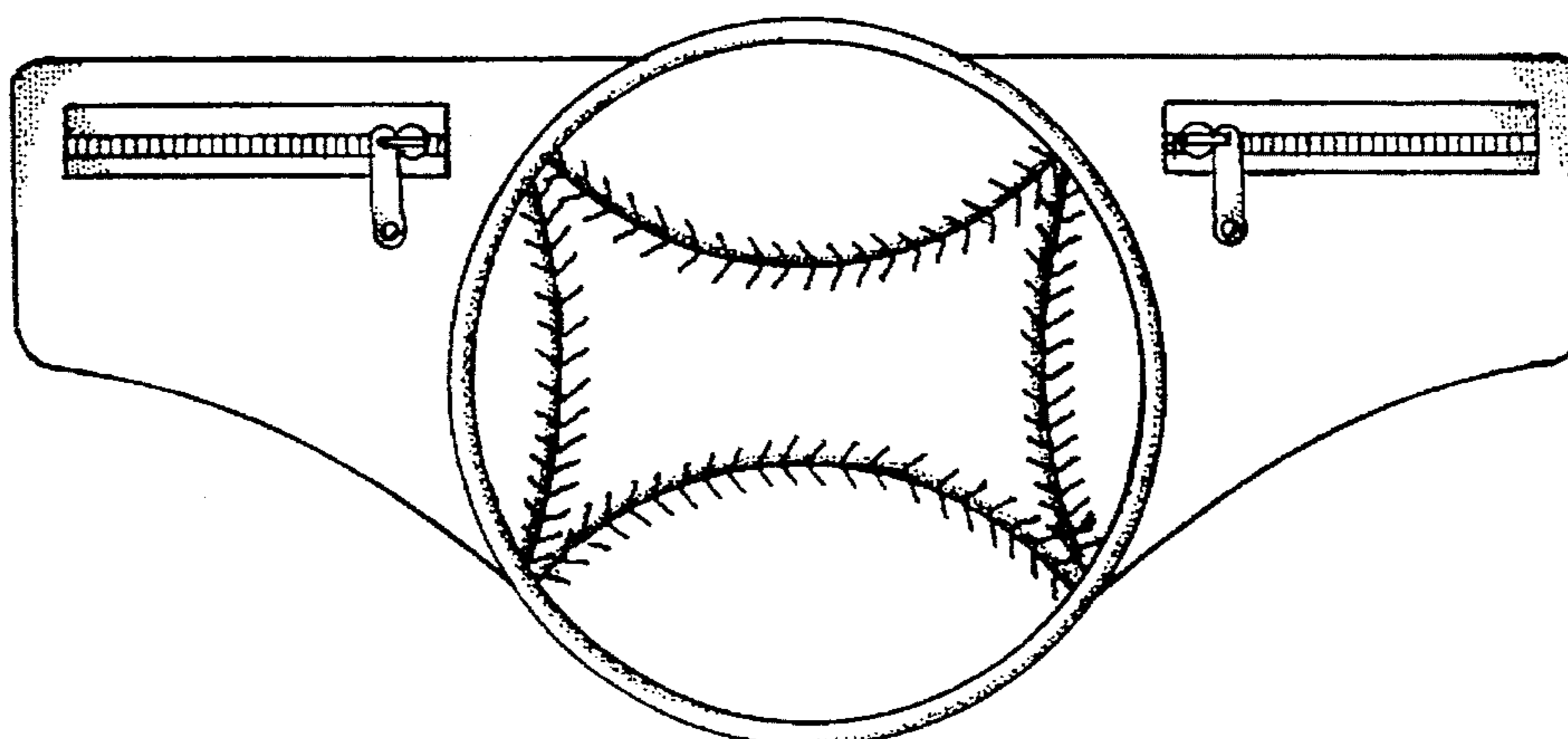

Fig. 8

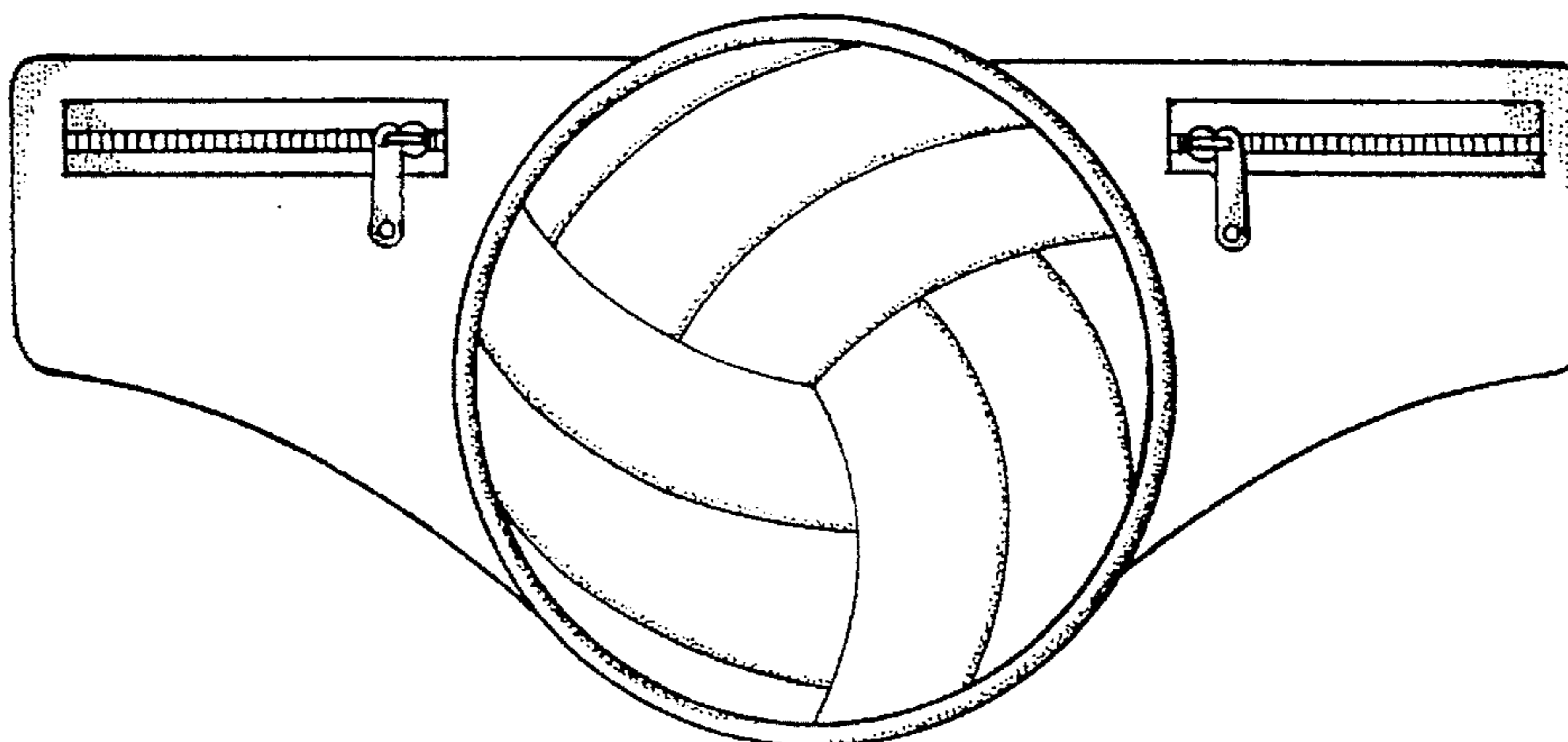

Fig. 9

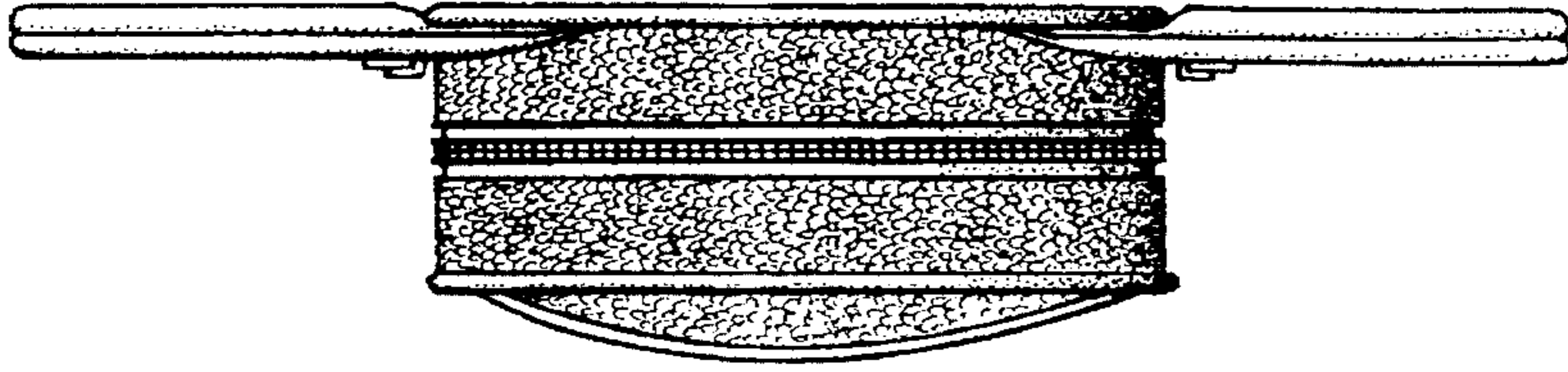

Fig. 10

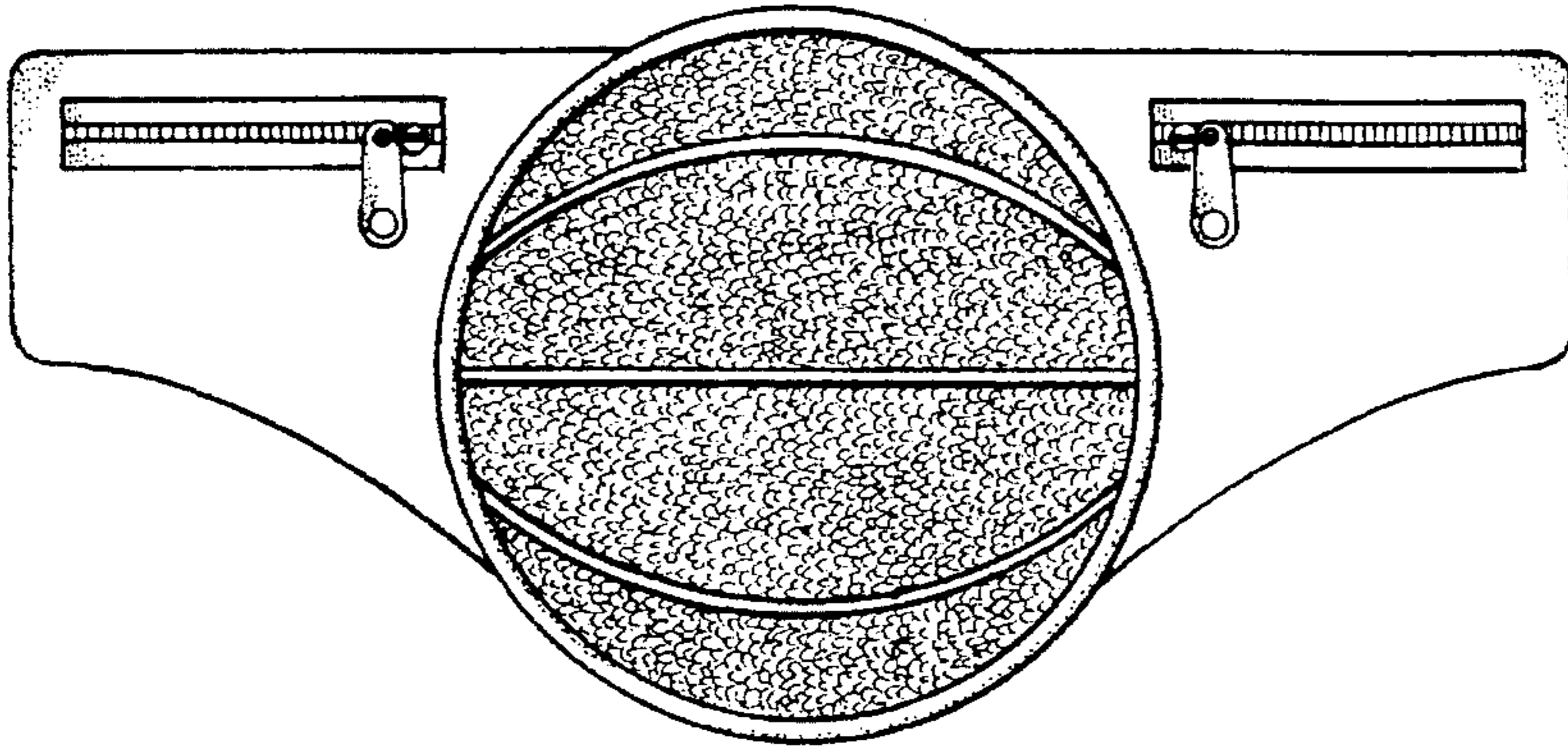

Fig. 13

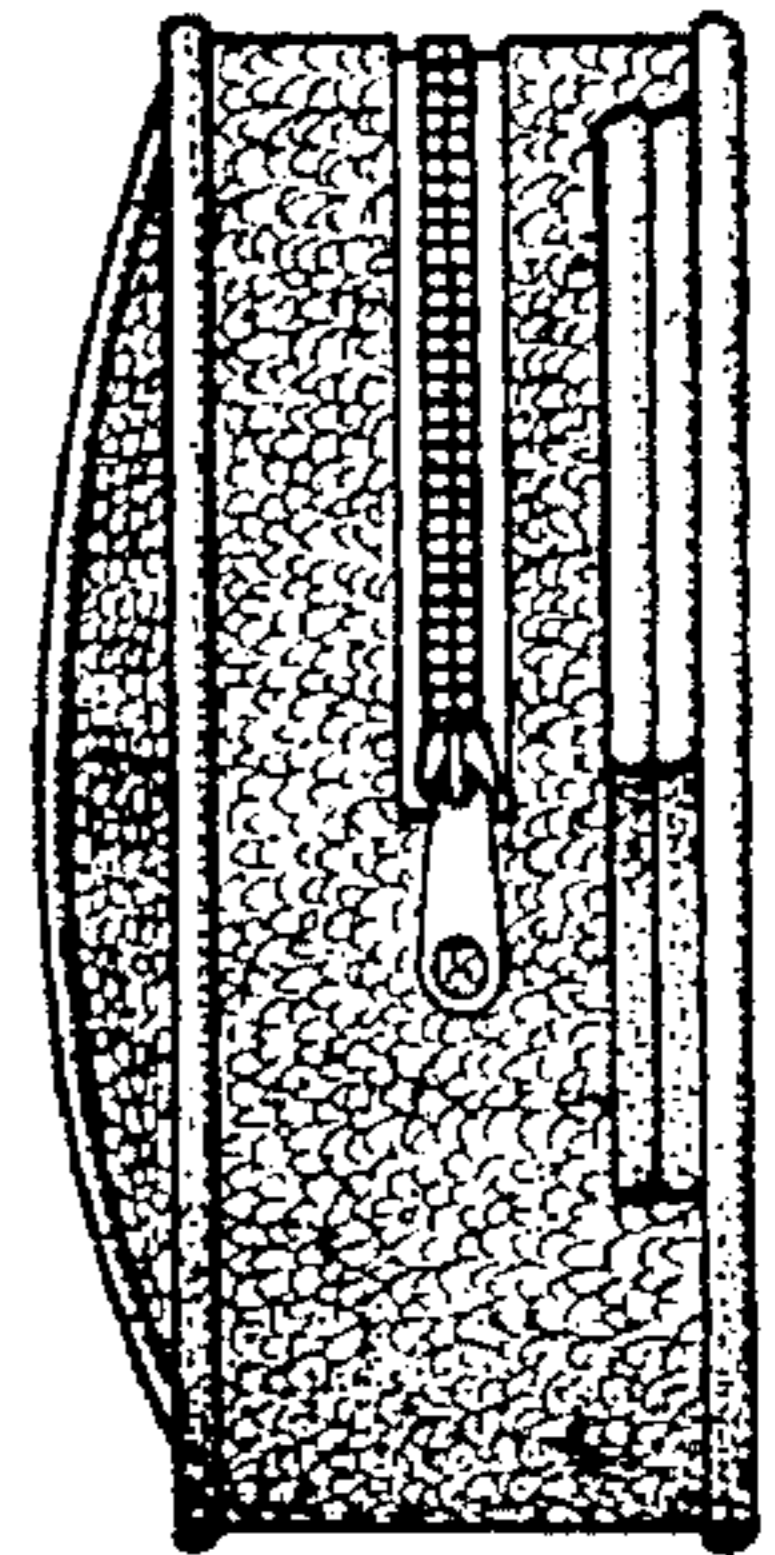

Fig. 11

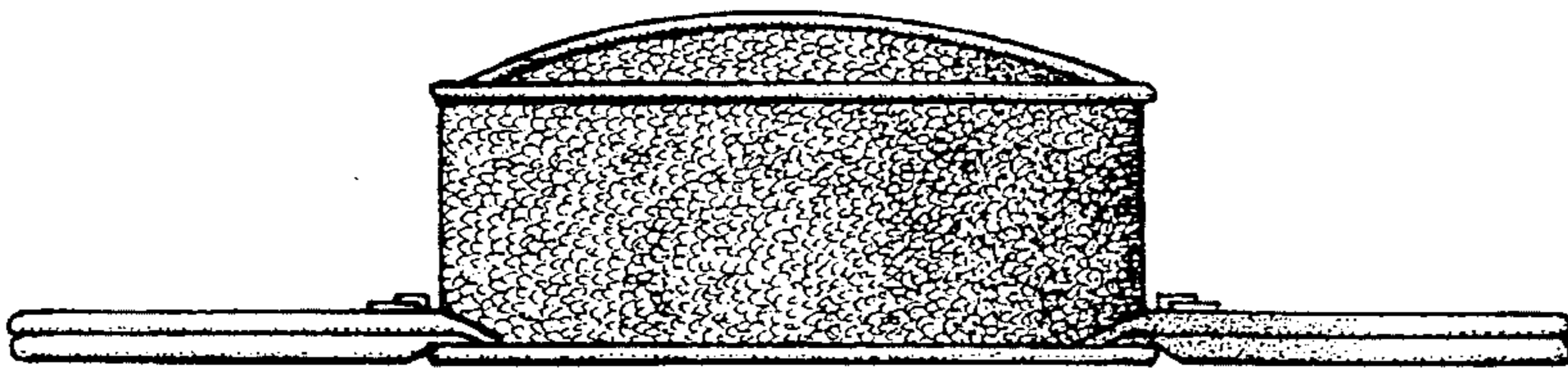

Fig. 12

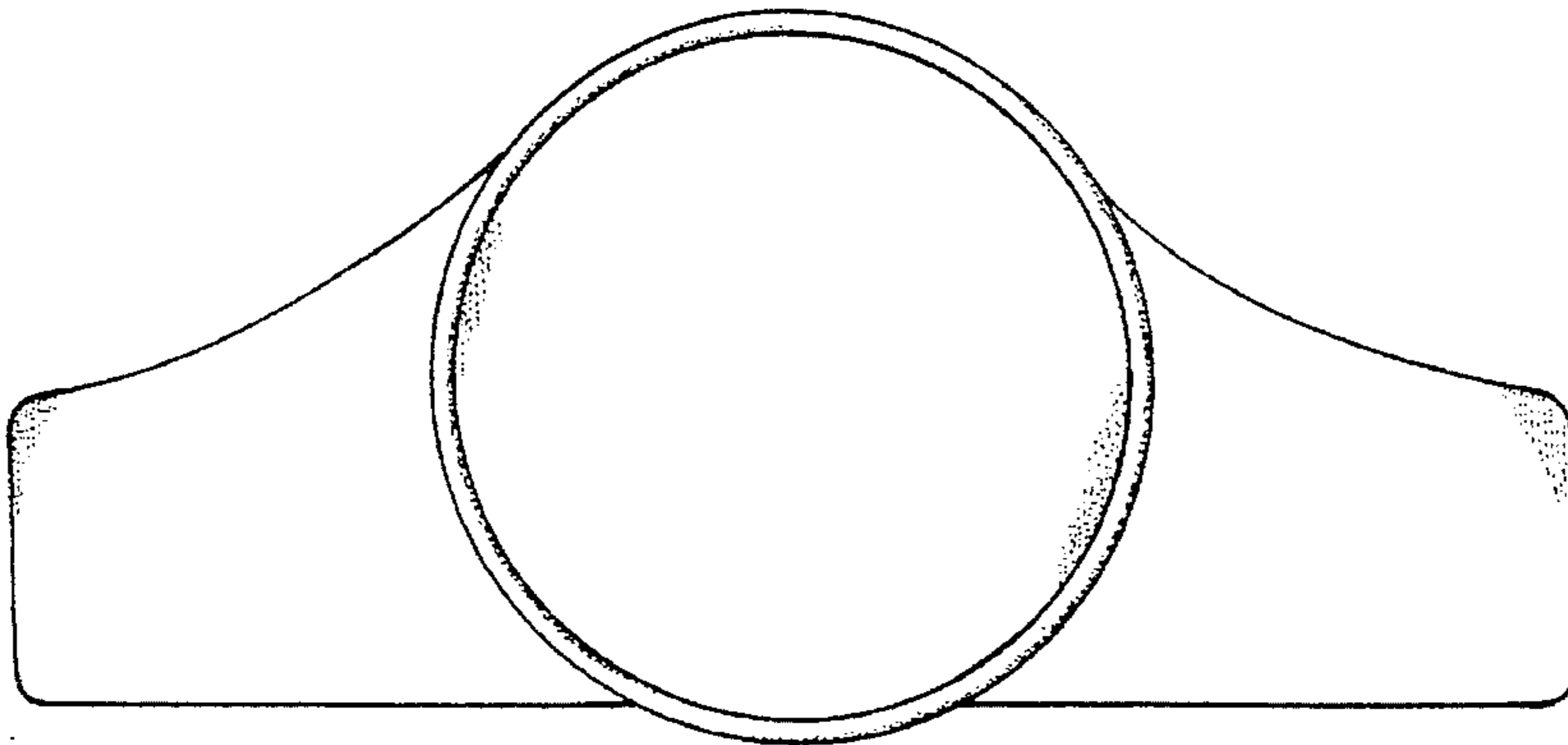

Fig. 14

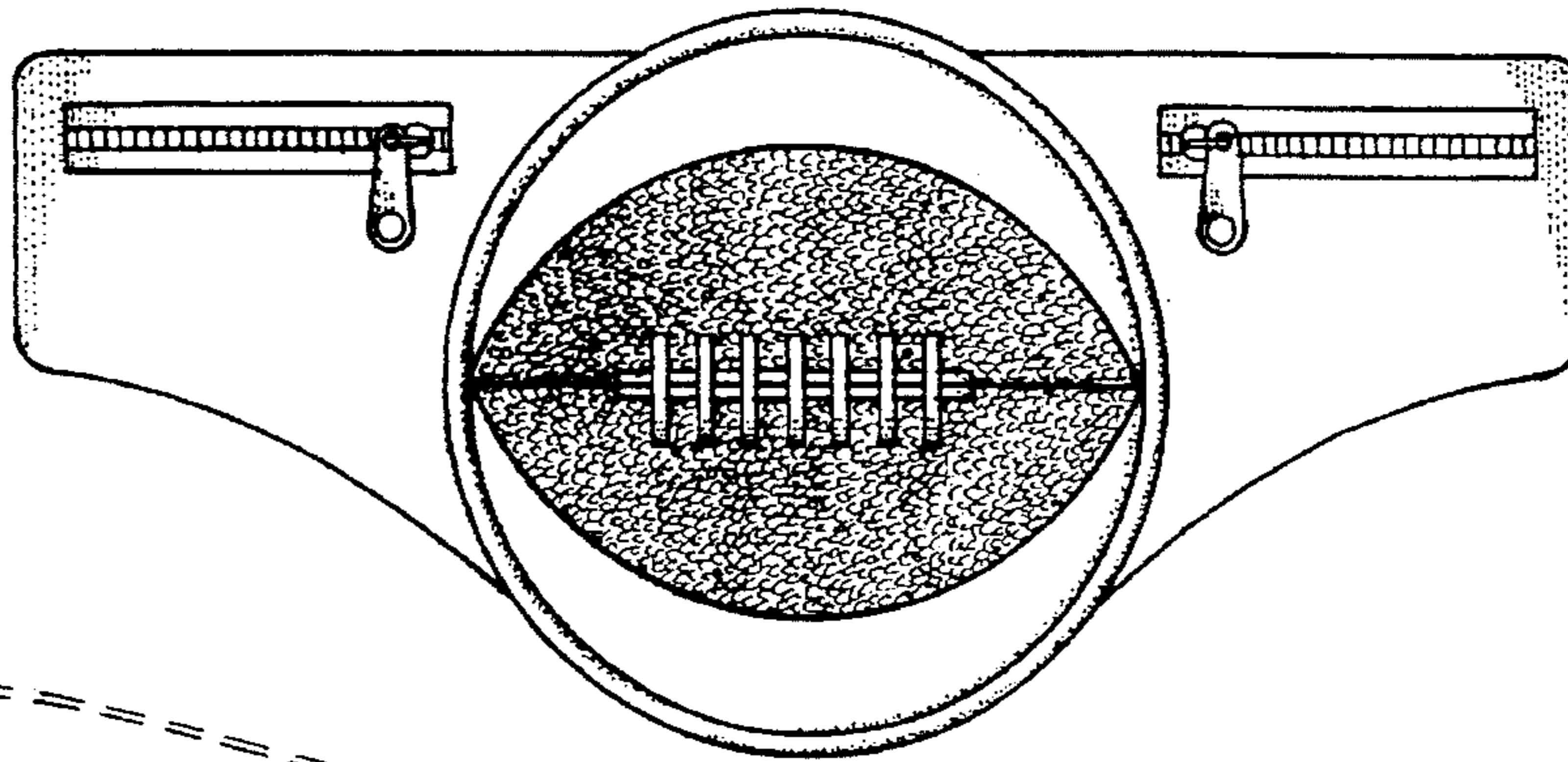

Fig. 15

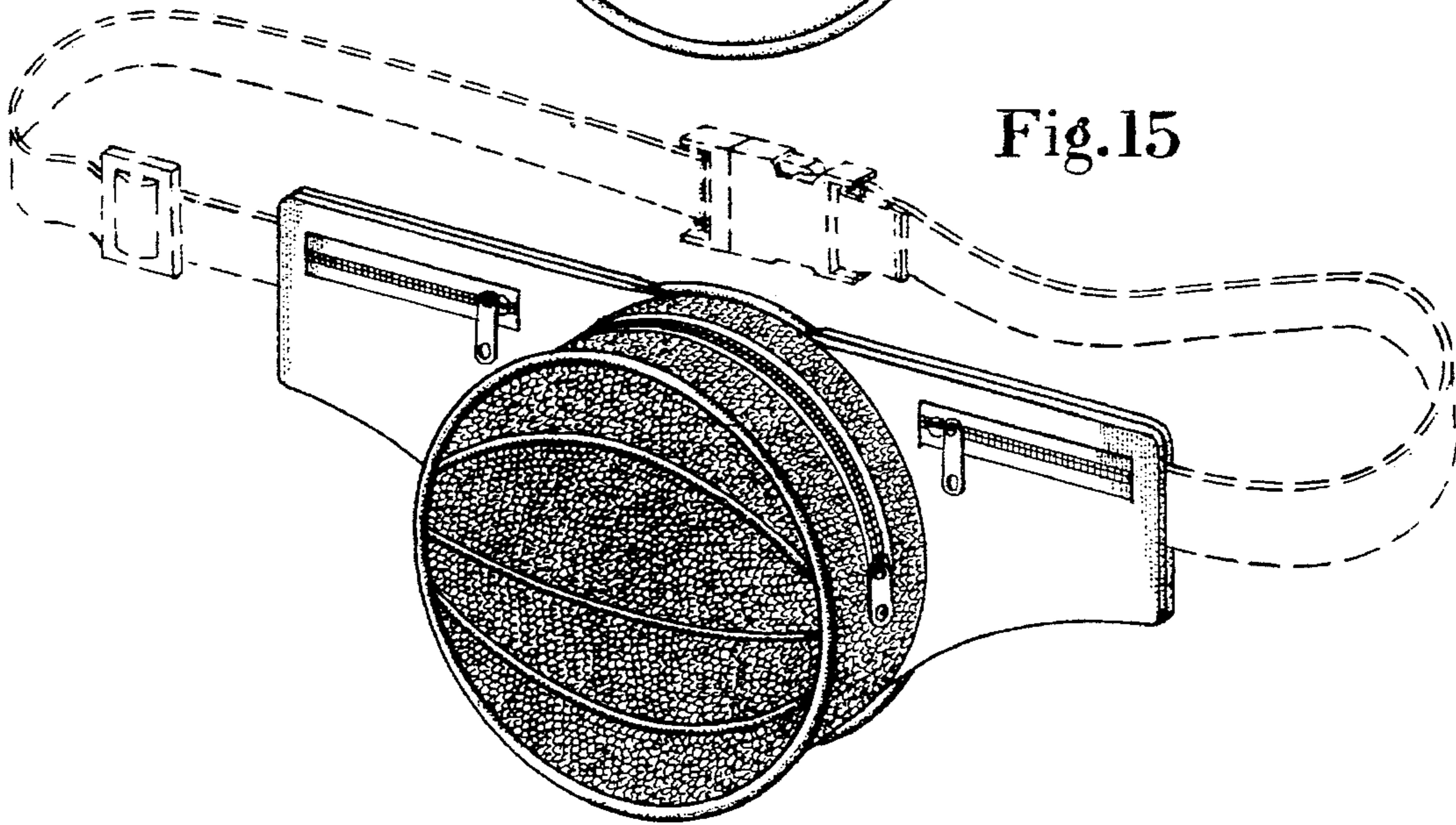

Fig. 16

