



US00D362942S

# United States Patent [19]

[11] Patent Number: **Des. 362,942**

Licari

[45] Date of Patent: **\*\*Oct. 3, 1995**

[54] **DISH DRAIN RACK**

D. 321,771 11/1991 Cavicchia ..... D32/55

[76] Inventor: **Yaffa Licari**, 875 Ocean Ave., Elberon, N.J. 07740

*Primary Examiner*—A. Hugo Word  
*Assistant Examiner*—Robin V. Taylor

[\*\*] Term: **14 Years**

[57] **CLAIM**

The ornamental design for dish drain rack, as shown and described.

[21] Appl. No.: **29,260**

[22] Filed: **Oct. 3, 1994**

### DESCRIPTION

[52] U.S. Cl. .... **D32/55**

[58] Field of Search ..... D32/3, 55-58;  
D3/260, 304, 306; D6/462; 4/637-638,  
656; 211/13, 41; 248/128, 346; 220/571-572,  
487-488

FIG. 1 is a perspective view, taken from the top and front, right side, showing the disk drain rack of my new design; FIG. 2 is a top plan view thereof; FIG. 3 is a bottom plan view thereof; FIG. 4 is a rear elevational view thereof; FIG. 5 is a right side elevational view thereof, the left side being a mirror image; and, FIG. 6 is a front elevational view thereof.

### [56] References Cited

#### U.S. PATENT DOCUMENTS

D. 259,537 6/1981 Taylor ..... D32/55  
D. 280,454 9/1985 Andersson ..... D32/55

**1 Claim, 6 Drawing Sheets**

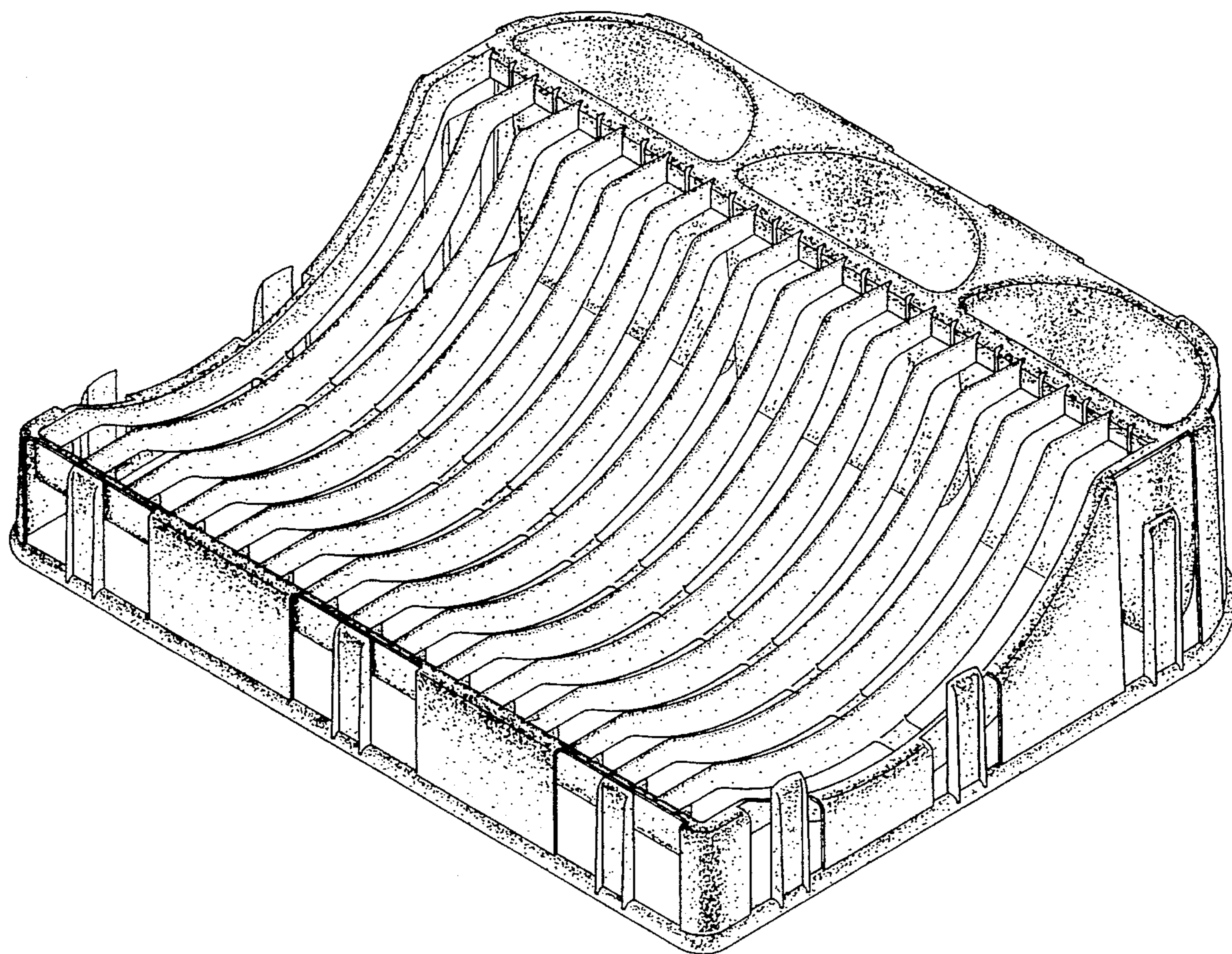
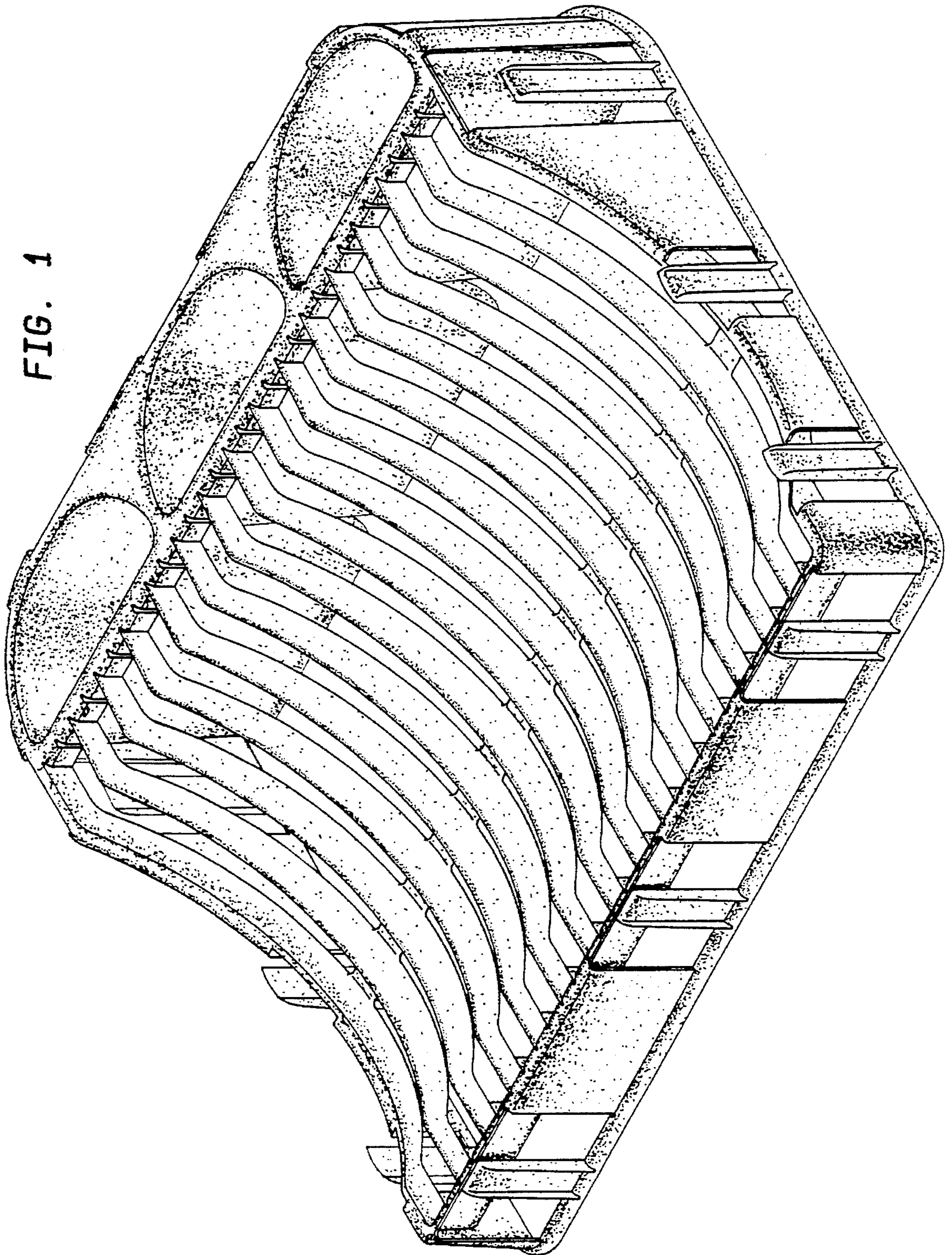

FIG. 1



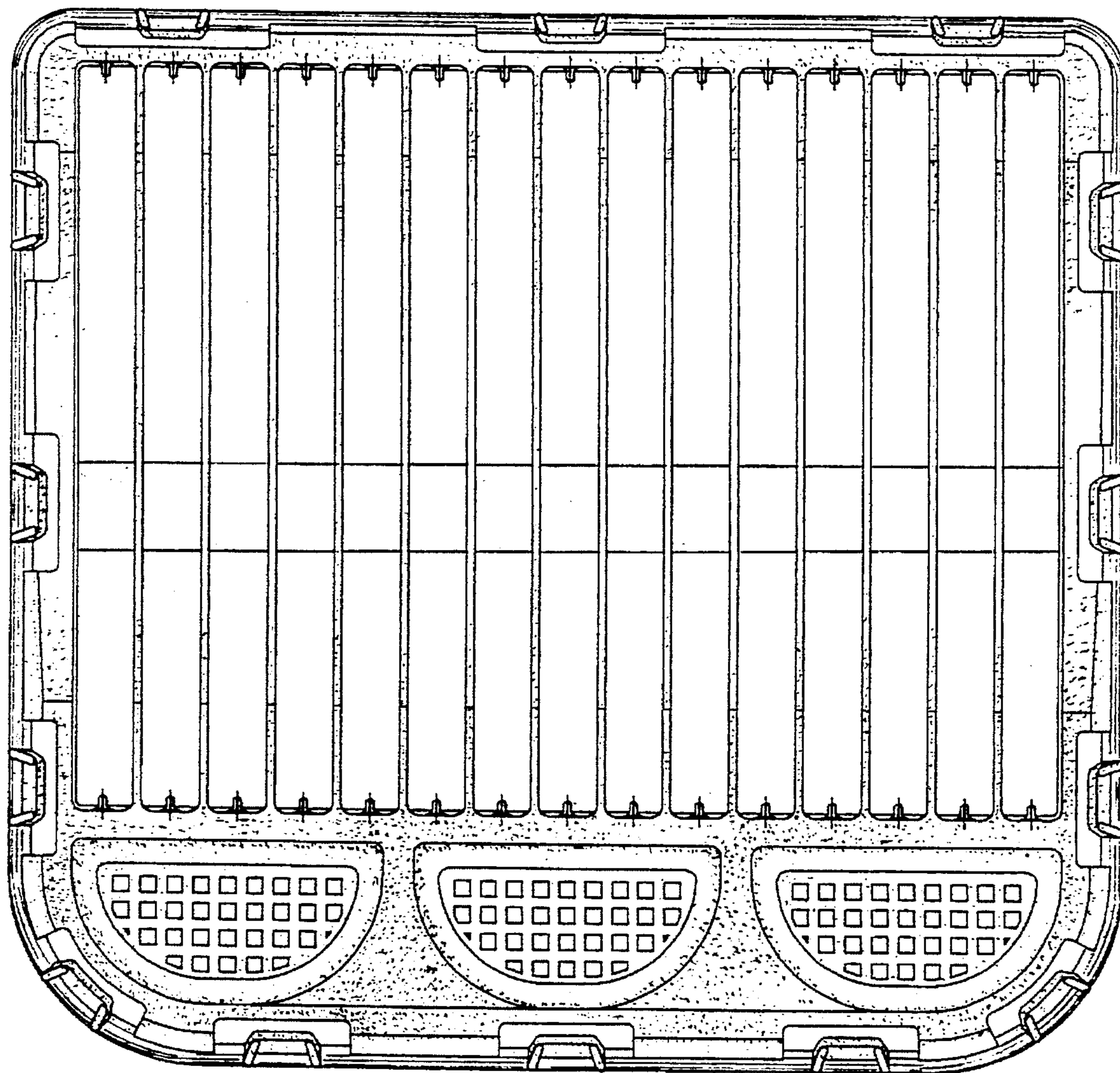

Fig. 2

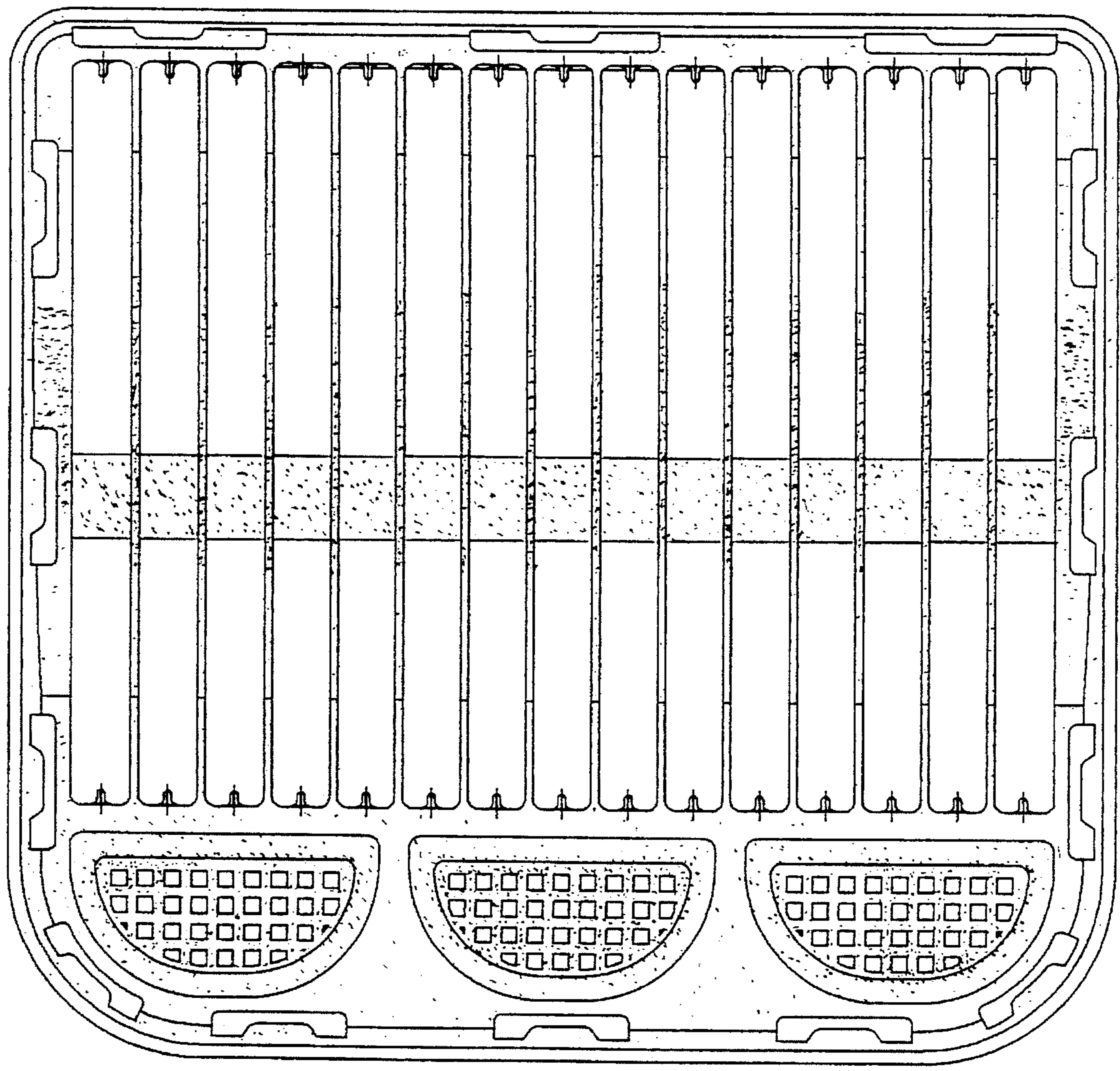

Fig. 3

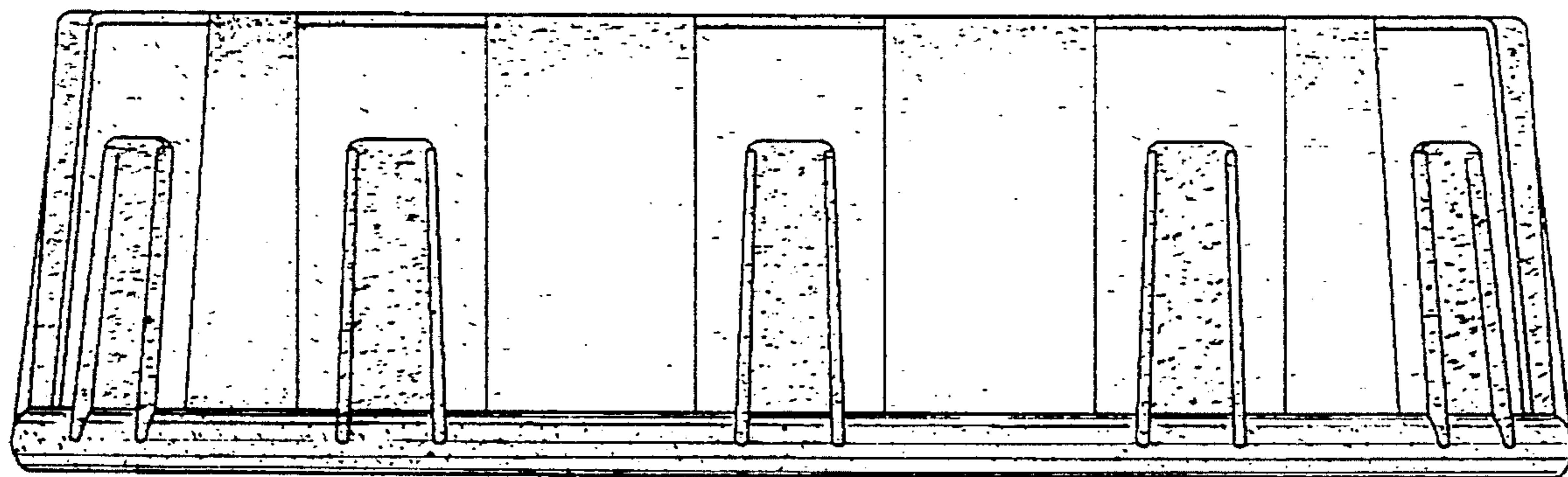

Fig. 4

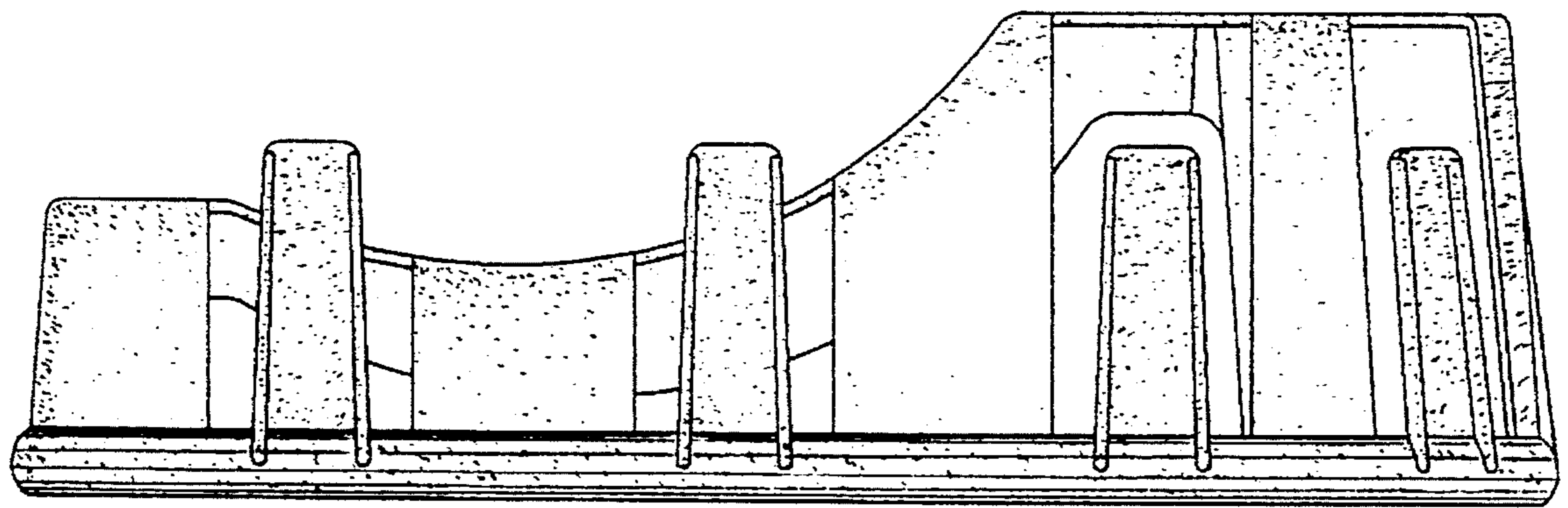

Fig. 5

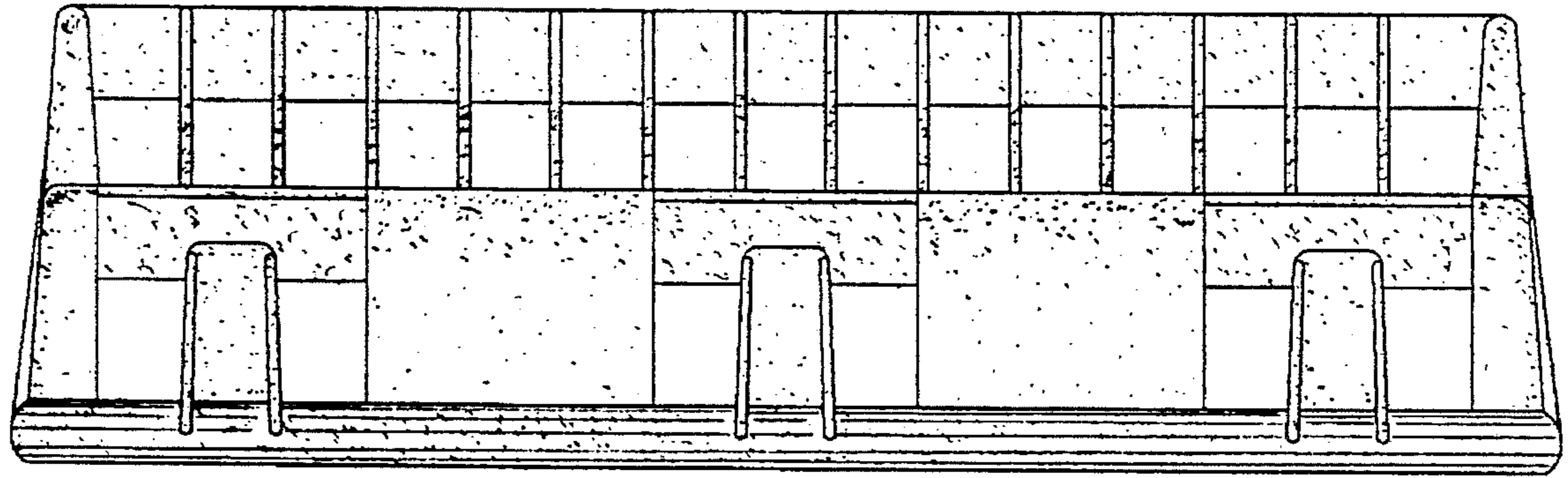

Fig. 6