



US00D362911S

United States Patent [19]

[11] Patent Number: **Des. 362,911**

Helms

[45] Date of Patent: ****Oct. 3, 1995**

[54] **COMBINED THERAPY CHAIR AND TABLE**

[76] Inventor: **Marcia A. Helms**, 263 Unionville - Indian Trail Rd., Indian Trail, N.C. 28079

[**] Term: **14 Years**

[21] Appl. No.: **12,523**

[22] Filed: **Sep. 3, 1993**

[52] U.S. Cl. **D24/188**

[58] Field of Search D24/188; 601/24, 601/23; 482/148, 142, 130; D21/191, 194

[56] **References Cited**

U.S. PATENT DOCUMENTS

3,072,400	1/1963	Dykinga	601/24	X
4,637,604	1/1987	DuPont	482/148	
4,662,361	5/1987	Patterson	601/24	
4,776,581	10/1988	Sheperdson	D24/188	X
5,020,795	6/1991	Airy et al.	601/24	X

Primary Examiner—Stella Reid
Attorney, Agent, or Firm—Clifton Ted Hunt

[57] **CLAIM**

The ornamental design for a combined therapy chair and table, as described and shown in the drawings.

DESCRIPTION

FIG. 1 is a front, side perspective view of a combined therapy chair and table, showing my new design, the broken line showing is for illustrative purposes only and forms no part of the claimed design;

FIG. 2 is a front elevation view thereof;

FIG. 3 is a side elevational view thereof;

FIG. 4 is a top plan view thereof;

FIG. 5 is a rear elevational view thereof; and,

FIG. 6 is a side elevational view thereof with the chair extended longitudinally from the table and the table elevated.

1 Claim, 5 Drawing Sheets

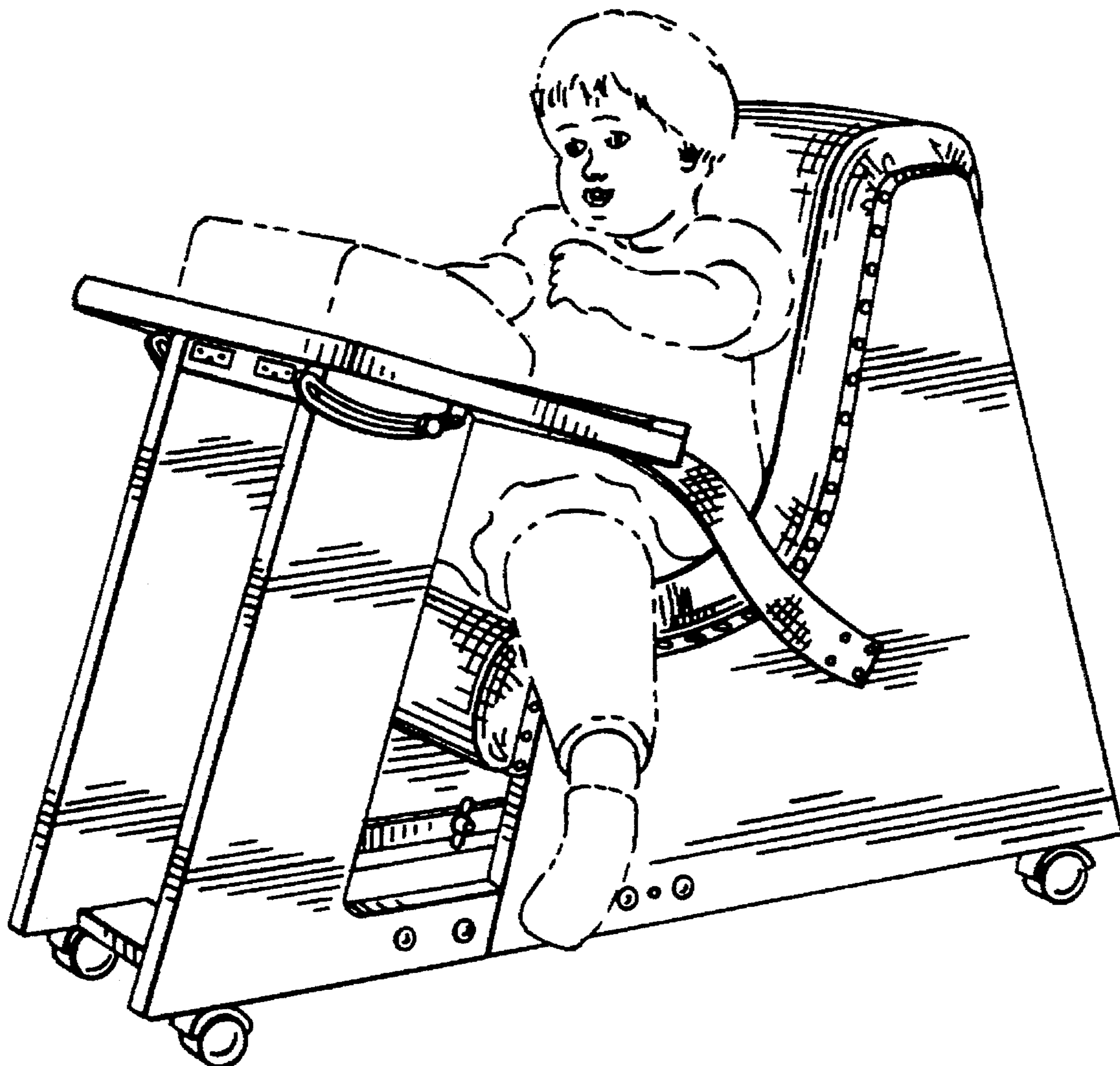

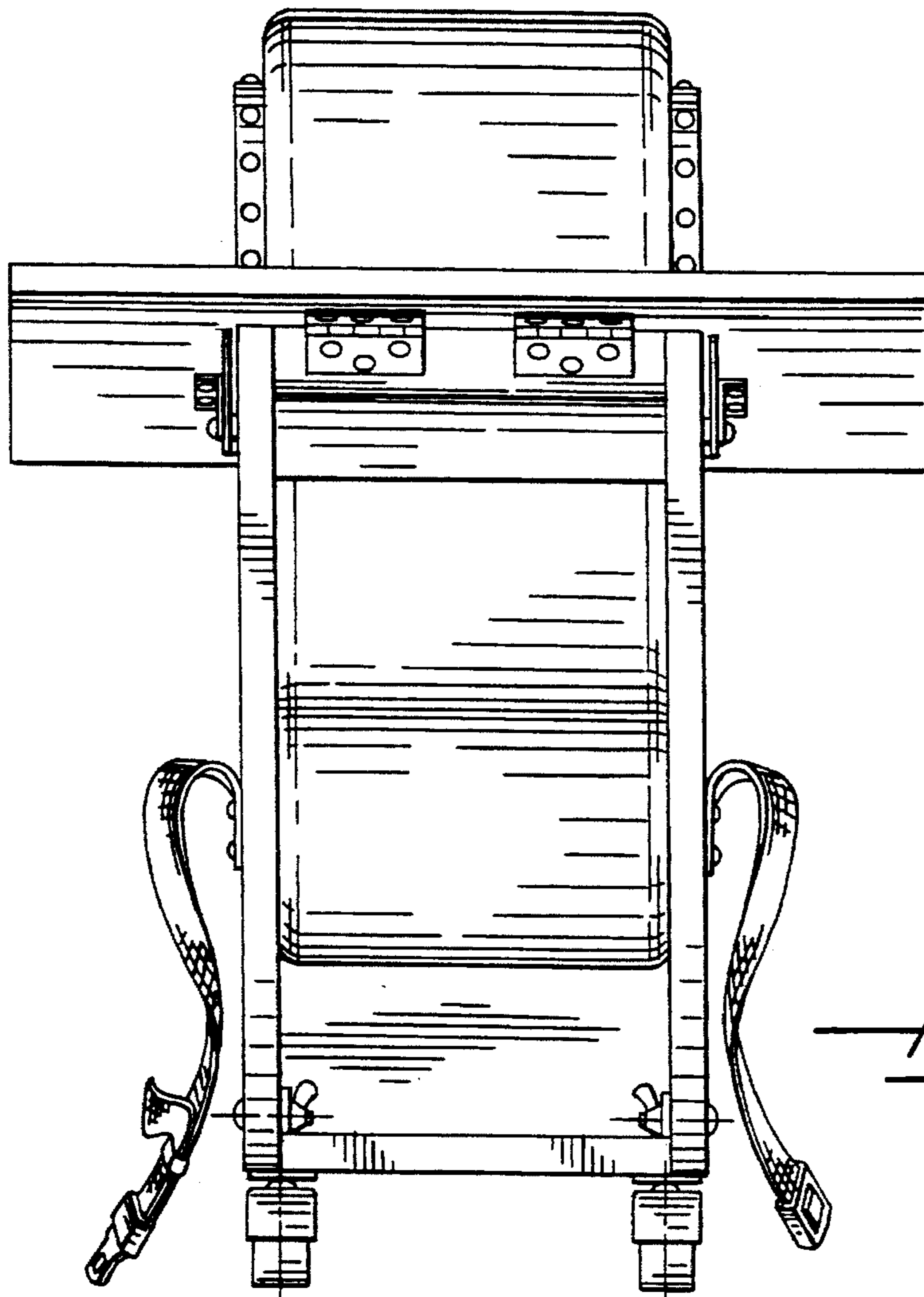
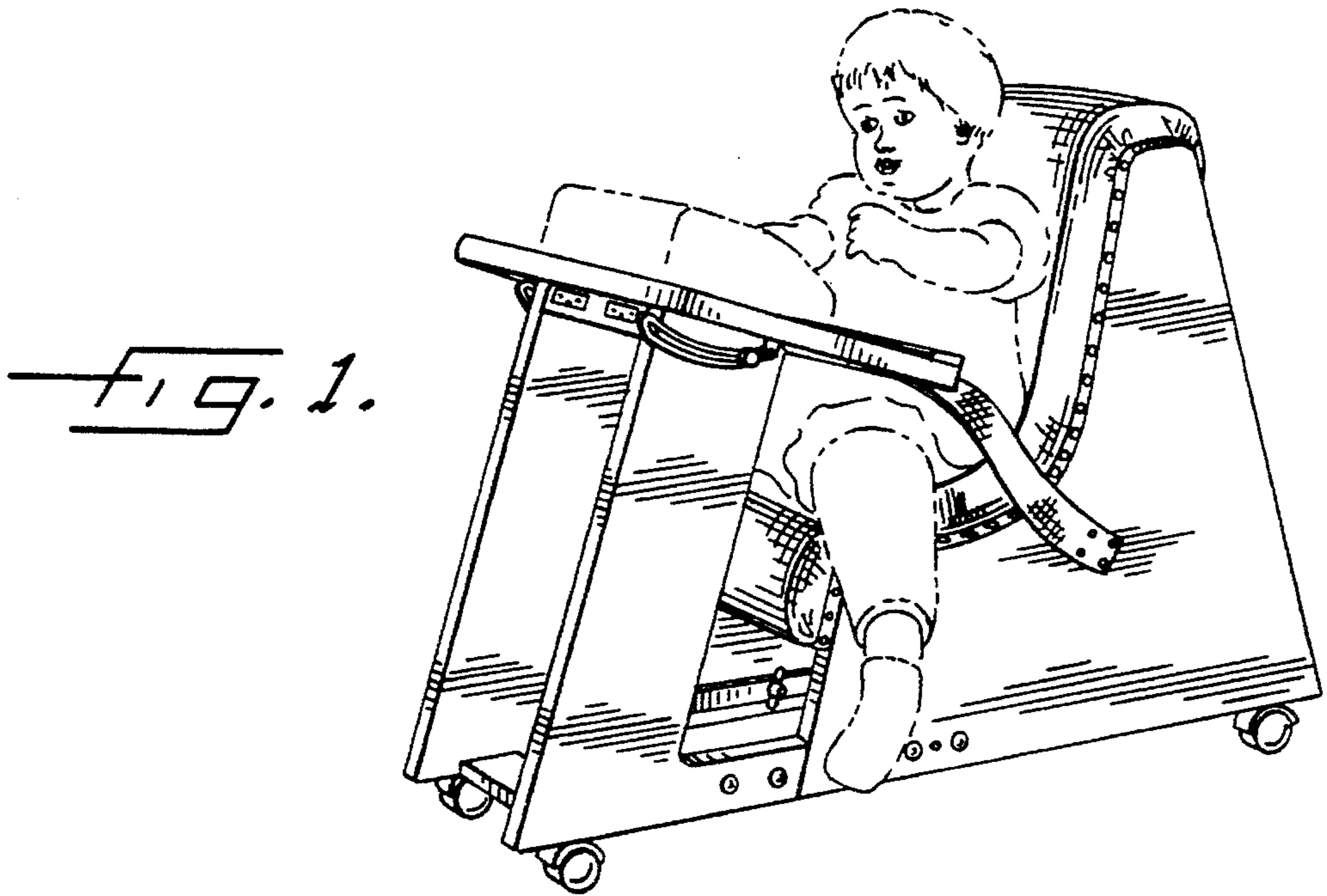

FIG. 2.

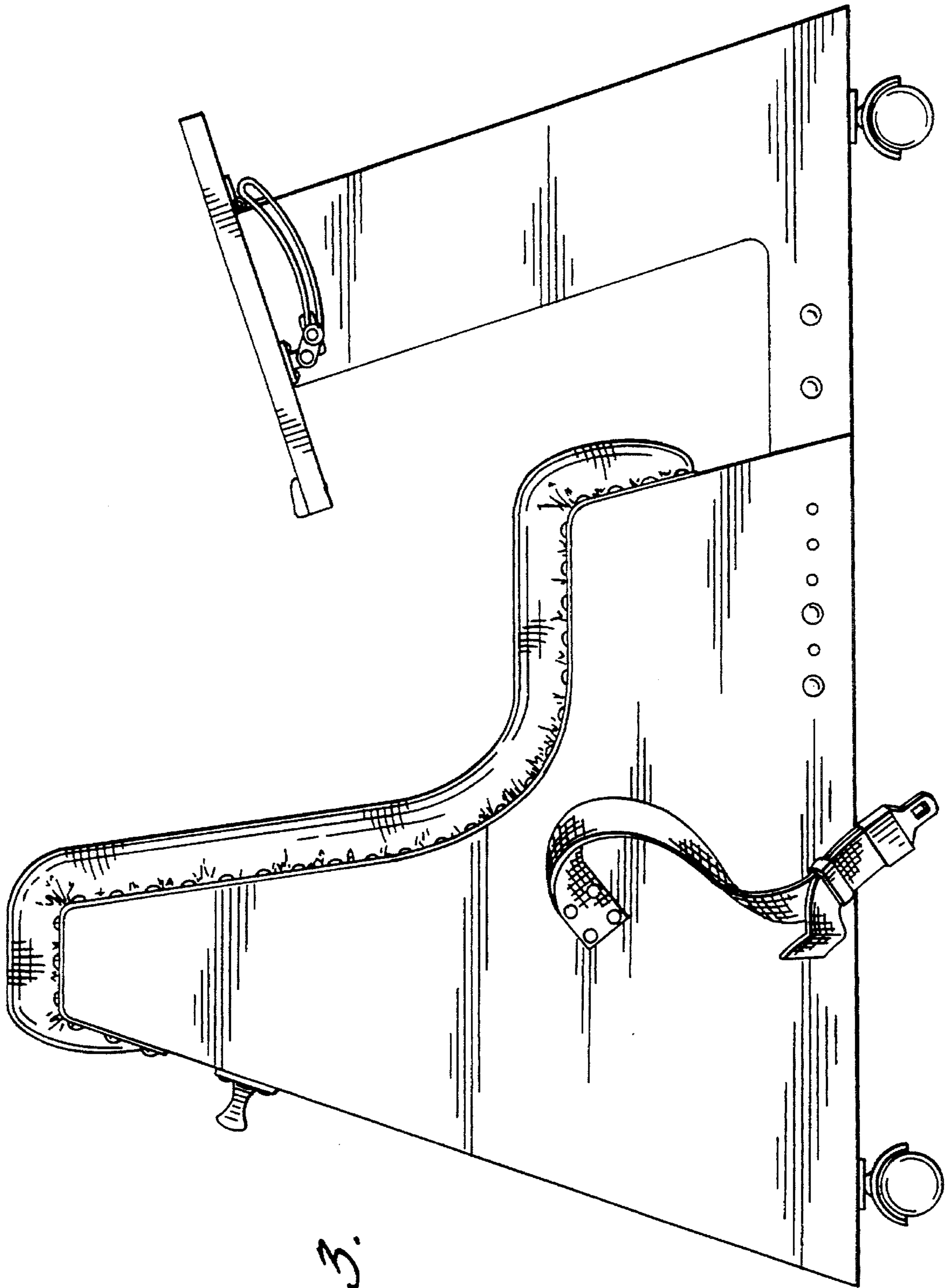

FIG. 3.

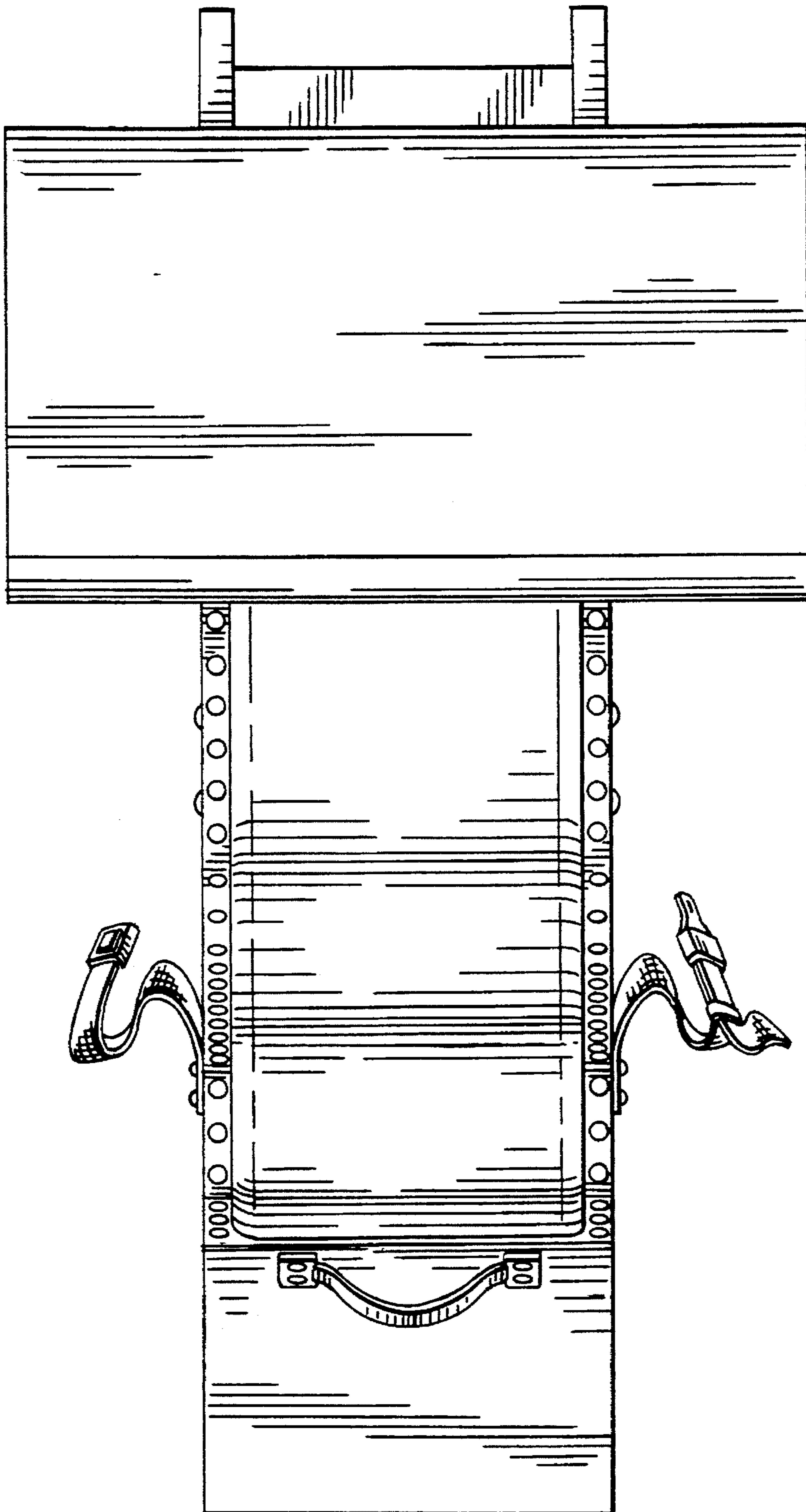

FIG. 4.

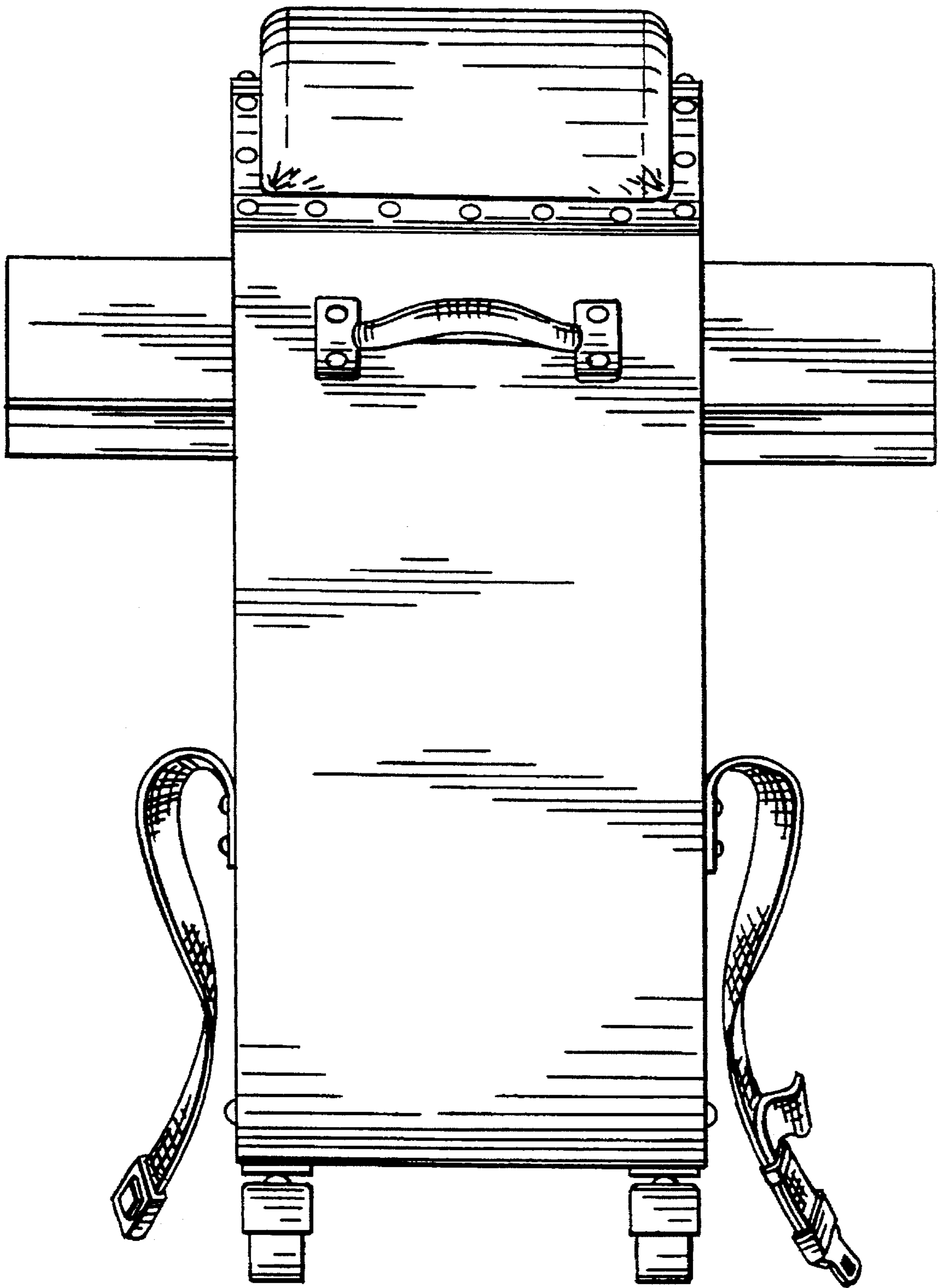

FIG. 5.

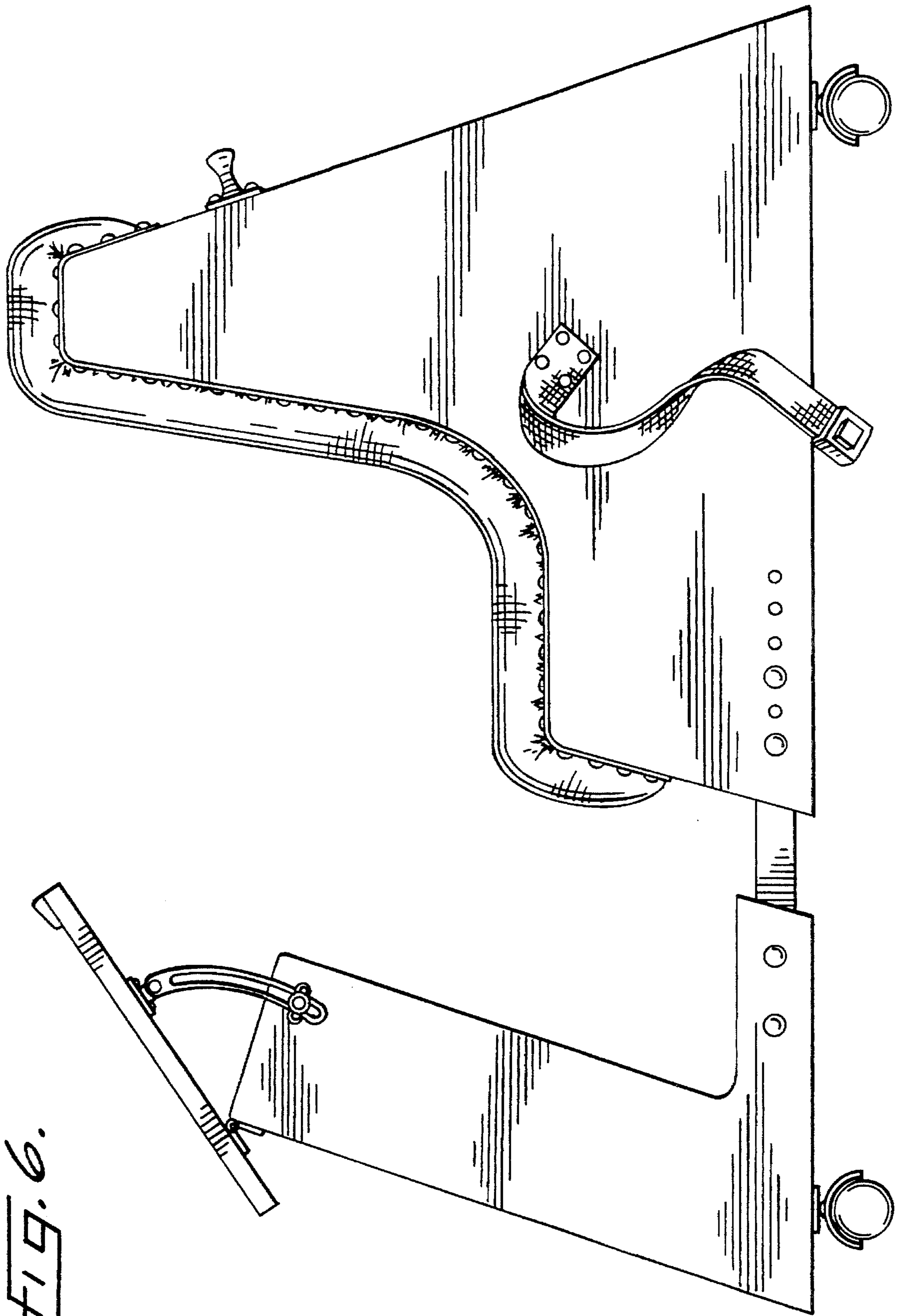

FIG. 6.