



US00D362889S

# United States Patent [19]

[11] Patent Number: **Des. 362,889**

Blough et al.

[45] Date of Patent: **\*\*Oct. 3, 1995**

[54] **GOLF CLUB HEAD**

5,209,473 5/1993 Fisher .

[75] Inventors: **R. Thomas Blough**, Mineral, Va.;  
**Michael E. Finn**, Ft. Worth, Tex.

### OTHER PUBLICATIONS

Golf World; Mar. 4, 1988; p. 19; "Titleist DTR" iron middle right of page.

[73] Assignee: **Ben Hogan Company**, Richmond, Va.

*Primary Examiner*—Terry A. Wallace  
*Assistant Examiner*—Mitchell I. Siegel  
*Attorney, Agent, or Firm*—Martin Smolowitz

[\*\*] Term: **14 Years**

[21] Appl. No.: **28,677**

### [57] CLAIM

[22] Filed: **Sep. 20, 1994**

The ornamental design for a golf club head, as shown and described.

[52] U.S. Cl. .... **D21/220**

[58] Field of Search ..... D21/220; 273/167-175

### [56] References Cited

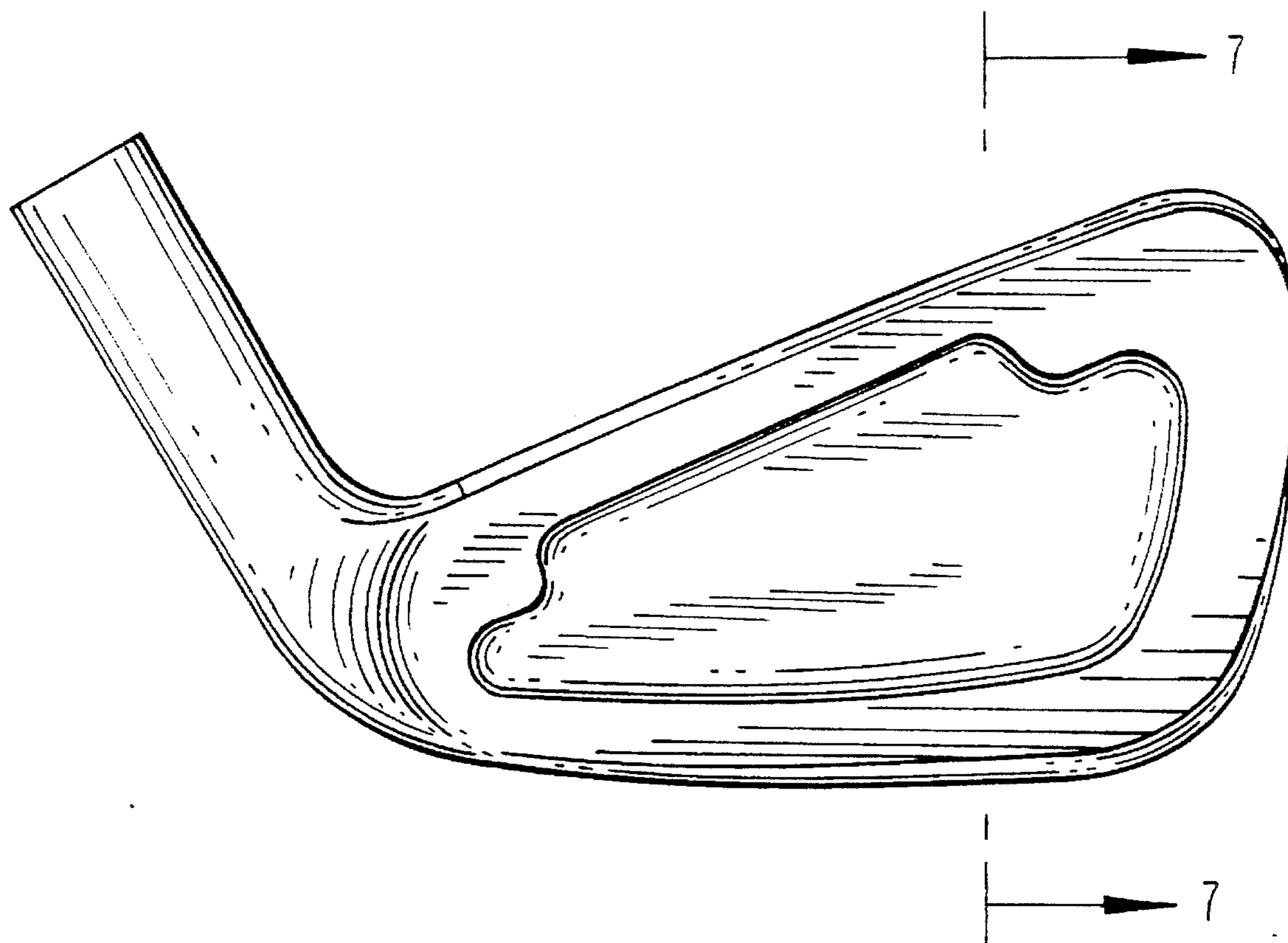
### DESCRIPTION

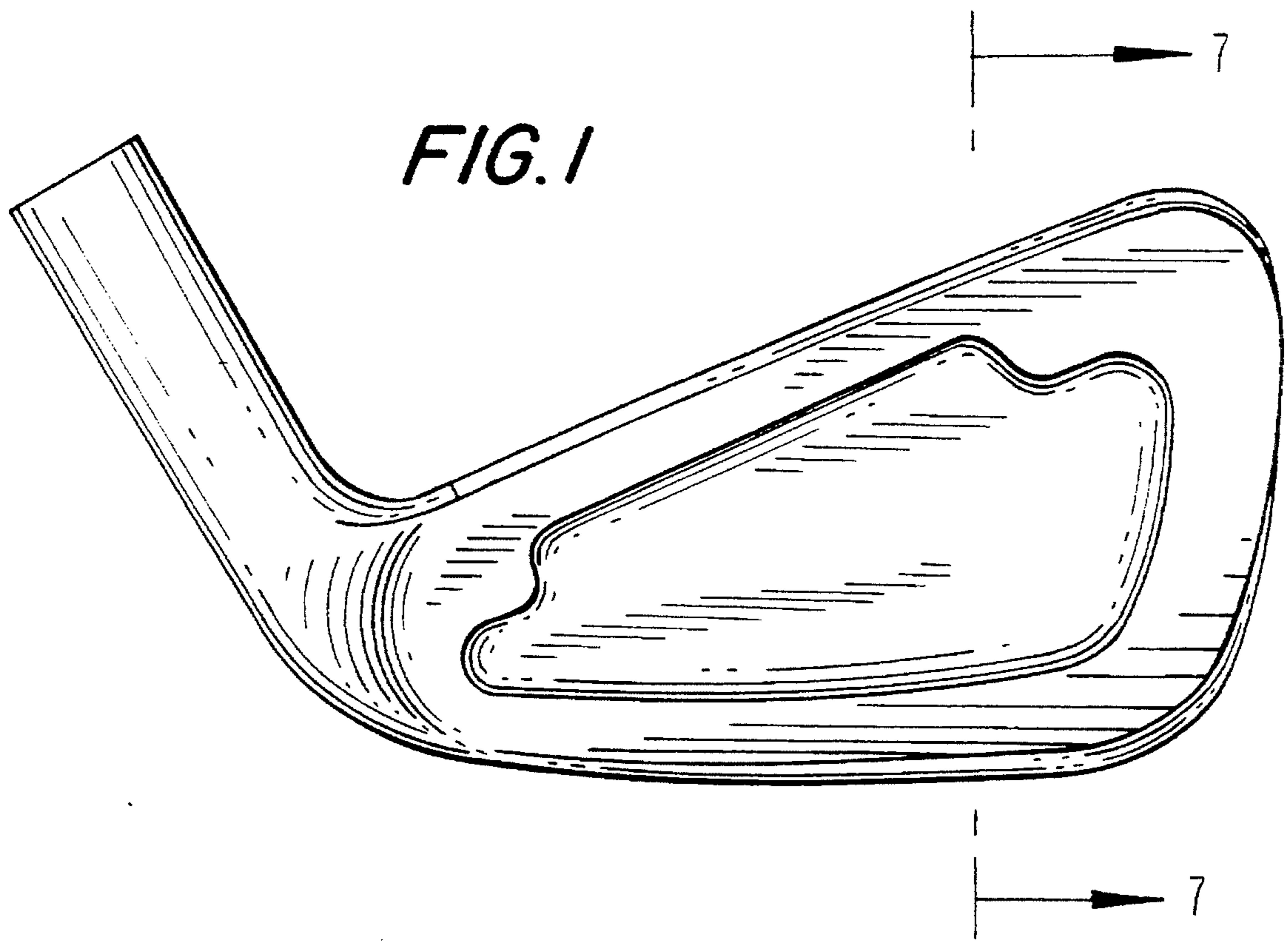
#### U.S. PATENT DOCUMENTS

D. 328,936	8/1992	Antonious .....	D21/220
D. 354,786	1/1995	Manning et al. ....	D21/220
D. 355,234	2/1995	MacNally et al. ....	D21/220
3,059,926	10/1962	Johnstone .	
3,655,188	4/1972	Solheim .	
4,848,747	7/1989	Fujimuta .	
5,011,151	4/1991	Antonious .	
5,026,056	6/1991	McNally .	
5,160,136	11/1992	Eger .	
5,160,137	11/1992	Katayama .	

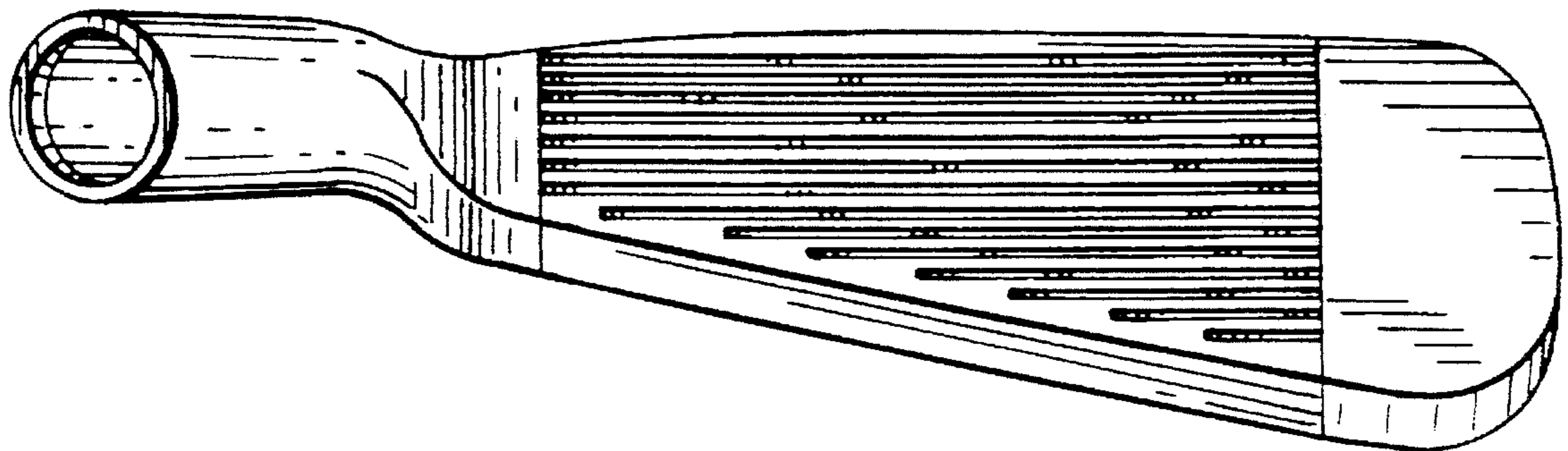
FIG. 1 is a front elevational view of the golf club head showing our new design;  
FIG. 2 is a top plan view thereof;  
FIG. 3 is a right side view thereof;  
FIG. 4 is a left side view thereof;  
FIG. 5 is a bottom plan view thereof;  
FIG. 6 is a rear elevational view thereof; and,  
FIG. 7 is a cross-sectional view taken along lines 7/7 of FIG. 1.

**1 Claim, 3 Drawing Sheets**

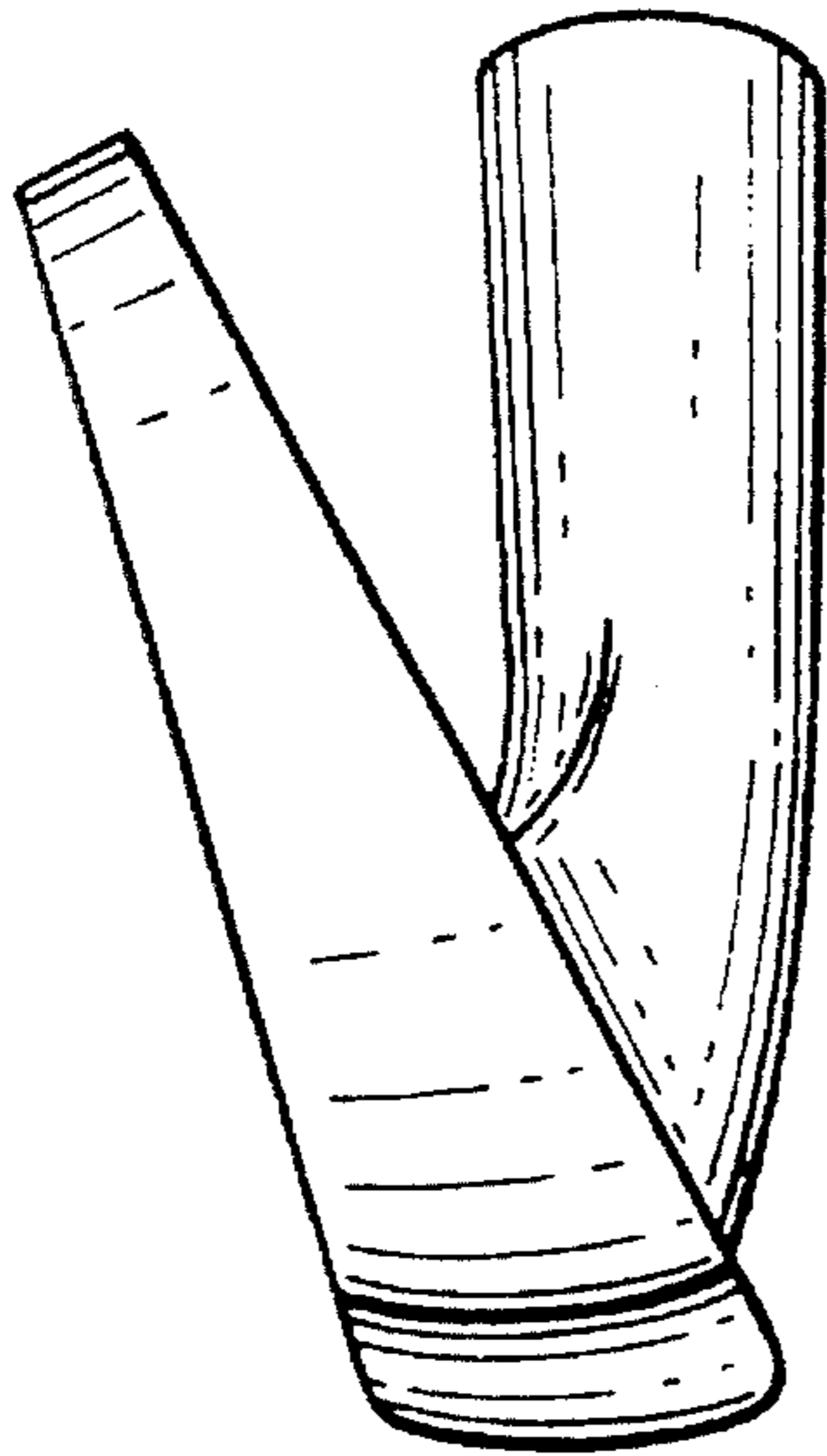




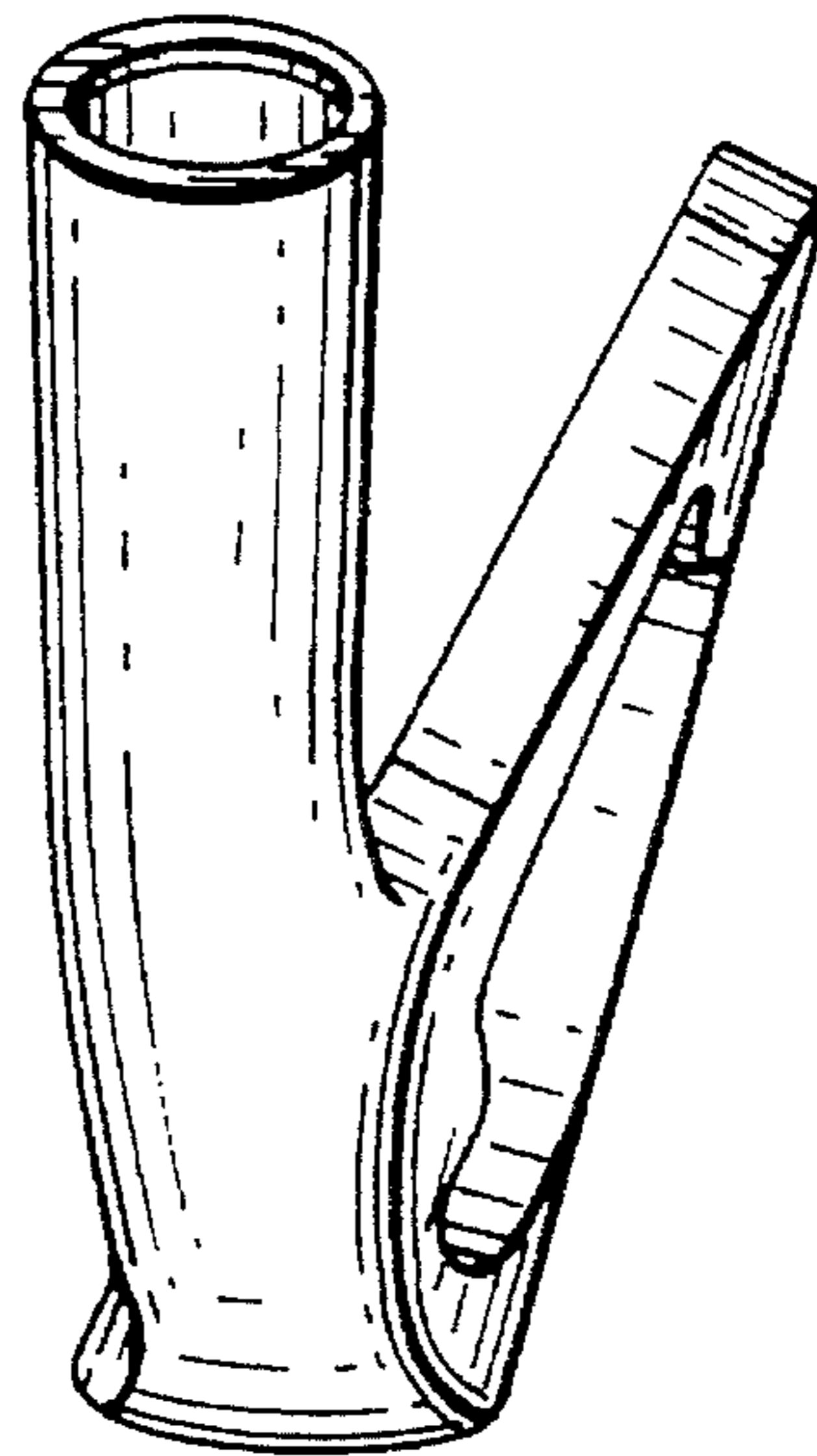
*FIG. 2*



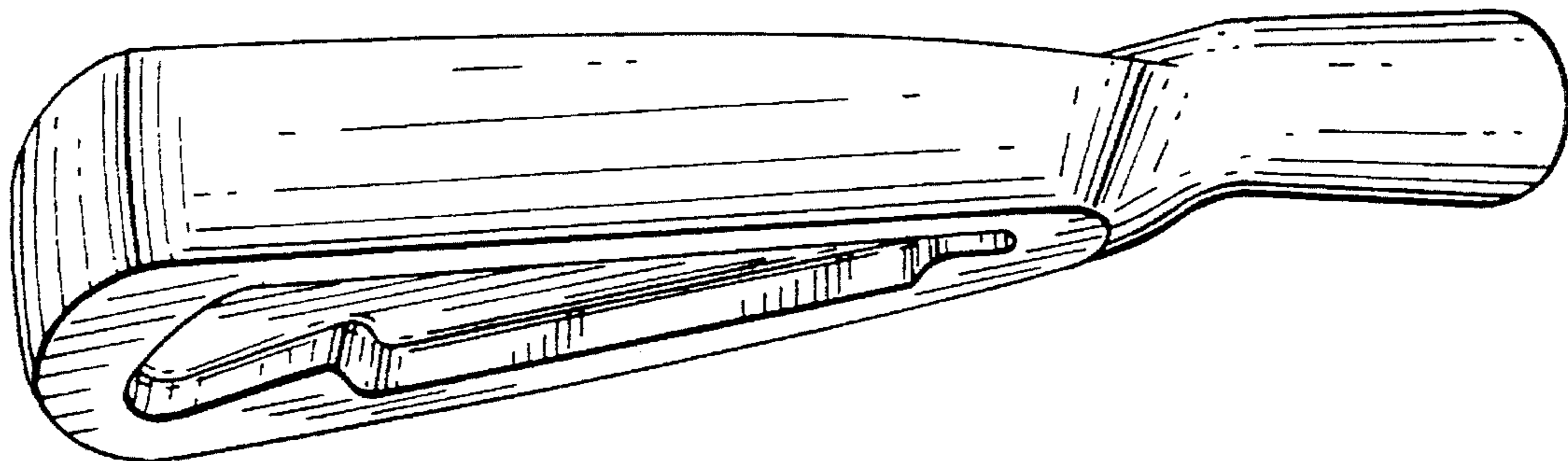
*FIG. 3*



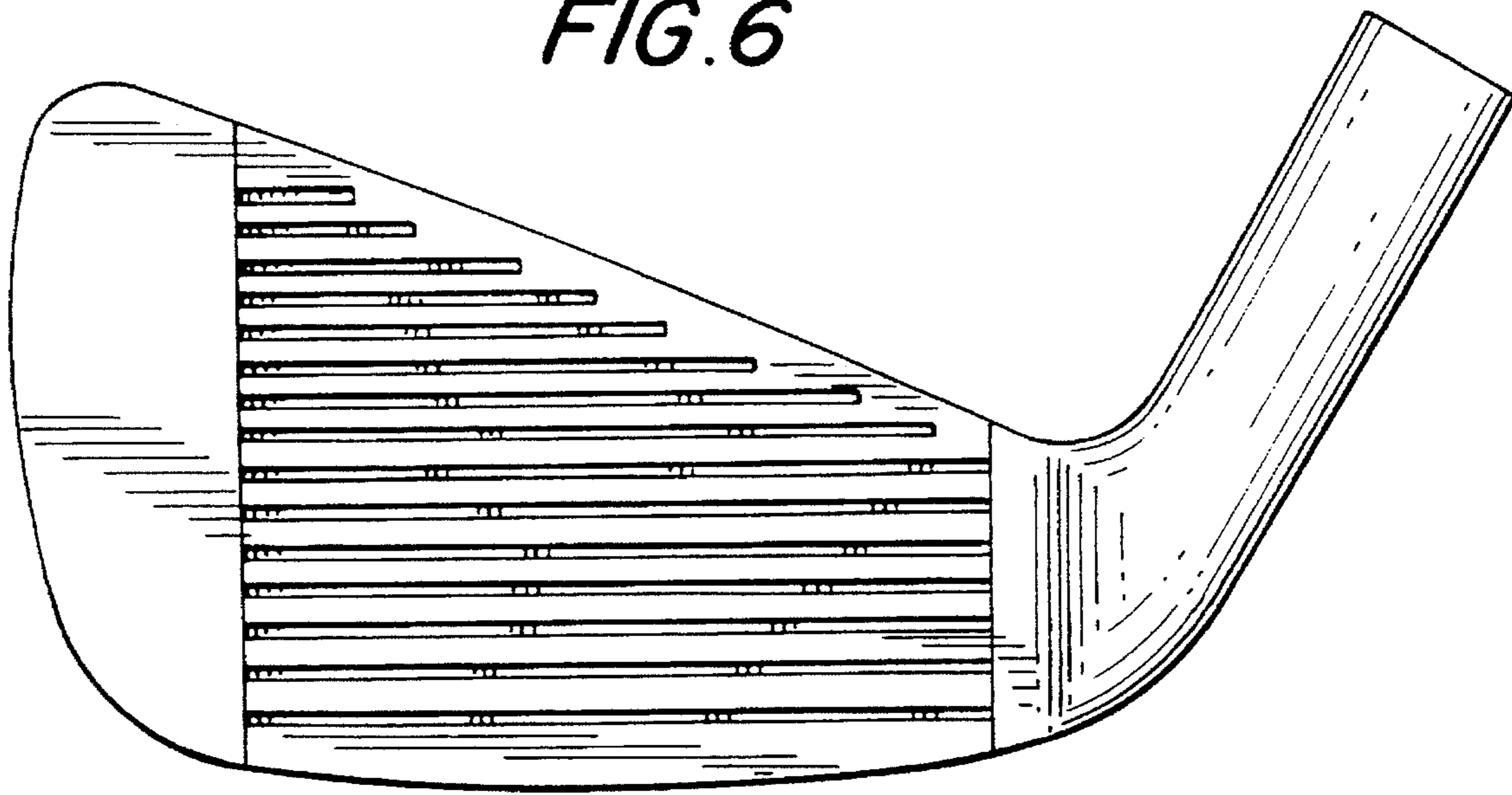
*FIG. 4*



*FIG. 5*



**FIG. 6**



**FIG. 7**

