



US00D362887S

# United States Patent [19]

[11] Patent Number: **Des. 362,887**

Blough et al.

[45] Date of Patent: **\*\*Oct. 3, 1995**

## [54] GOLF CLUB HEAD

[75] Inventors: **R. Thomas Blough**, Mineral, Va.;  
**Eugene L. Sheeley**, Ft. Worth, Tex.

[73] Assignee: **Ben Hogan Company**, Richmond, Va.

[\*\*] Term: **14 Years**

[21] Appl. No.: **28,672**

[22] Filed: **Sep. 20, 1994**

[52] U.S. Cl. .... **D21/220**

[58] Field of Search ..... D21/220; 273/167-175

## [56] References Cited

### U.S. PATENT DOCUMENTS

|            |        |                 |         |
|------------|--------|-----------------|---------|
| D. 141,307 | 5/1945 | Newsome .....   | D21/220 |
| D. 141,769 | 7/1945 | Newsome .       |         |
| D. 203,936 | 3/1966 | Long .          |         |
| D. 300,547 | 4/1989 | Kobayashi ..... | D21/220 |
| D. 329,481 | 9/1992 | Hunt .          |         |
| D. 332,984 | 2/1993 | Iinuma et al .  |         |
| D. 337,143 | 7/1993 | Lo .....        | D21/220 |
| 2,254,528  | 9/1941 | Hoare .         |         |
| 5,048,834  | 9/1991 | Gorman .        |         |

## OTHER PUBLICATIONS

Golf World; Aug. 28, 1987; p. 19; "Ben Hogan " iron, bottom of page.

Northwestern 1976 Catalog; p. 22; "Lady Ultimate" iron, on left of page.

*Primary Examiner*—Terry A. Wallace  
*Assistant Examiner*—Mitchell I. Siegel  
*Attorney, Agent, or Firm*—Martin Smolowitz

## [57] CLAIM

The ornamental design for a golf club head, as shown and described.

## DESCRIPTION

FIG. 1 is a front elevational view of the golf club head showing our new design;  
FIG. 2 is a top plan view thereof;  
FIG. 3 is a right side view thereof;  
FIG. 4 is a left side view thereof;  
FIG. 5 is a bottom plan view thereof;  
FIG. 6 is a rear elevational view thereof; and,  
FIG. 7 is a cross-sectional view taken along lines 7/7 of FIG. 1.

1 Claim, 3 Drawing Sheets

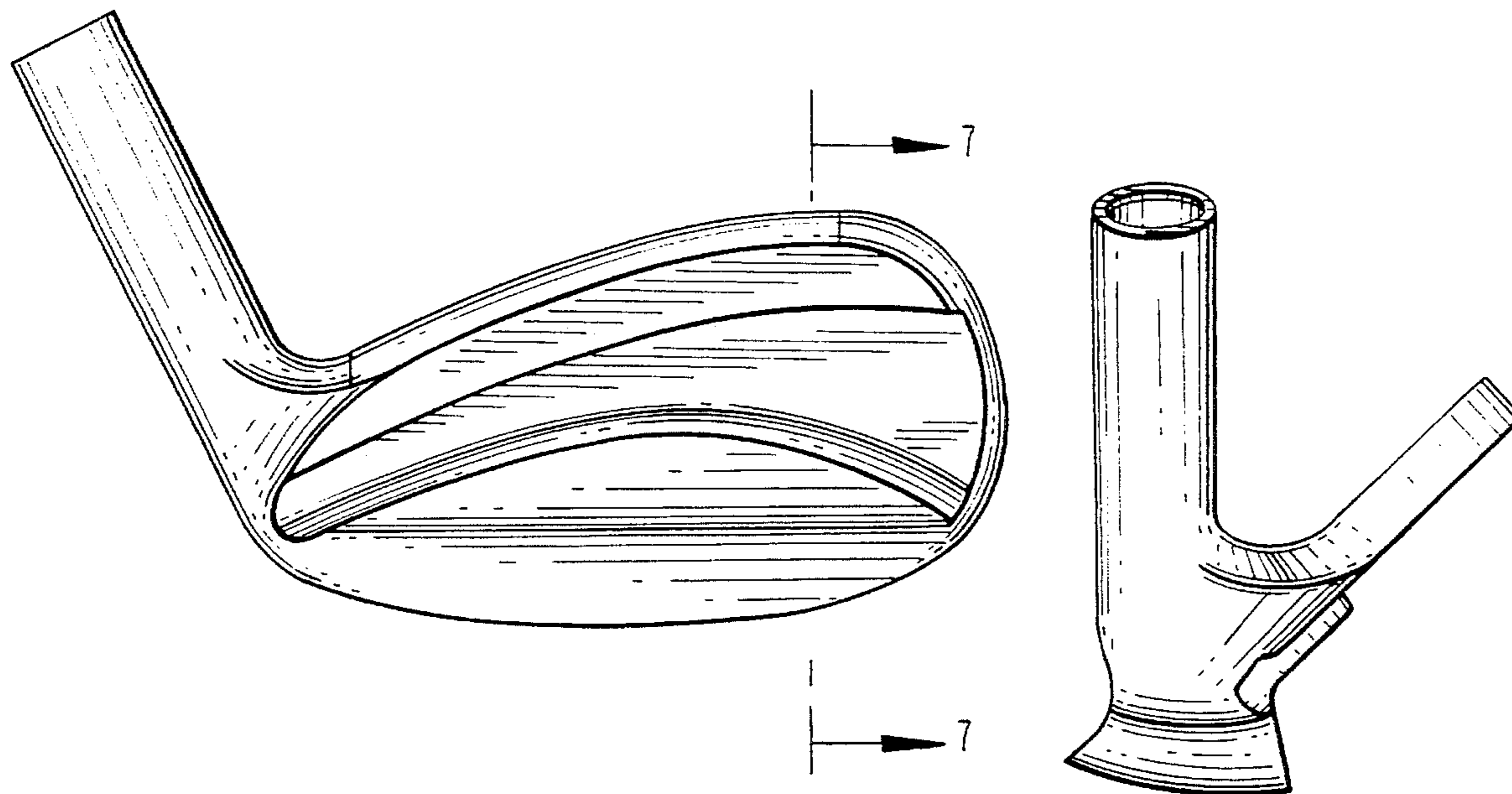

*FIG. 1*

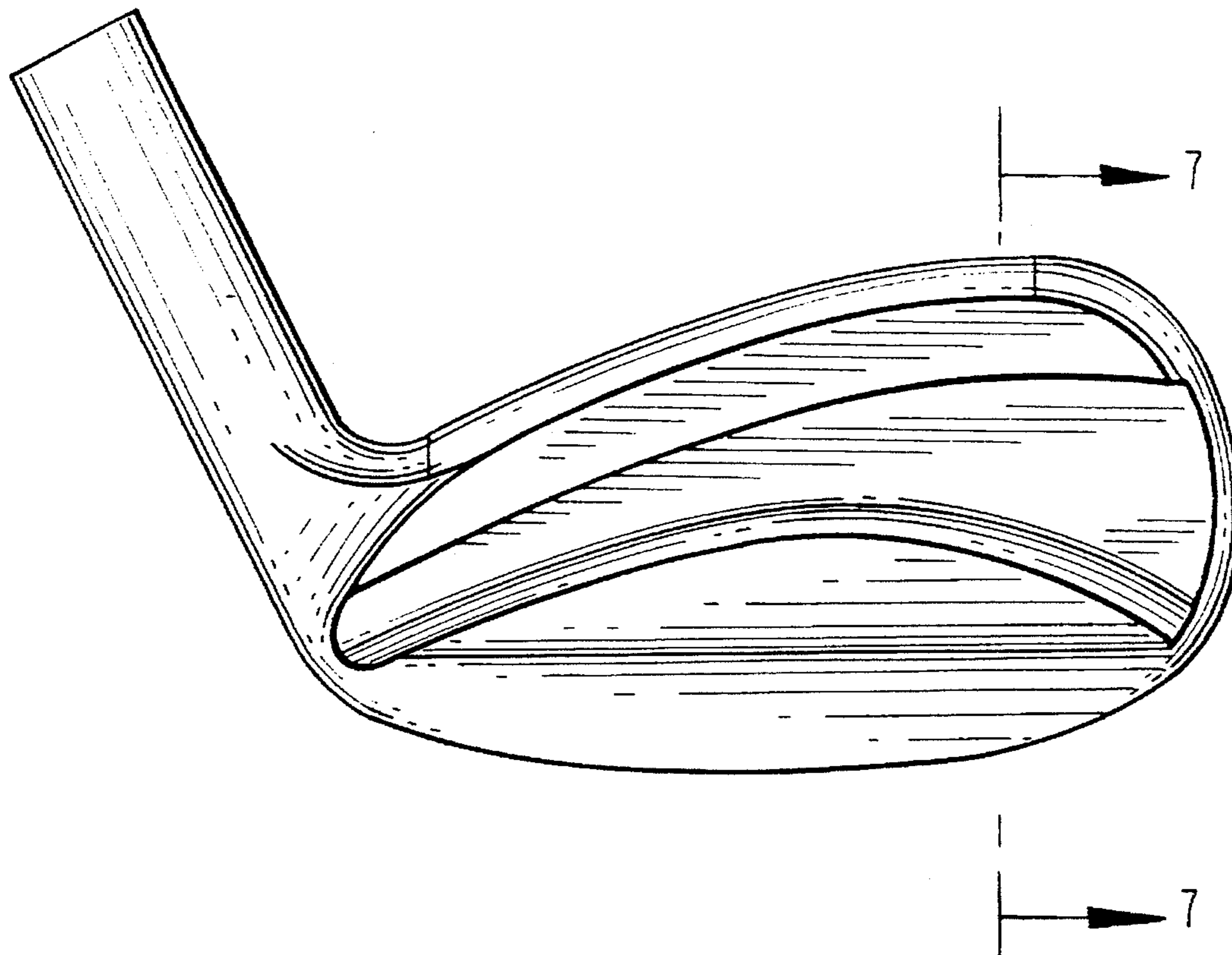

*FIG. 2*

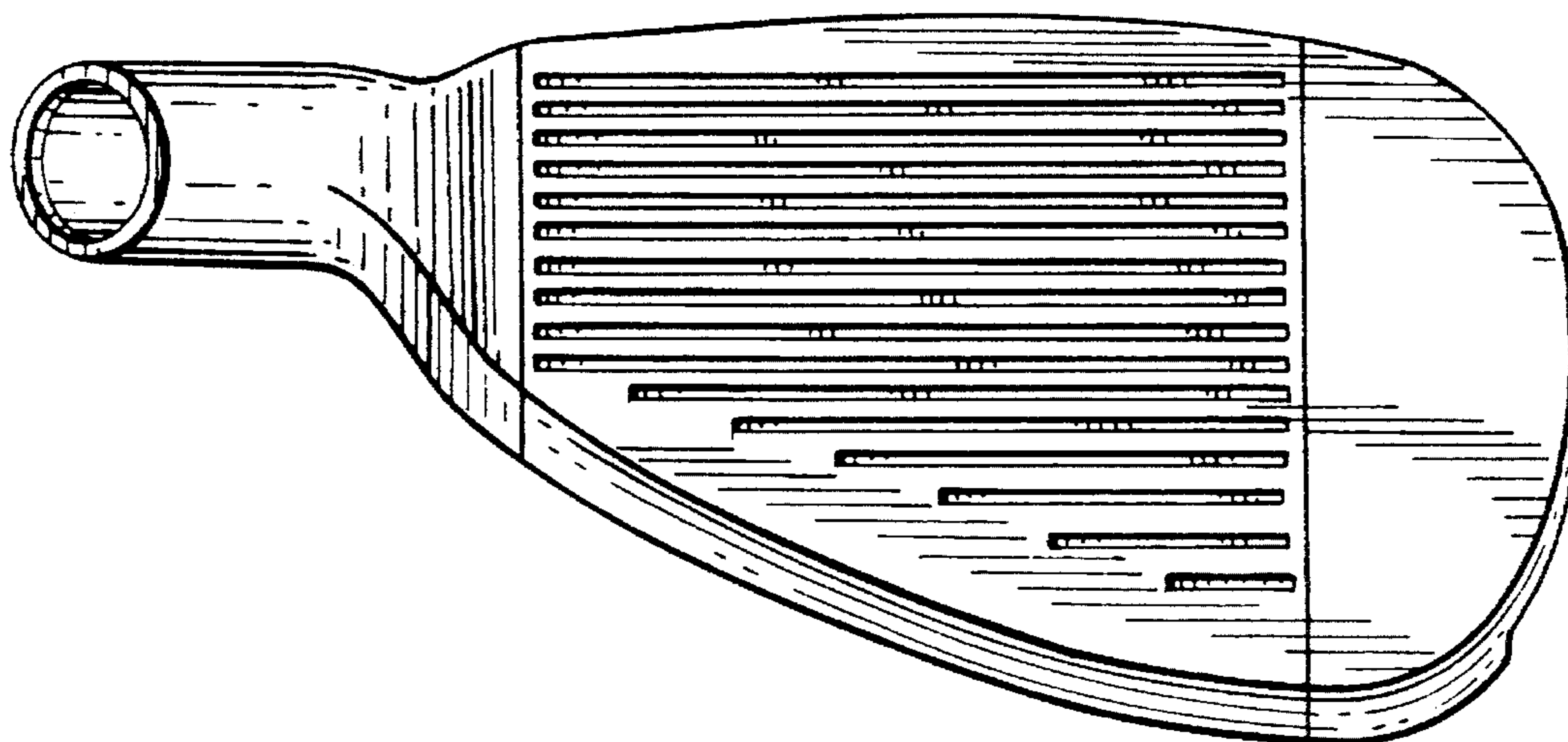

**FIG. 3**

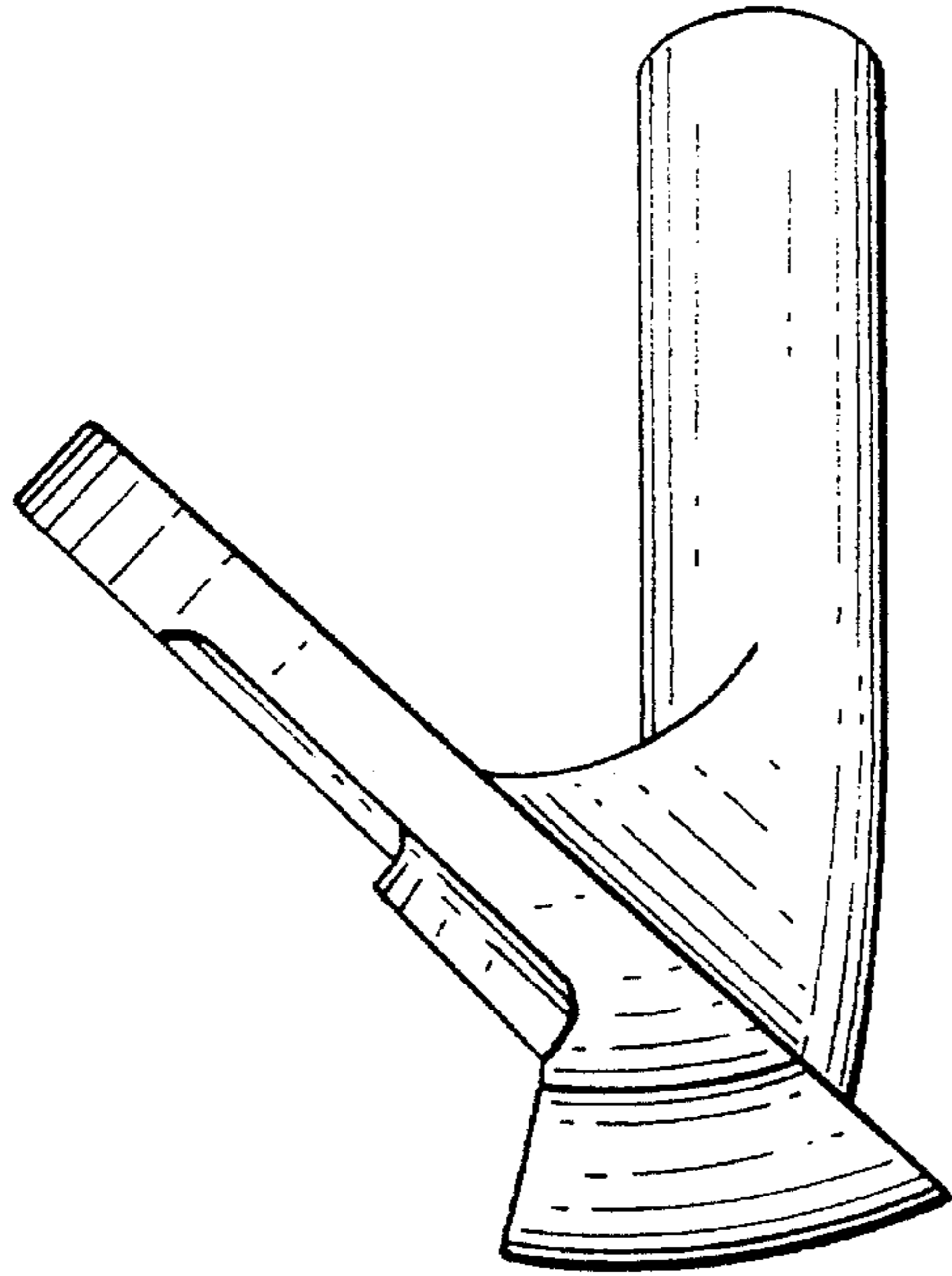

**FIG. 4**

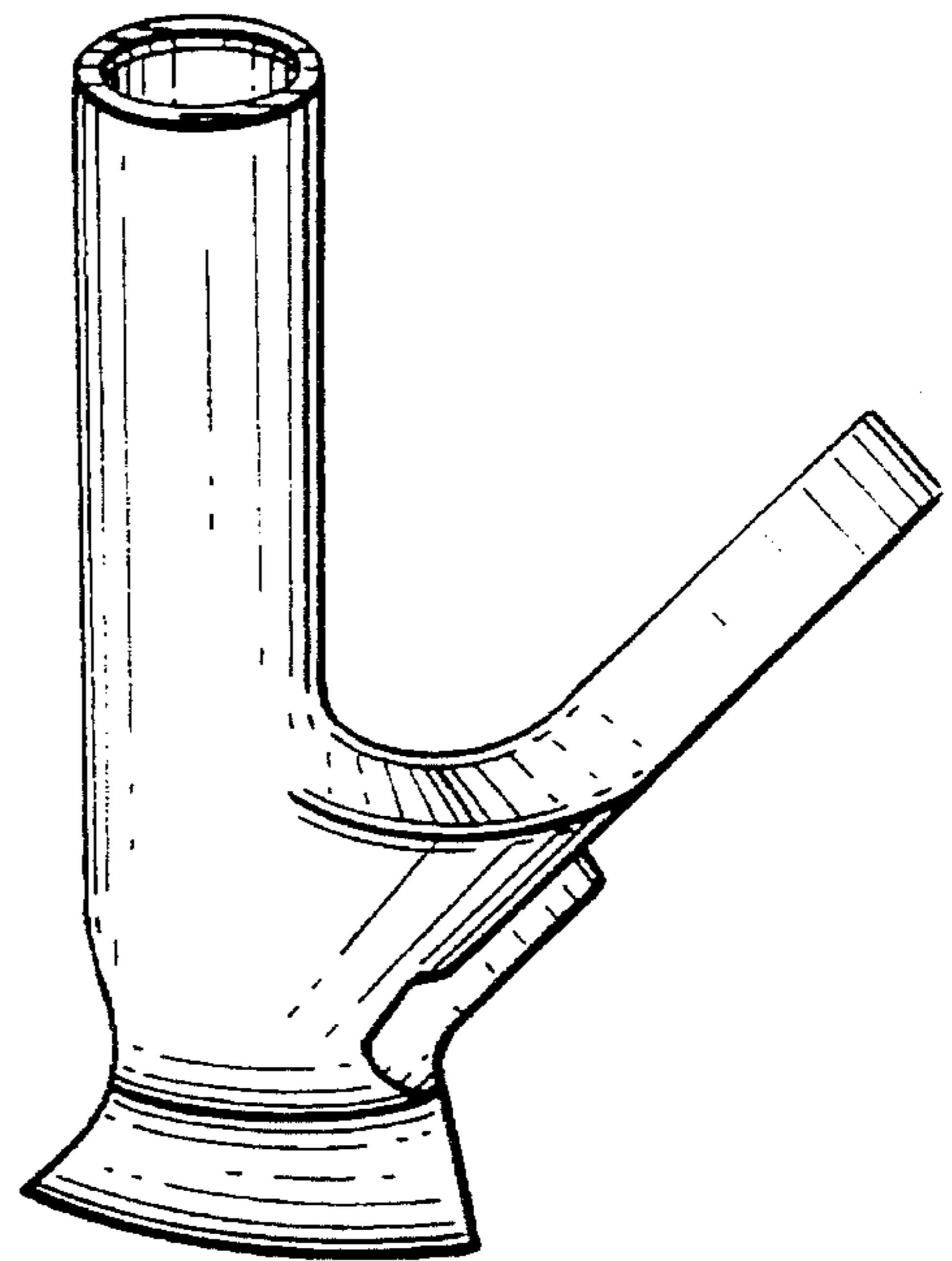

**FIG. 5**

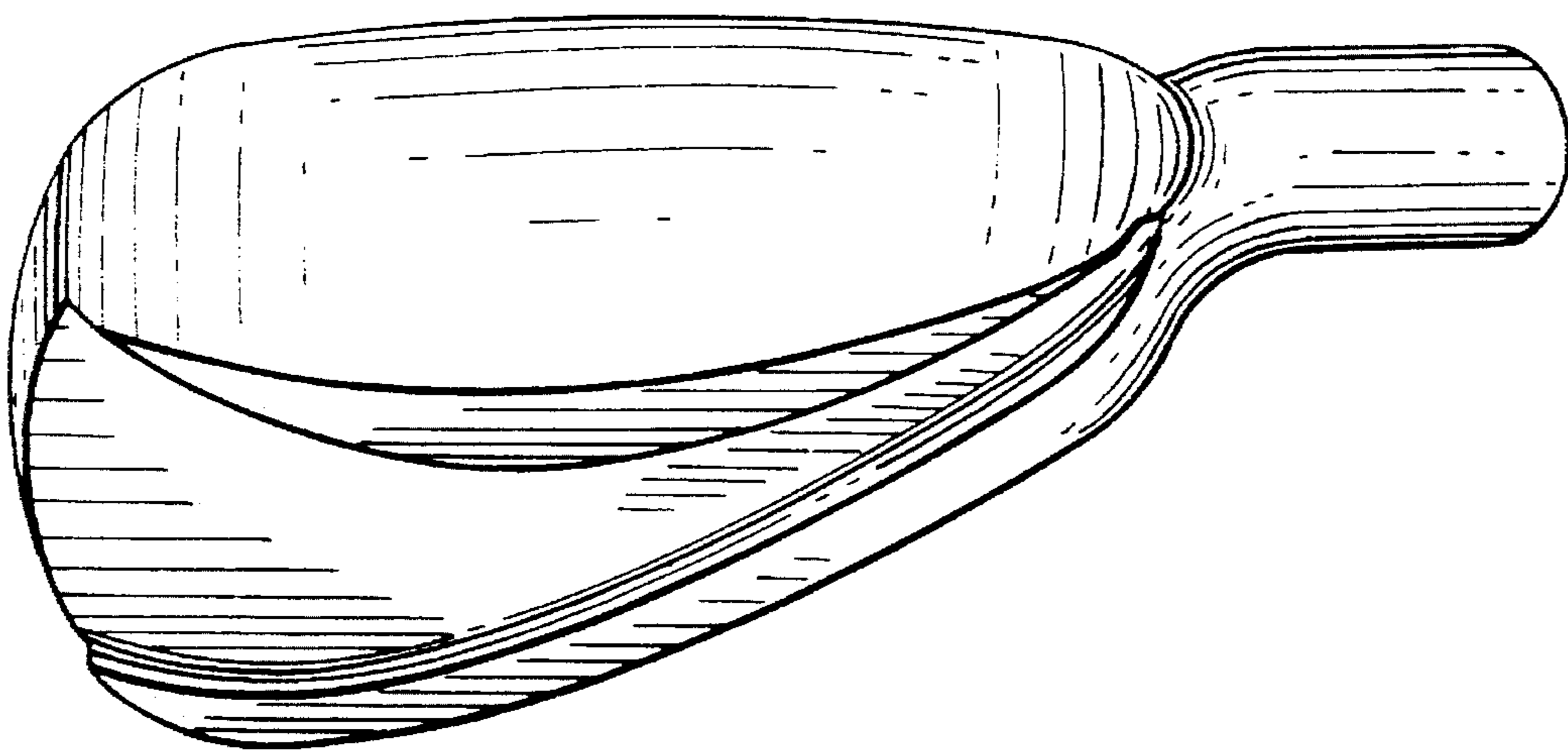

*FIG. 6*

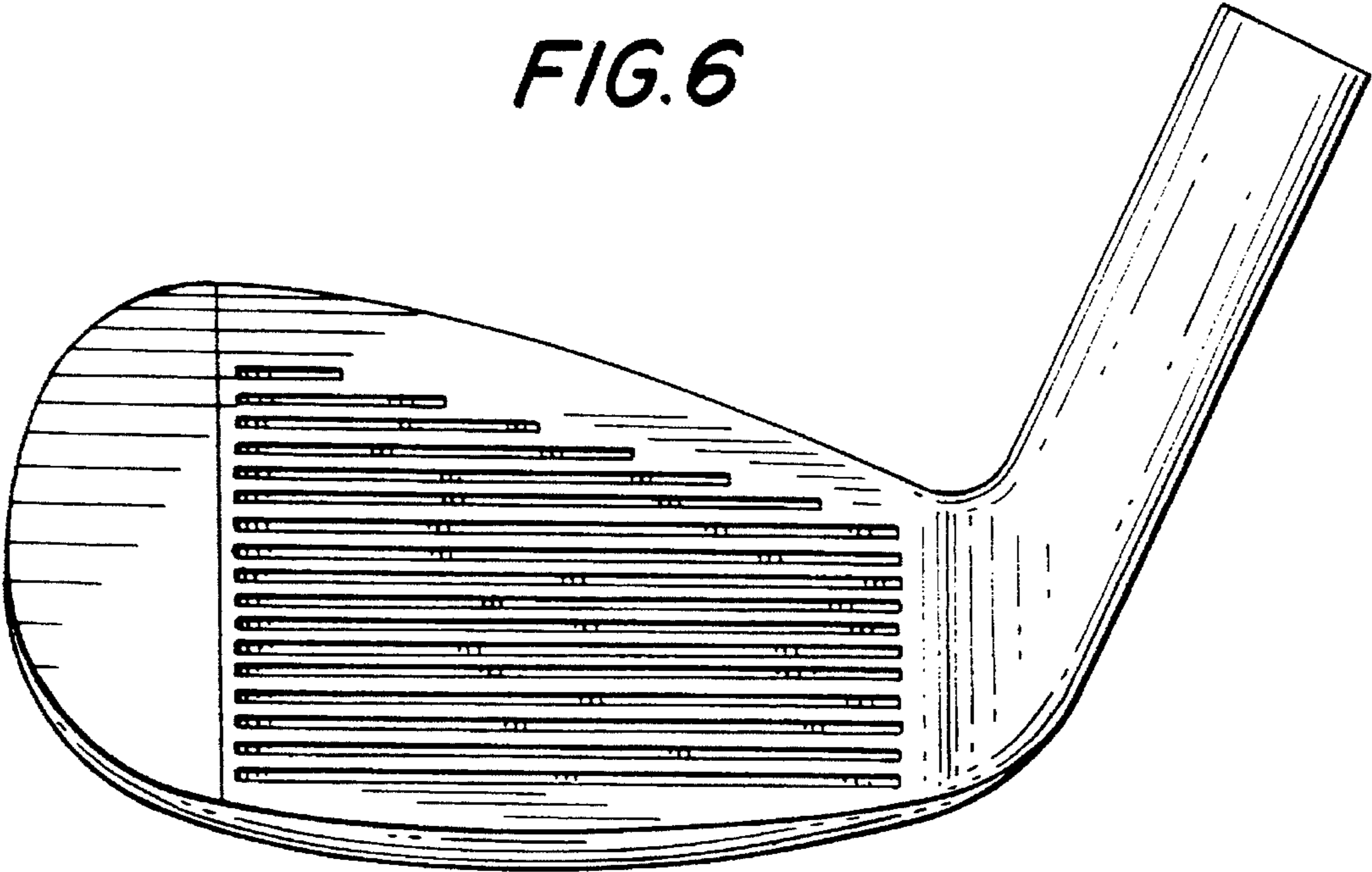

*FIG. 7*

