



US00D362884S

**United States Patent** [19]  
**Blough et al.**

[11] **Patent Number:** **Des. 362,884**  
[45] **Date of Patent:** **\*\*Oct. 3, 1995**

[54] **GOLF CLUB HEAD**

[75] Inventors: **R. Thomas Blough**, Mineral, Va.;  
**Eugene L. Sheeley**, Ft. Worth, Tex.

[73] Assignee: **Ben Hogan Company**, Richmond, Va.

[\*\*] Term: **14 Years**

[21] Appl. No.: **28,668**

[22] Filed: **Sep. 20, 1994**

[52] U.S. Cl. .... **D21/220**

[58] Field of Search ..... **D21/220; 273/167-175**

**References Cited**

**U.S. PATENT DOCUMENTS**

D. 141,307	5/1945	Newsome .....	D21/220
D. 141,769	7/1945	Newsome .	
D. 203,936	3/1966	Long .	
D. 300,547	4/1989	Kabayashi .....	D21/220
D. 329,481	9/1992	Hunt .	
D. 332,984	2/1993	Iinuma et al. .	
D. 337,143	7/1993	Lo .....	D21/220
2,254,528	9/1941	Hoare .	
5,048,834	9/1991	Gorman .	

**OTHER PUBLICATIONS**

Golf World; Aug. 28, 1987; p. 19; "Ben Hogan" iron, bottom of page.

Northwestern 1976 Catalog; p. 22; "Lady Ultimate" iron, on left of page.

*Primary Examiner*—Terry A. Wallace

*Assistant Examiner*—Mitchell I. Siegel

*Attorney, Agent, or Firm*—Martin Smolowitz

[57] **CLAIM**

The ornamental design for a golf club head, as shown and described.

**DESCRIPTION**

FIG. 1 is a front elevational view of the golf club head showing our new design;

FIG. 2 is a top plan view thereof;

FIG. 3 is a right side view thereof;

FIG. 4 is a left side view thereof;

FIG. 5 is a bottom plan view thereof;

FIG. 6 is a rear elevational view thereof; and,

FIG. 7 is a cross-sectional view taken along lines 7/7 of FIG. 1.

**1 Claim, 3 Drawing Sheets**

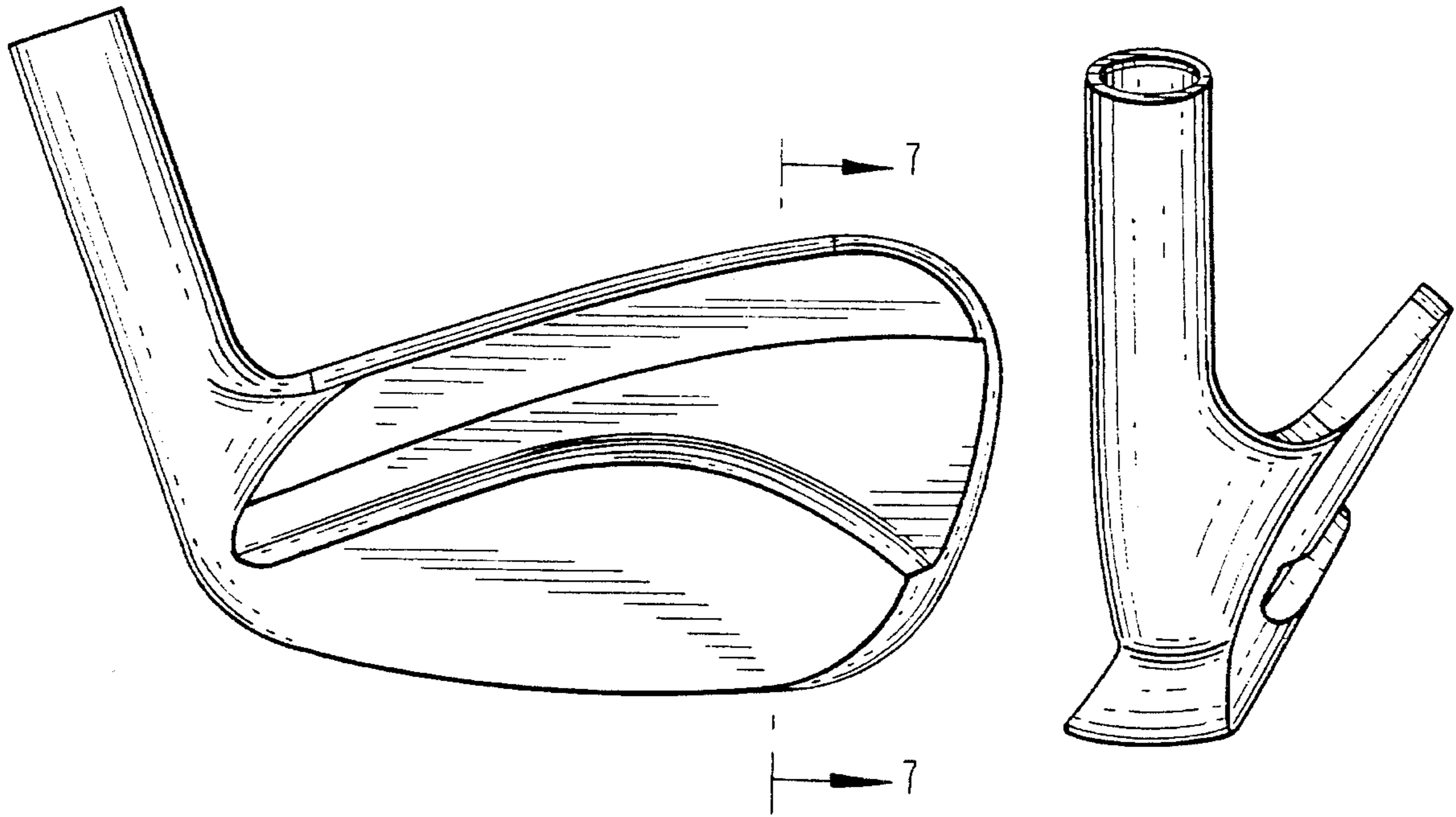

*FIG. 1*

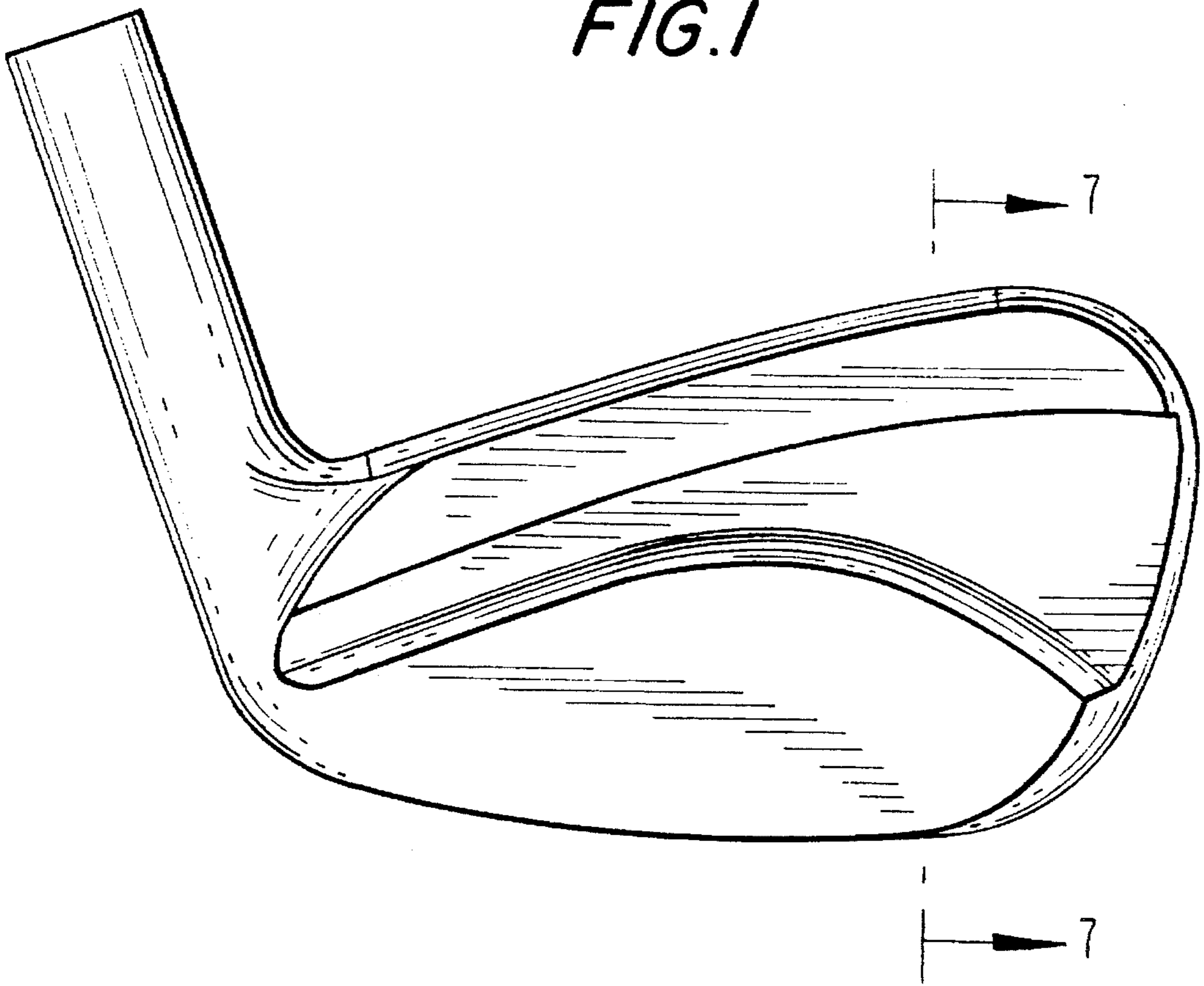

*FIG. 2*

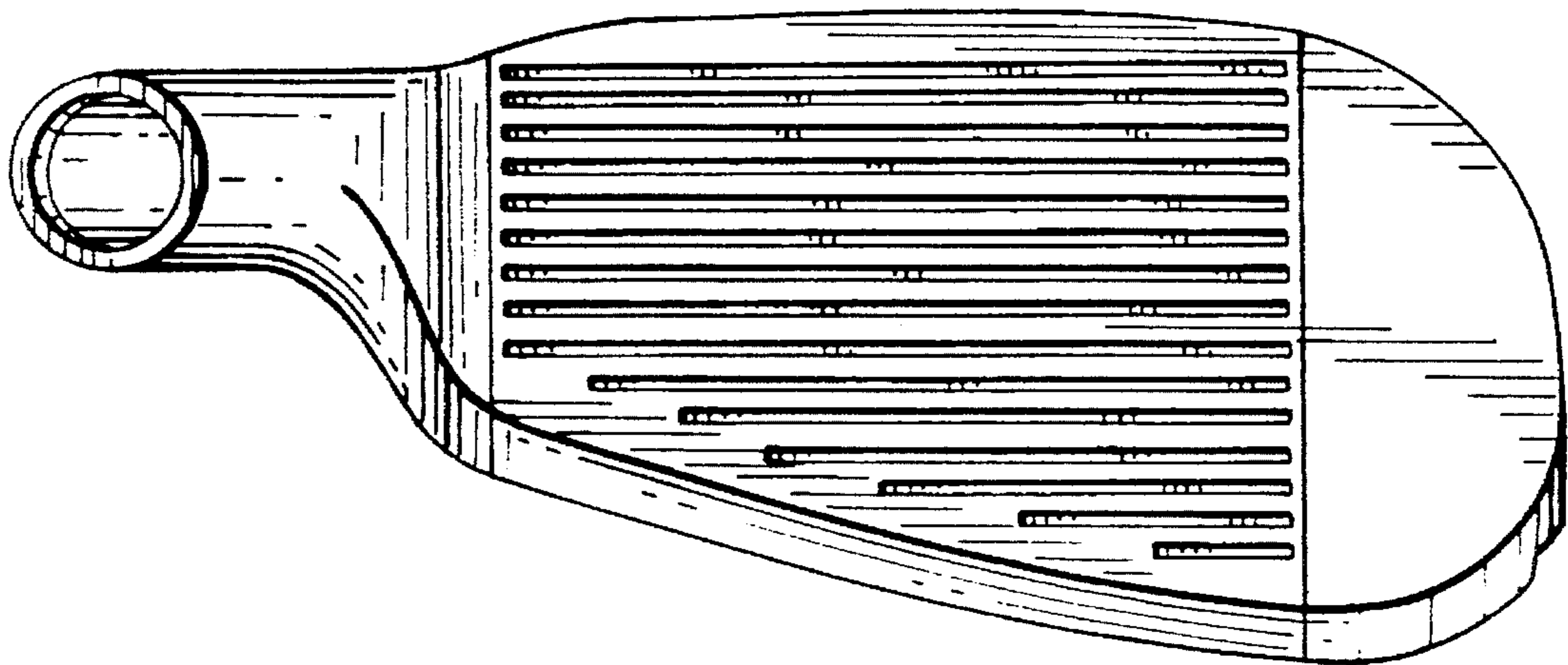

*FIG. 3*

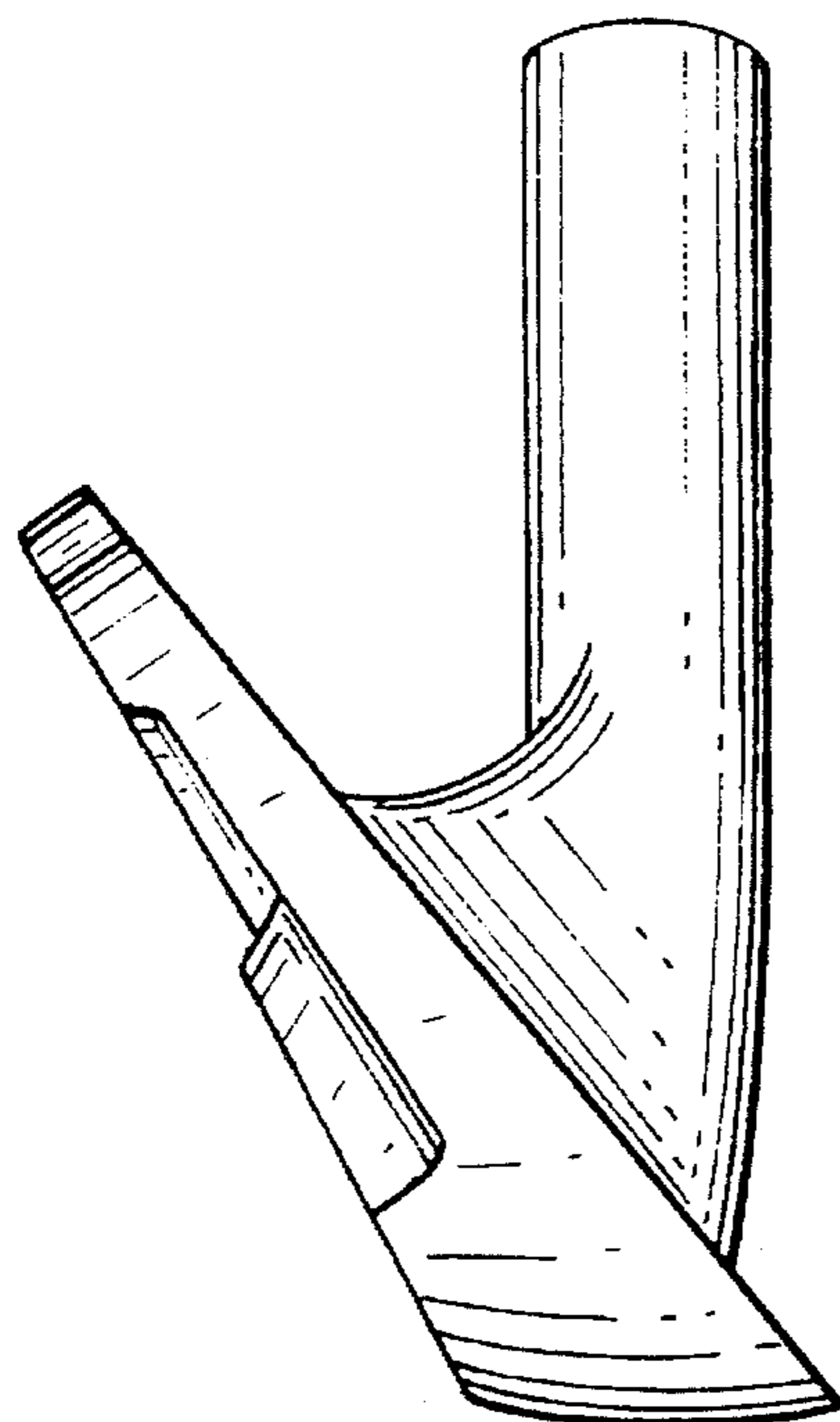

*FIG. 4*

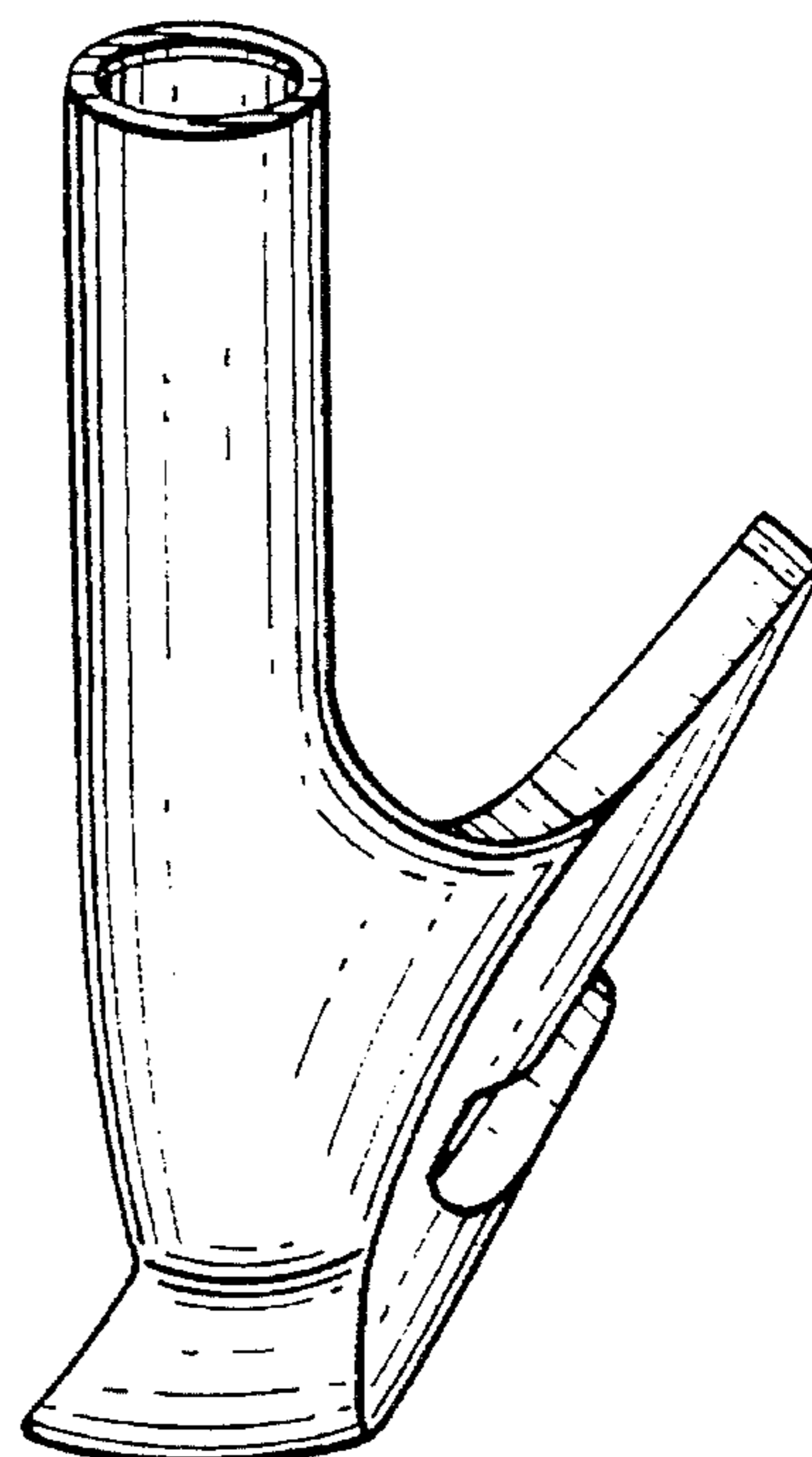

*FIG. 5*

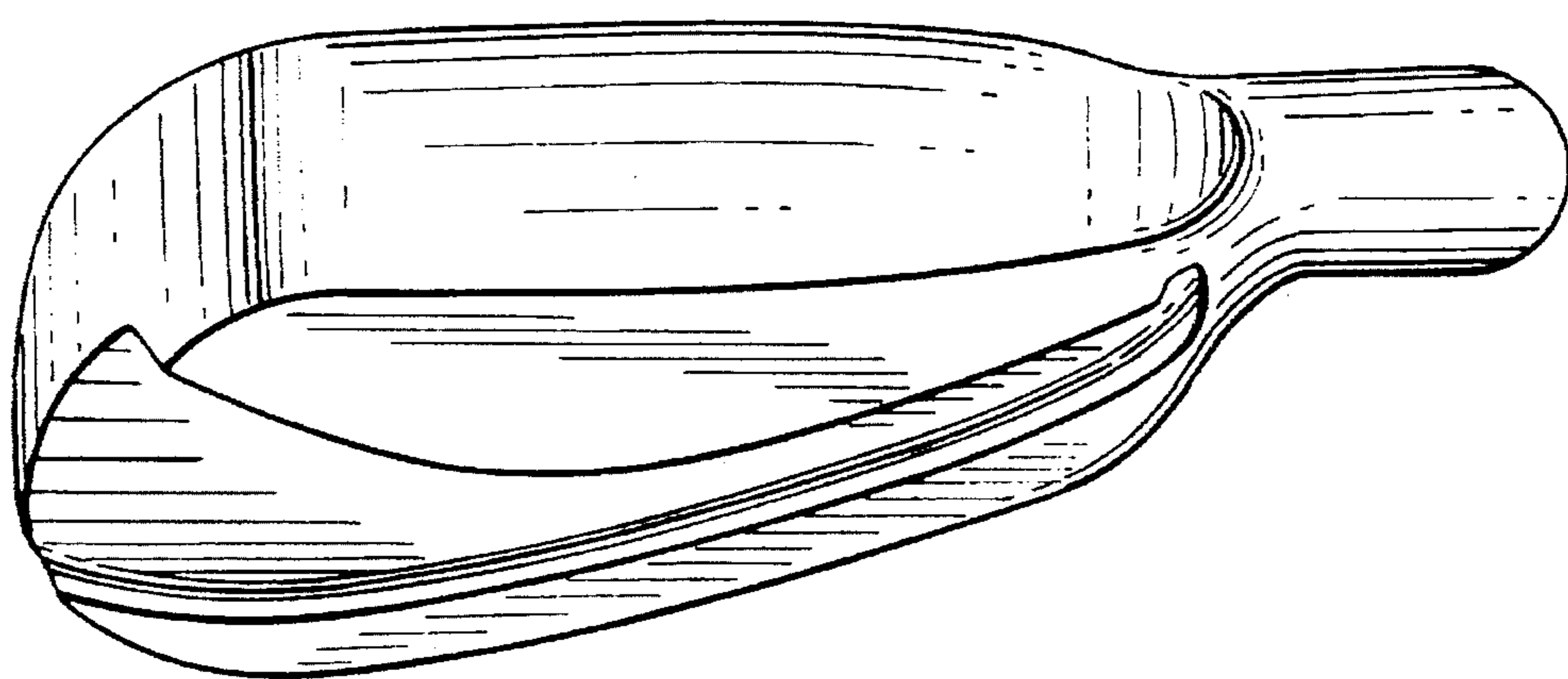

**FIG. 6**

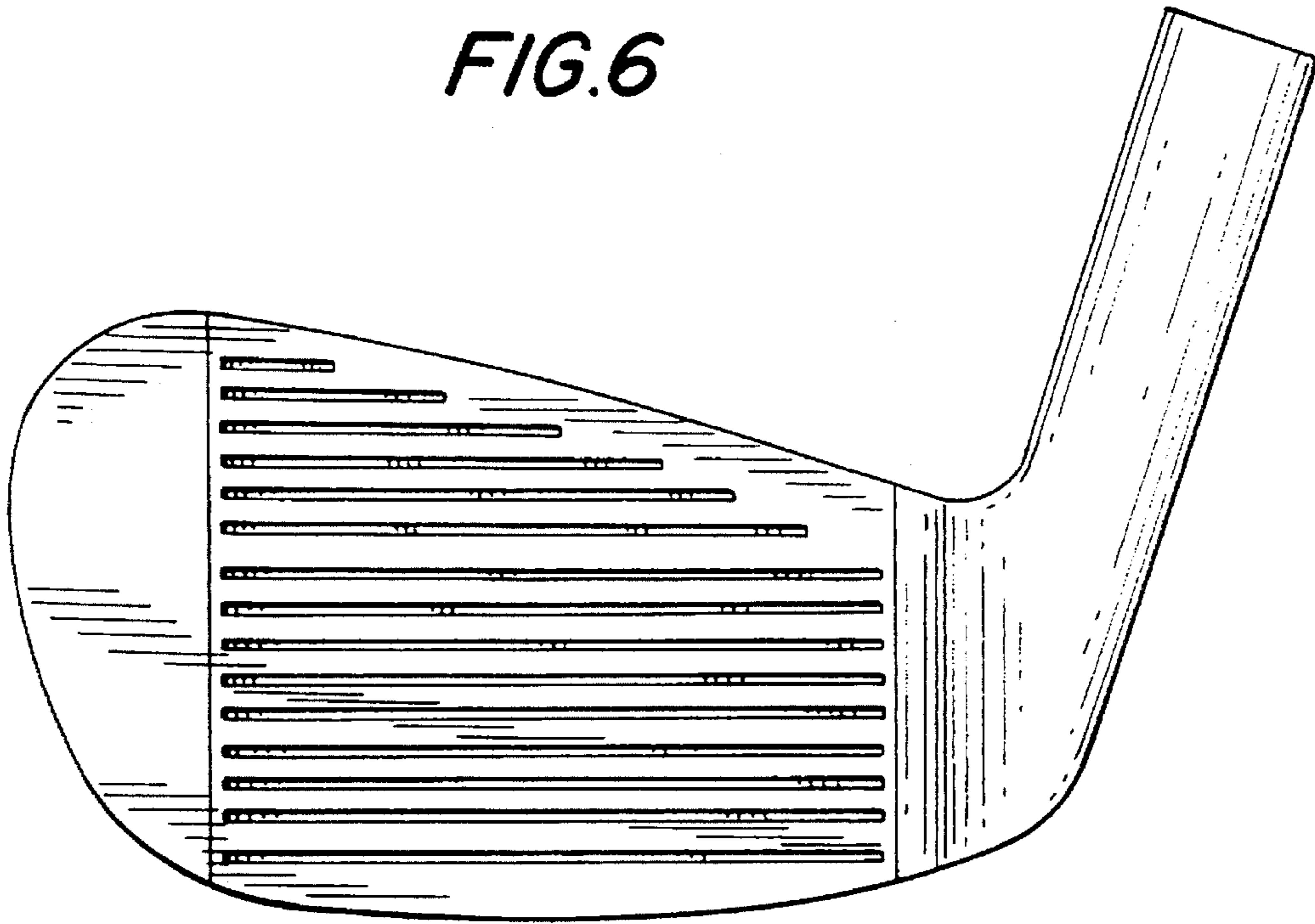

**FIG. 7**

