



US00D362826S

United States Patent [19]

[11] Patent Number: **Des. 362,826**

Weder et al.

[45] Date of Patent: ****Oct. 3, 1995**

[54] FLOWER POT COVER

FOREIGN PATENT DOCUMENTS

[75] Inventors: **Donald E. Weder; Joseph G. Straeter**, both of Highland, Ill.

103316 3/1938 Australia 229/922
560532 4/1975 Switzerland .

[73] Assignee: **Highland Supply Corporation**, Highland, Ill.

OTHER PUBLICATIONS

[**] Term: **14 Years**

Exhibit A—Speed Cover® Brochure—The Simple Solution . . . , ©1989.

[21] Appl. No.: **808,567**

Exhibit F. Photo of pot cover made by a Holland Company (K.P.I.). Date of first public use believed to be late 1984.

[22] Filed: **Dec. 16, 1991**

Exhibit G. "The Glass of Frederick Carder", copyright 1971 by P. V. Gardner, showing various styles of glass basket-like vases or containers.

Related U.S. Application Data

(List continued on next page.)

[63] Continuation-in-part of Ser. No. 710,272, Jun. 4, 1991, which is a continuation-in-part of Ser. No. 617,454, Nov. 21, 1990, abandoned, and a continuation-in-part of Ser. No. 411,249, Sep. 22, 1989, and a continuation-in-part of Ser. No. 411,247, Sep. 22, 1989, and a continuation-in-part of Ser. No. 411,245, Sep. 22, 1989.

Primary Examiner—Jeffrey Asch
Attorney, Agent, or Firm—Dunlap & Coddling

[52] U.S. Cl. **D11/164; D11/143**

[57] CLAIM

[58] Field of Search D11/143, 164, D11/152–156; 47/66, 72; 206/423; 215/100.5; 229/1.5 B, 108, 4.5, 108.1, 122, 109, 110; 428/27, 35.1, 542.6, 24; D19/96; D7/540, 584, 586, 587, 354

The ornamental design for a flower pot cover, as shown and described.

DESCRIPTION

[56] References Cited

U.S. PATENT DOCUMENTS

D. 47,800	9/1915	Pick .	
D. 132,559	5/1942	Sawyer	D11/153
D. 209,788	11/1978	Affel .	
D. 254,659	4/1980	Karotseris	D11/143
D. 287,950	1/1987	Weder et al.	D11/143
D. 289,024	3/1987	Vaughn	D11/164
D. 289,982	5/1987	Weder et al.	D11/164
D. 292,182	10/1987	Weder et al.	D11/164
D. 292,183	10/1987	Weder et al.	D11/164
D. 292,184	10/1987	Weder et al.	D11/164
D. 292,185	10/1987	Weder et al.	D11/164
D. 292,186	10/1987	Weder et al.	D11/164
D. 292,187	10/1987	Weder et al.	D11/164
D. 292,188	10/1987	Weder et al.	D11/164
D. 292,189	10/1987	Weder et al.	D11/164

FIG. 1 is a perspective view of our new flower pot cover design;
FIG. 2 is a side elevational view thereof;
FIG. 3 is a top plan view thereof;
FIG. 4 is a bottom plan view thereof;
FIG. 5 is a side elevational view of the design of FIG. 1, the only difference being the angle of the skirt;
FIG. 6 is a side elevational view of the design of FIG. 1, the only difference being the angle of the skirt;
FIG. 7 is a top plan view of a second embodiment of the design of FIG. 1, the only difference being the size of the skirt;
FIG. 8 is a top plan view of a third embodiment of the design of FIG. 1, the only difference being the size of the skirt;
FIG. 9 is a side elevational view of a fourth embodiment of the design of FIG. 1, the only difference being the height; and,
FIG. 10 is a side elevational view of a fifth embodiment of the design of FIG. 1, the only difference being the height.
The flower pot cover has no substantial thickness.

(List continued on next page.)

1 Claim, 2 Drawing Sheets

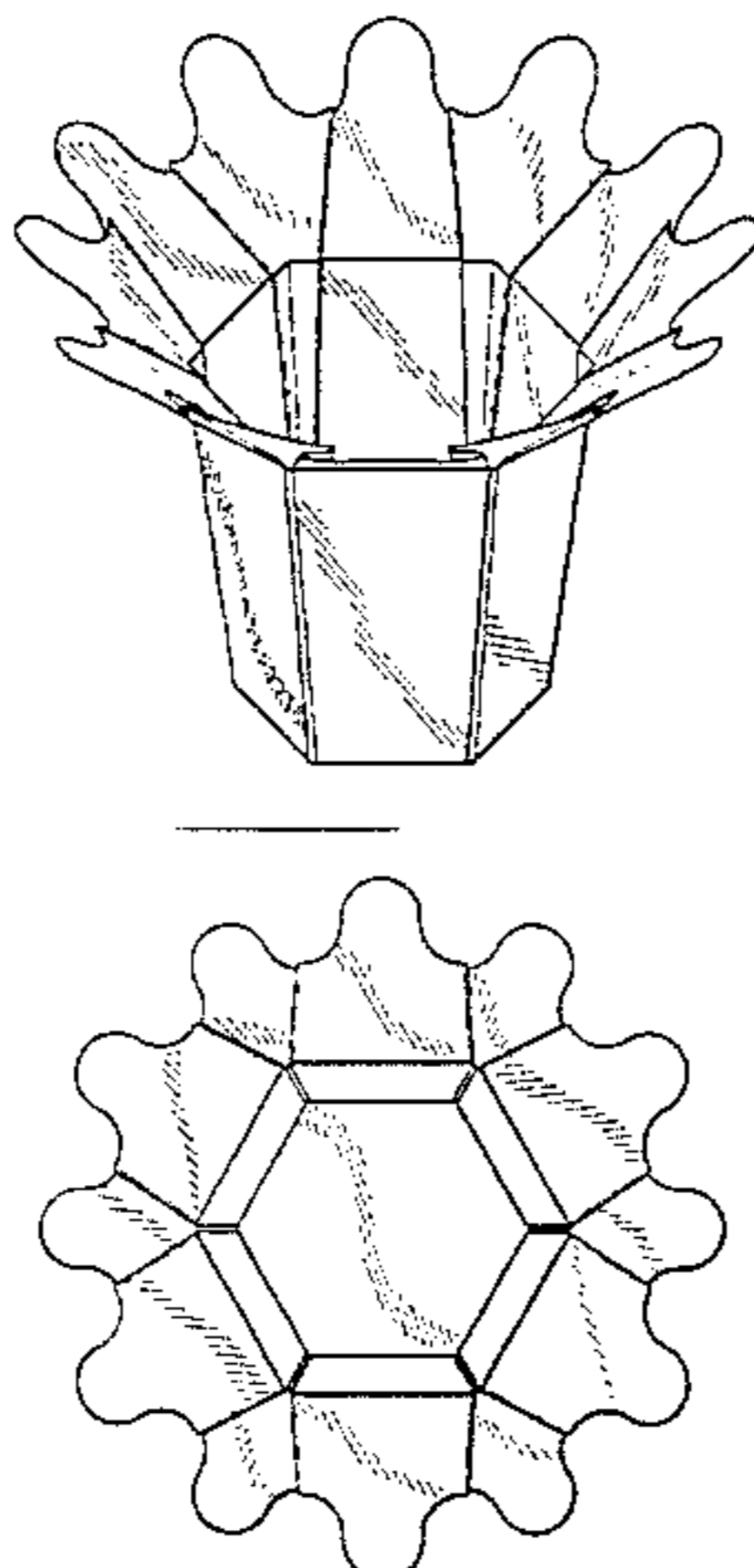

U.S. PATENT DOCUMENTS

D. 292,190	10/1987	Weder et al.	D11/164
D. 292,191	10/1987	Weder et al.	D11/164
D. 292,561	11/1987	Weder et al.	D11/164
D. 292,562	11/1987	Weder et al.	D11/164
D. 292,563	11/1987	Weder et al.	D11/164
D. 293,222	12/1987	Weder et al.	D11/164
D. 293,223	12/1987	Weder et al.	D11/164
D. 293,224	12/1987	Weder et al.	D11/164
D. 293,304	12/1987	Weder et al.	D11/164
D. 293,305	12/1987	Weder et al.	D11/164
D. 293,306	12/1987	Weder et al.	D11/164
D. 293,307	12/1987	Weder et al.	D11/164
D. 293,308	12/1987	Weder et al.	D11/164
D. 293,774	1/1988	Weder et al.	D11/164
D. 293,775	1/1988	Weder et al.	D11/164
D. 296,535	7/1988	Weder et al.	D11/149
D. 297,422	8/1988	Weder et al.	D11/164
D. 298,017	10/1988	Weder et al.	D11/164
D. 301,565	6/1989	Weder	D11/152
D. 302,139	7/1989	Weder	D11/153
D. 302,253	7/1989	Weder	D11/153
D. 302,254	7/1989	Weder	D11/153
D. 302,404	7/1989	Weder	D11/153
D. 302,405	7/1989	Weder	D11/155
D. 302,406	7/1989	Weder	D11/155
D. 302,407	7/1989	Weder	D11/155
D. 303,759	10/1989	Mileos	D9/306
D. 303,775	10/1989	Weder	D11/155
D. 313,376	1/1991	Weder	D11/164
D. 313,573	1/1991	Weder et al.	D11/164
D. 313,574	1/1991	Weder et al.	D11/164
D. 313,575	1/1991	Weder et al.	D11/164
D. 313,576	1/1991	Weder	D11/164
D. 314,732	2/1991	Weder	D11/164
D. 315,534	3/1991	Weder et al.	D11/164
D. 315,878	4/1991	Weder et al.	D11/164
D. 315,879	4/1991	Weder et al.	D11/164
D. 315,880	4/1991	Weder et al.	D11/164
D. 315,881	4/1991	Weder et al.	D11/164
D. 315,882	4/1991	Weder	D11/164
D. 315,883	4/1991	Weder	D11/164
D. 316,060	4/1991	Weder	D11/164
D. 316,061	4/1991	Weder	D11/164
D. 316,062	4/1991	Weder et al.	D11/164
D. 316,837	5/1991	Weder et al.	D11/164
D. 316,838	5/1991	Weder et al.	D11/164
D. 316,985	5/1991	Weder	D11/164
D. 317,424	6/1991	Weder	D11/164
D. 317,582	6/1991	Weder	D11/164
D. 317,583	6/1991	Weder et al.	D11/164
D. 318,029	7/1991	Weder	D11/164
D. 318,030	7/1991	Weder et al.	D11/164
D. 318,635	7/1991	Weder et al.	D11/164
D. 319,034	8/1991	Weder et al.	D11/164
D. 319,417	8/1991	Weder et al.	D11/164
D. 319,991	9/1991	Weder	D11/164
1,065,486	6/1913	Washburn	229/1.5 B
1,069,675	8/1913	Claussen	.	
1,446,563	2/1923	Hughes	.	
1,520,647	12/1924	Hennegan	.	
1,632,347	6/1927	Pipkin	.	
1,868,853	7/1932	Sievers	.	
1,924,926	8/1933	Gray	.	
1,951,642	3/1934	Augustin et al.	47/34
2,054,934	9/1936	Graffenberger	229/1.5 B
2,102,510	12/1937	Cecil, II	229/1.5 B
2,302,259	11/1942	Rothfuss	41/10
2,355,559	8/1944	Renner	229/8
2,482,981	9/1949	Kamrass	41/13
2,570,954	10/1951	Kasman	65/53
2,967,652	1/1961	Canfield et al.	229/5.5
3,022,605	2/1962	Reynolds	47/58
3,232,469	2/1966	Piazz	215/38
3,271,922	9/1966	Wallerstein et al.	53/3
3,488,022	1/1970	Vittori	248/152
3,542,616	11/1970	Cain et al.	156/224
3,820,684	6/1974	Harrison	206/520
3,962,503	6/1976	Crawford	428/40
4,043,077	8/1977	Stonehocker	47/66
4,118,890	10/1978	Shore	47/28
4,170,618	10/1979	Adams	264/101
4,216,620	8/1980	Weder et al.	47/72
4,300,312	11/1981	Weder et al.	47/72
4,408,644	10/1983	Svantesson	150/55
4,413,725	11/1983	Bruno et al.	206/45.33
4,508,223	4/1985	Catrambone	206/423
4,712,725	12/1987	Moore	229/8
4,733,521	3/1988	Weder et al.	53/580
4,773,182	9/1988	Weder et al.	47/72
4,795,601	1/1989	Cheng	264/138
4,813,862	3/1989	Bowers et al.	425/87
4,835,834	6/1989	Weder	29/525

OTHER PUBLICATIONS

Exhibit H. "Speed Cover®" brochure, published in 1983 by Applicants, showing various pot covers for sale.

Exhibit I. "Speed Cover®" brochure, published in 1983 by Applicants, showing various pot covers for sale.

Exhibit J. Item published in 1936 by Gellman Bros., Minneapolis, Minn. Shows an assortment of paper hats.

Exhibit N. "Speed Cover®" brochure, published in 1984 by Applicants, showing various pot covers for sale.

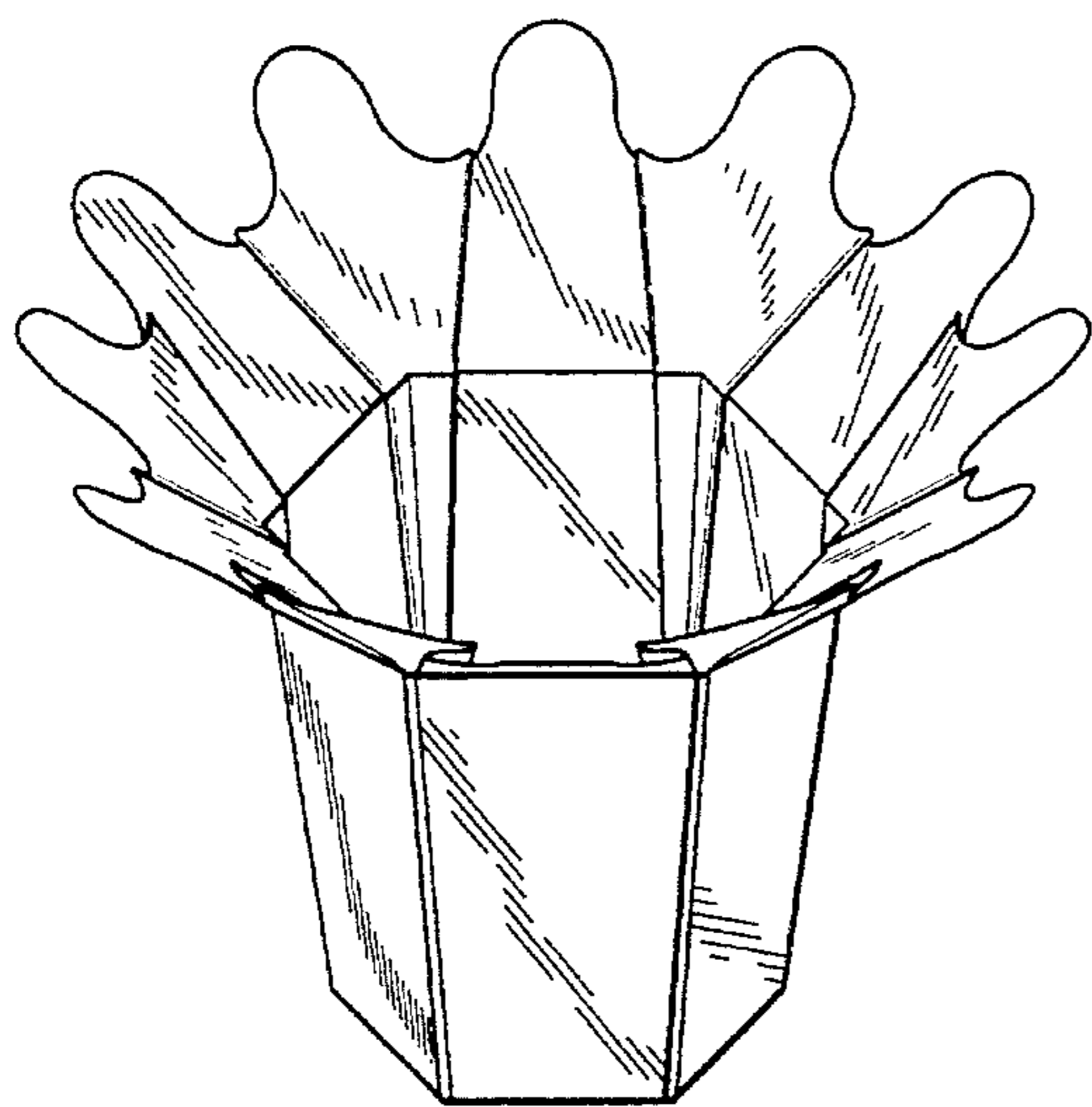

FIG. 1

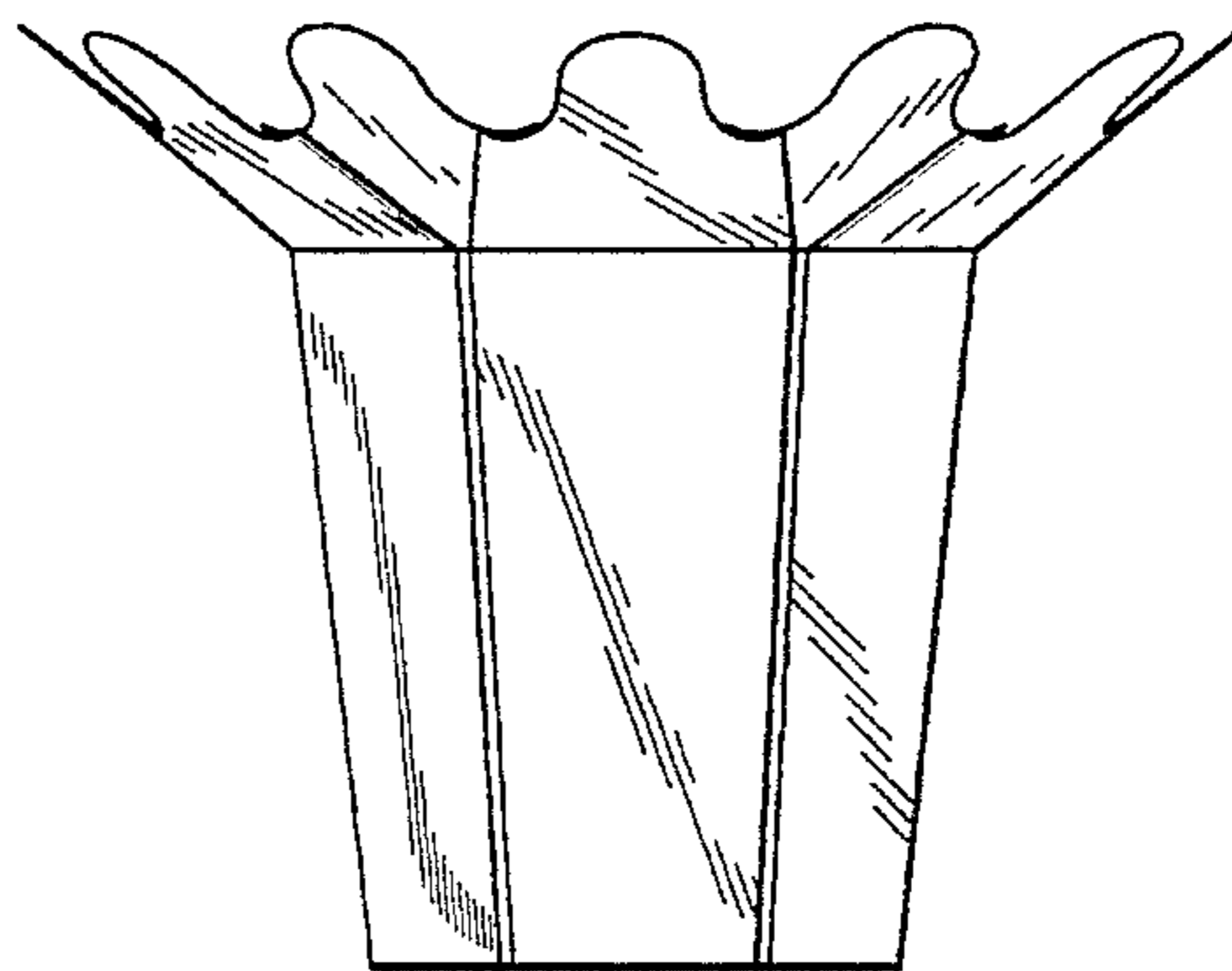

FIG. 2

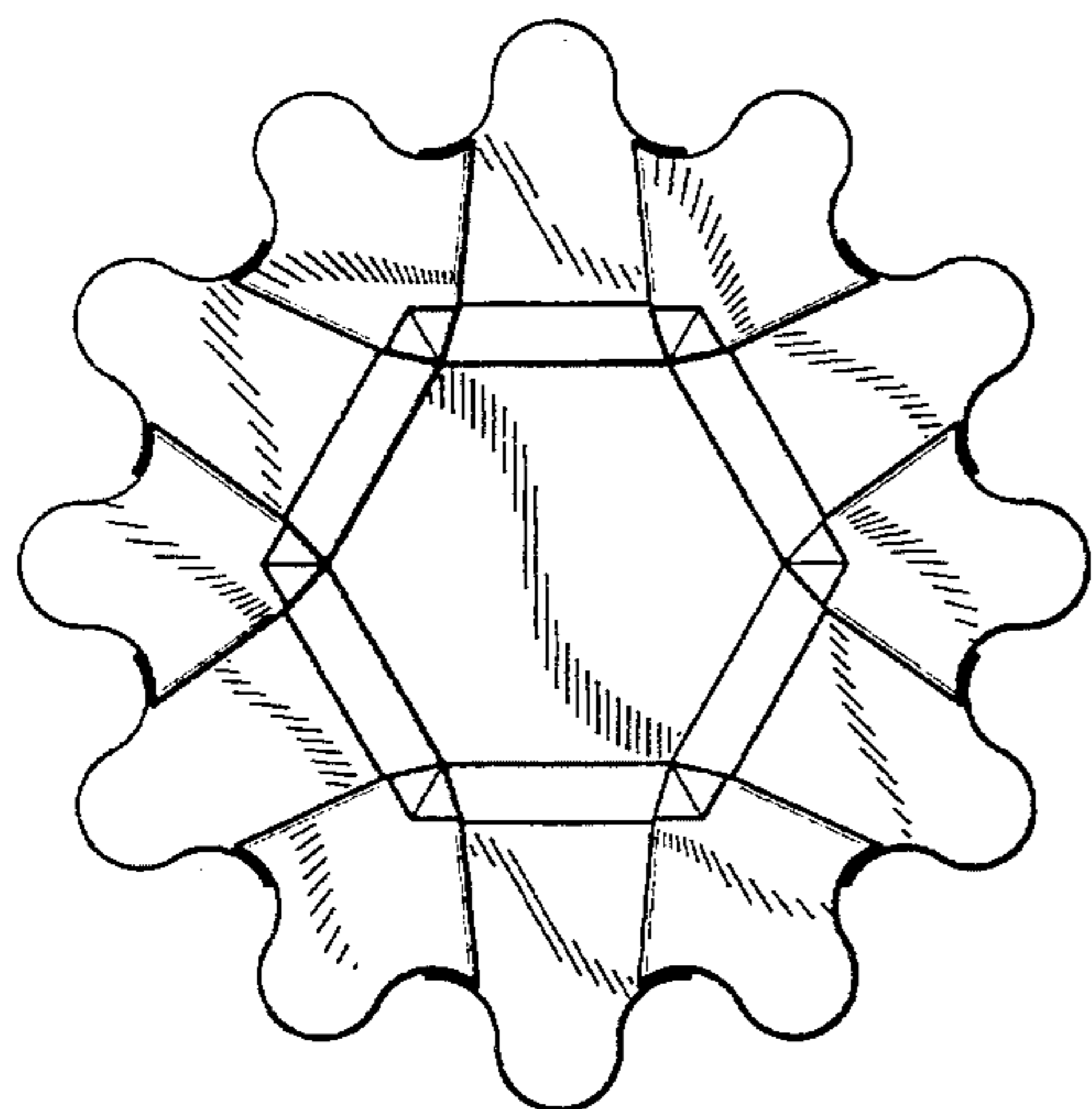

FIG. 3

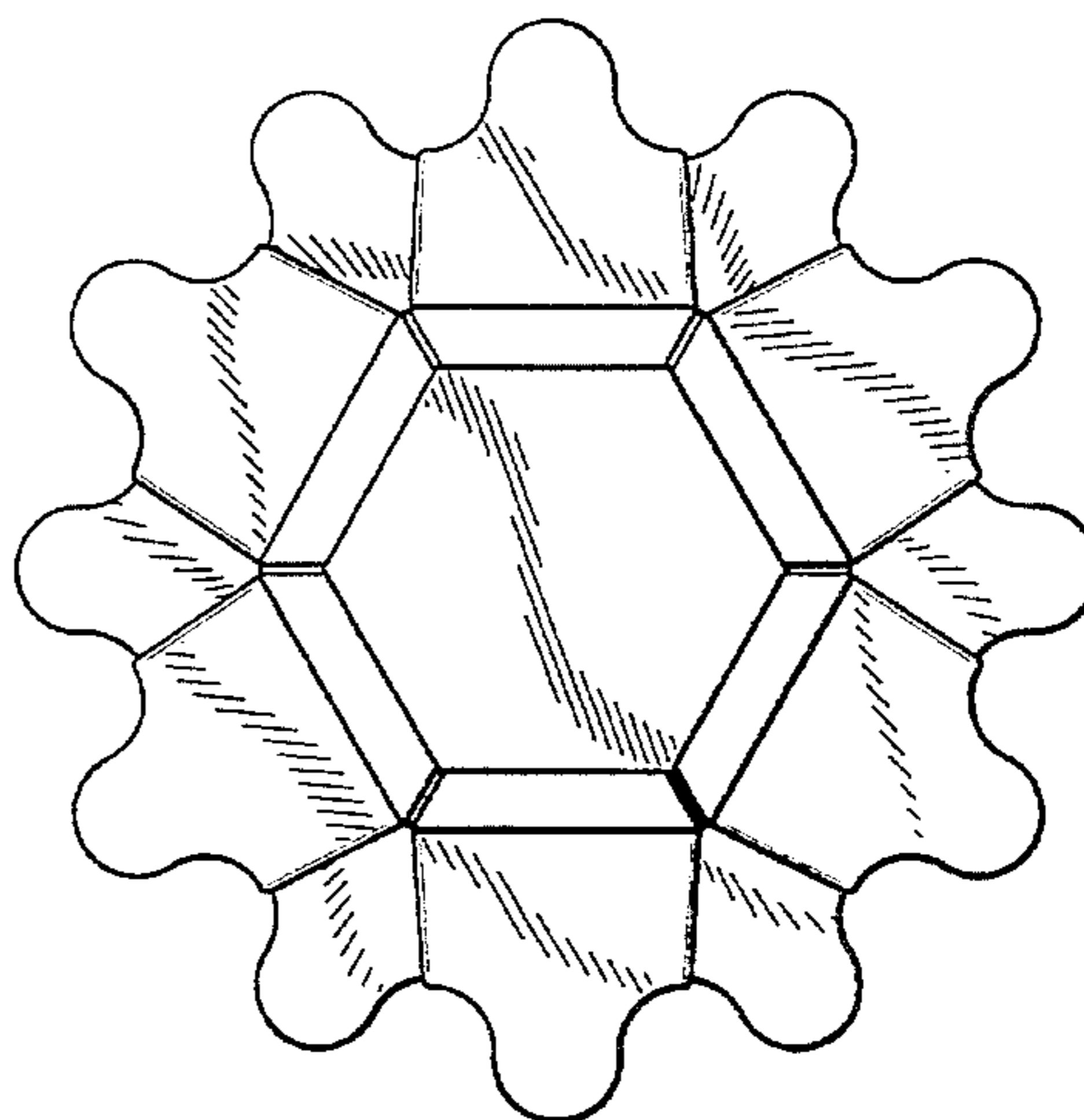

FIG. 4

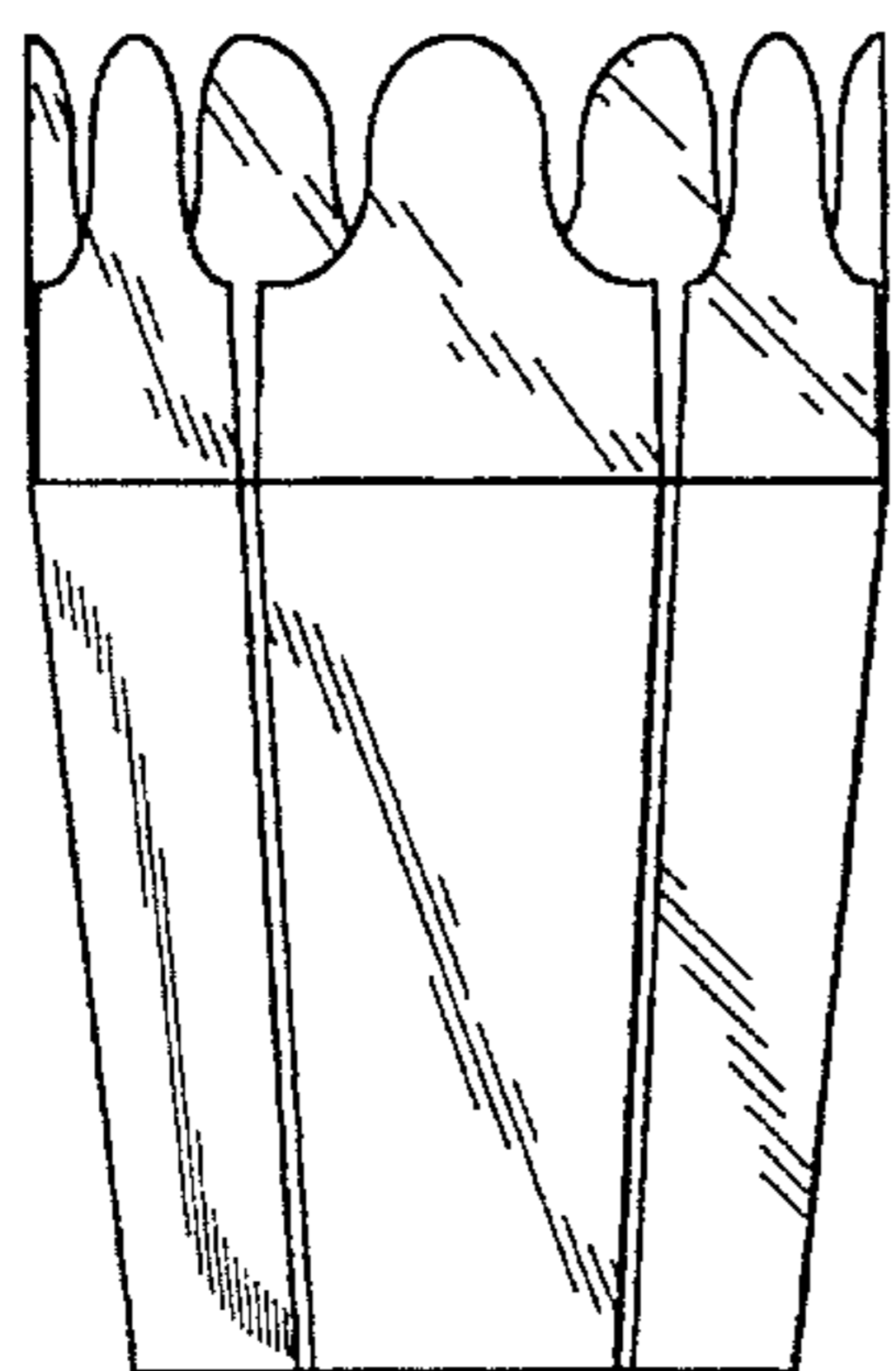

FIG. 5

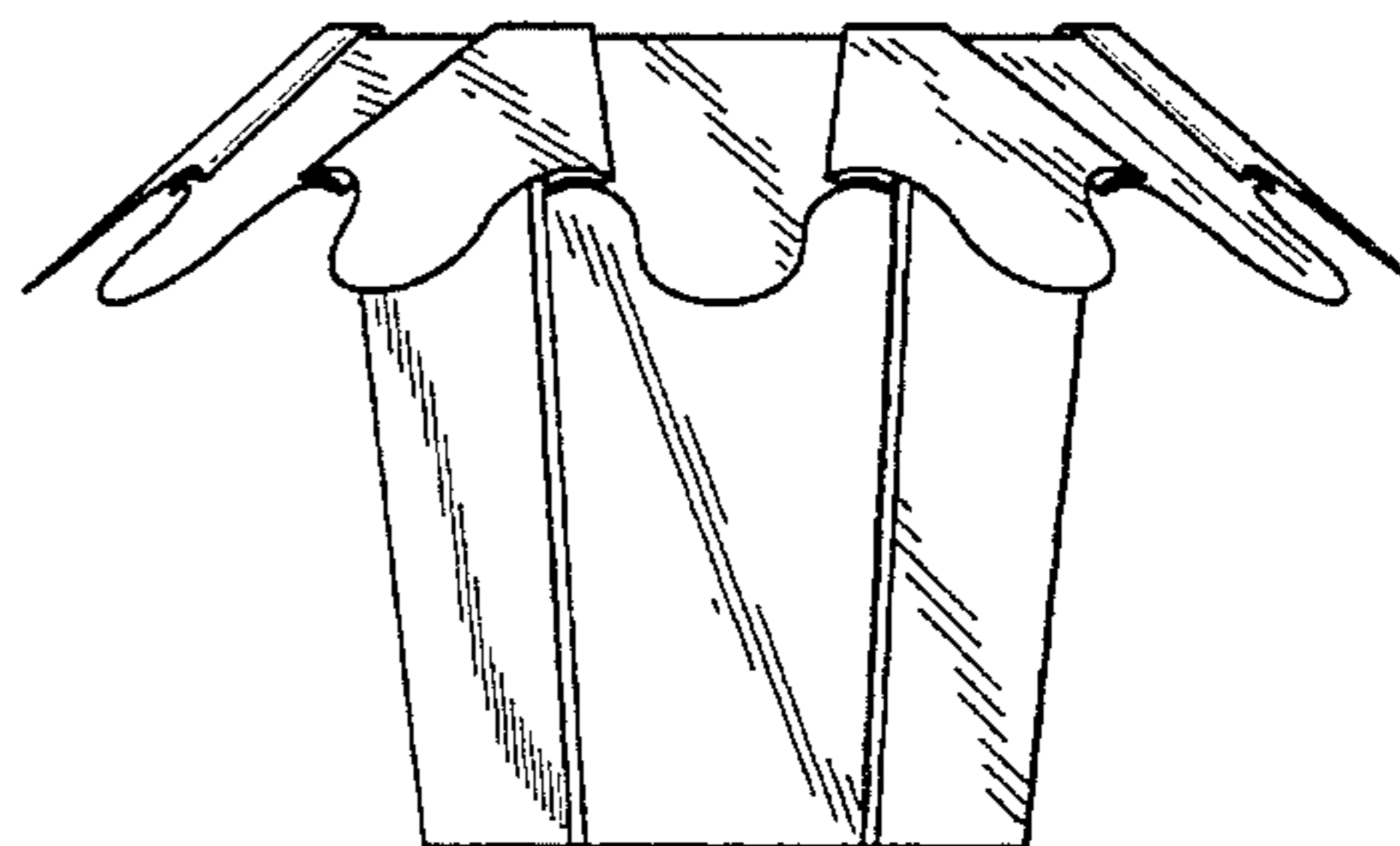

FIG. 6

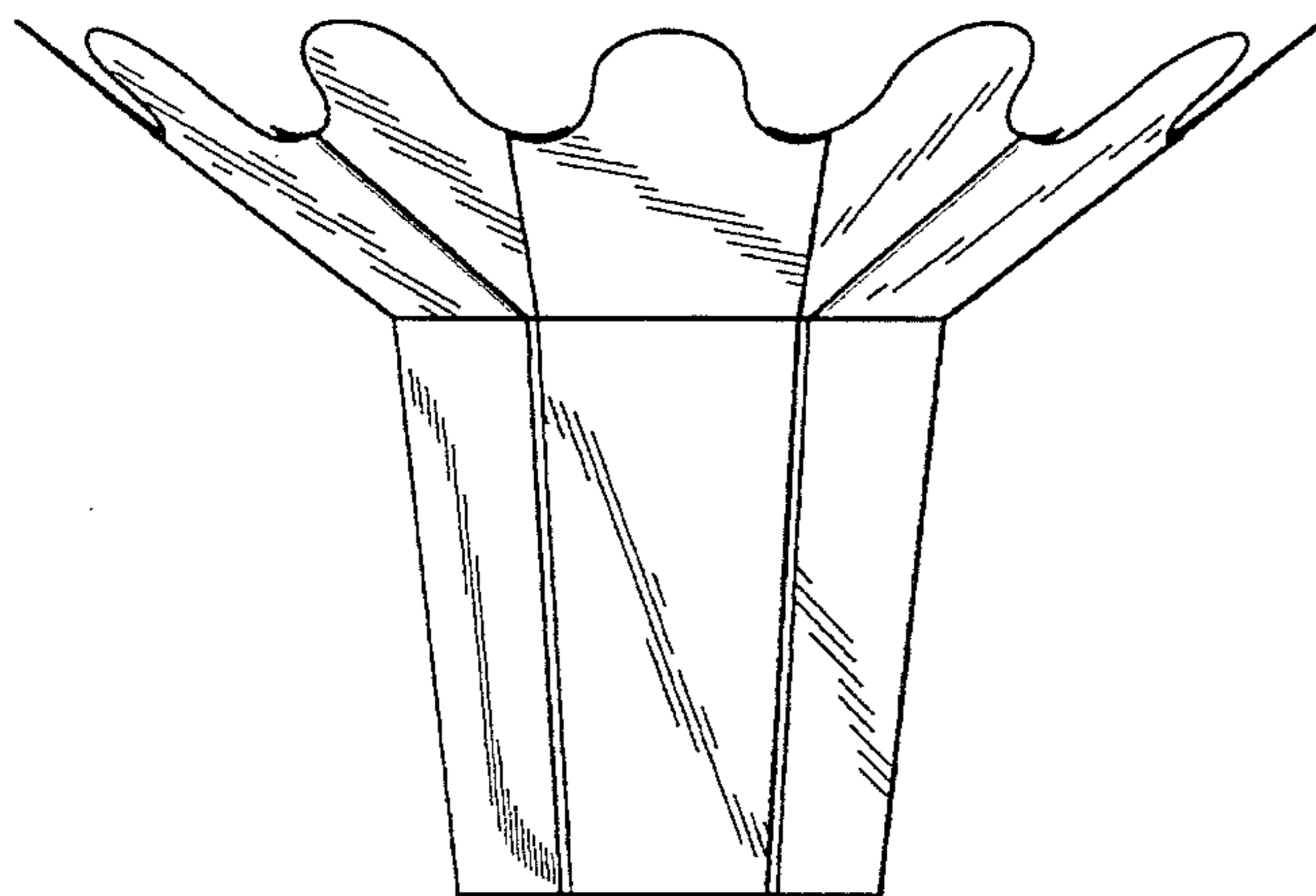

FIG. 7

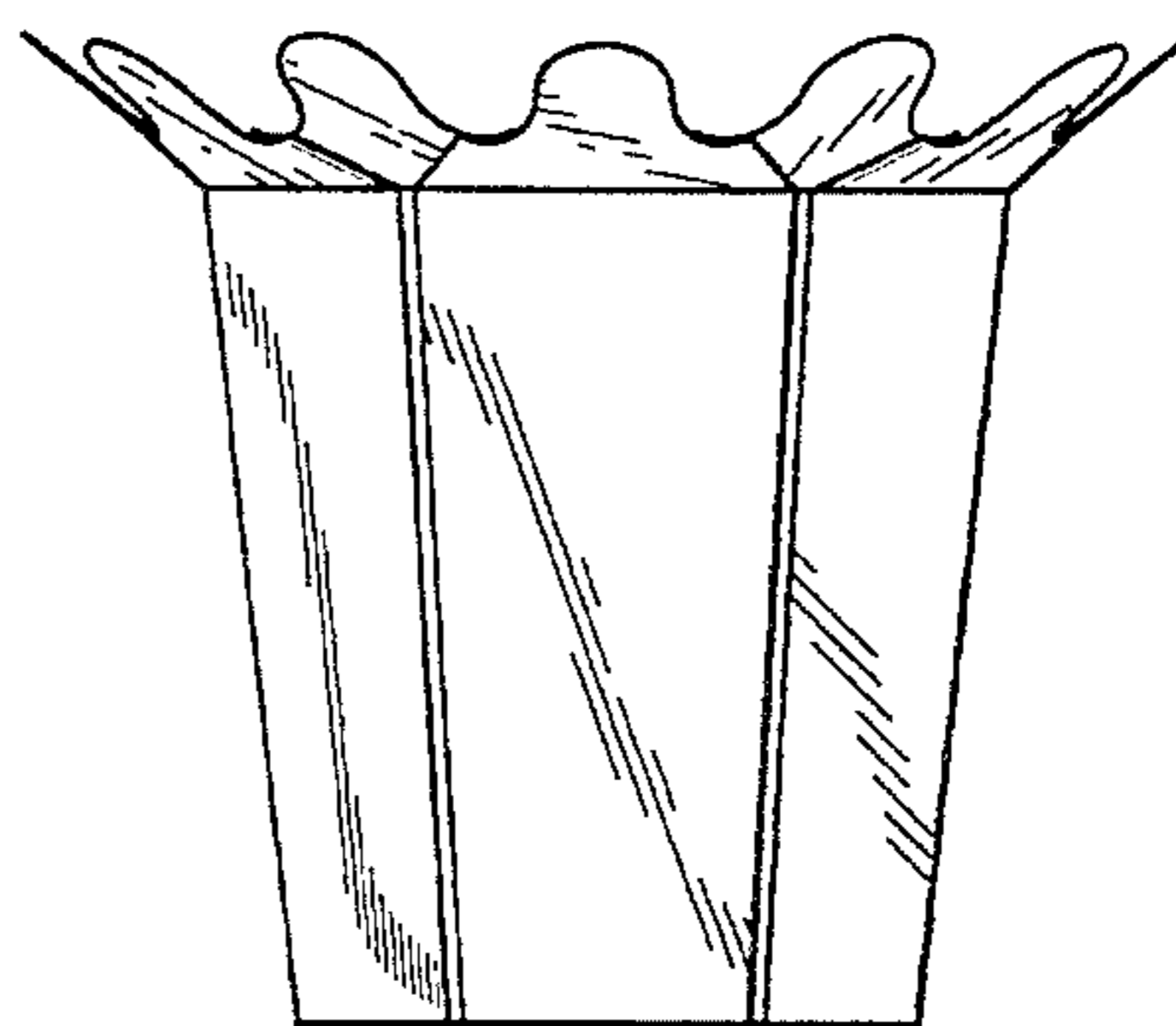

FIG. 8

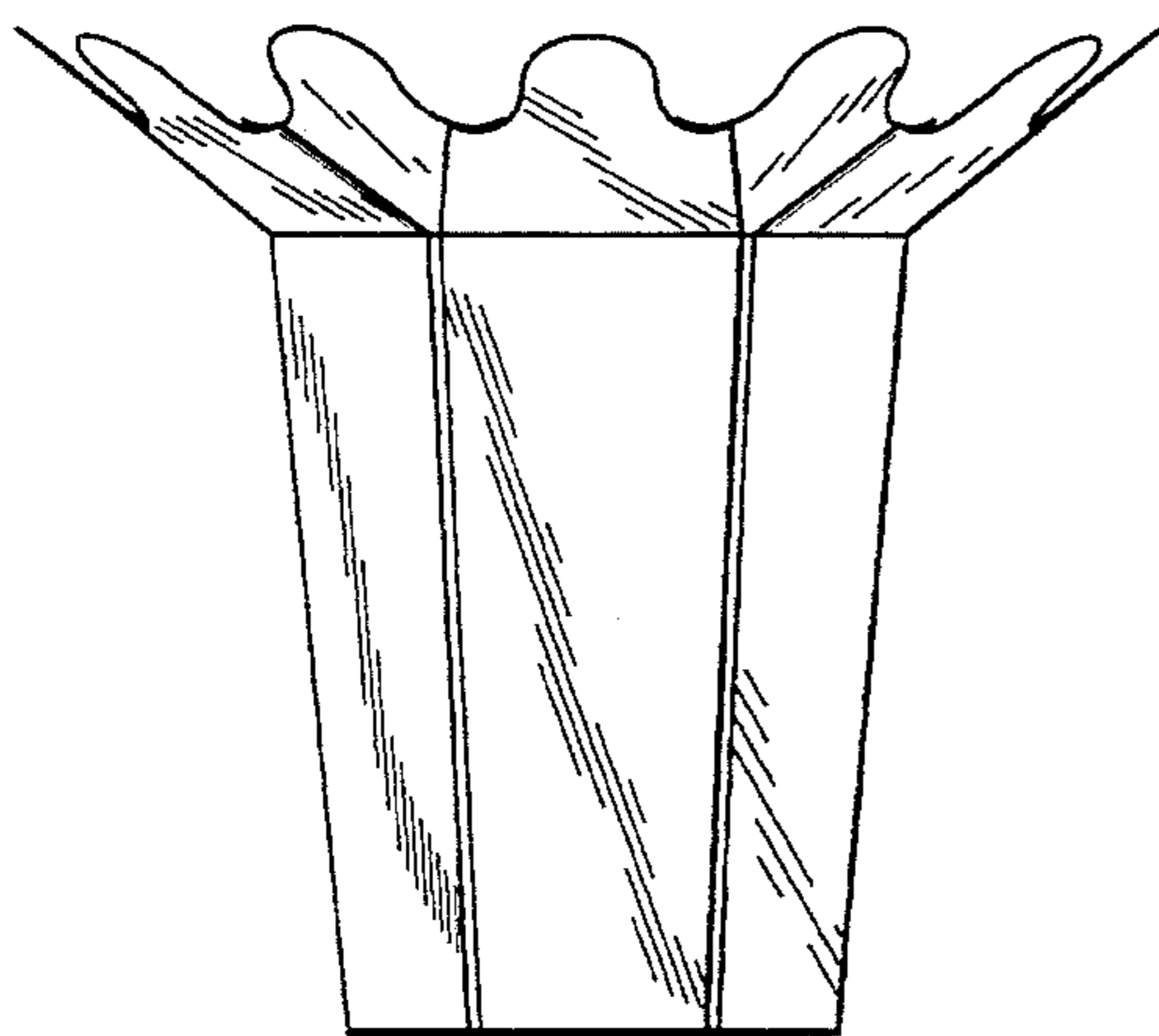

FIG. 9

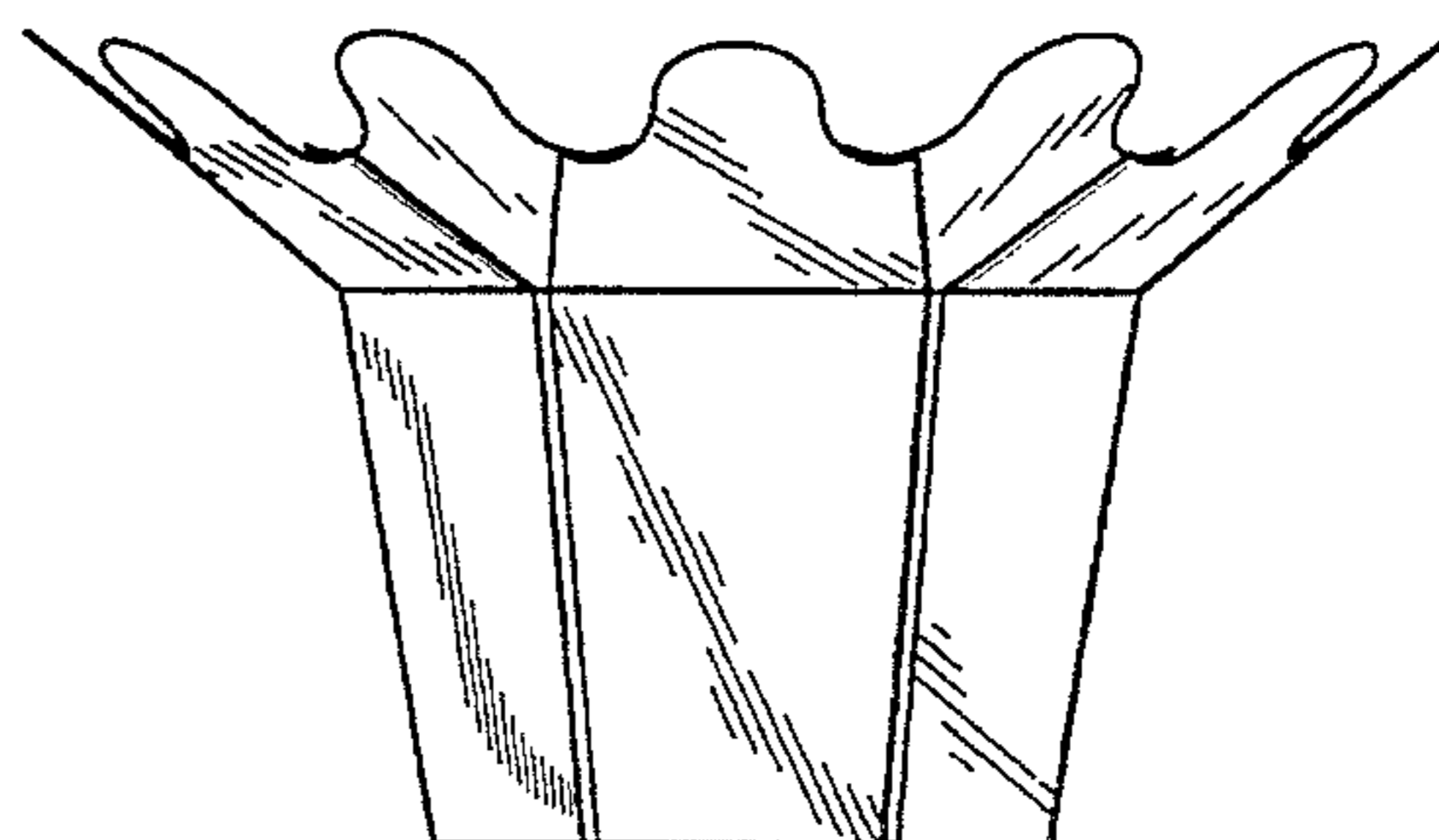

FIG. 10