



US00D362823S

United States Patent [19]

[11] Patent Number: **Des. 362,823**

Weder et al.

[45] Date of Patent: ***** Oct. 3, 1995**

[54] **FLOWER POT COVER**

[75] Inventors: **Donald E. Weder; Joseph G. Straeter**, both of Highland, Ill.

[73] Assignee: **Highland Supply Corporation**, Highland, Ill.

[*] Notice: The portion of the term of this patent subsequent to Nov. 5, 2005 has been disclaimed.

[**] Term: **14 Years**

[21] Appl. No.: **808,360**

[22] Filed: **Dec. 16, 1991**

Related U.S. Application Data

[63] Continuation-in-part of Ser. No. 710,272, Jun. 4, 1991, abandoned, which is a continuation-in-part of Ser. No. 617,454, Nov. 21, 1990, abandoned, and Ser. No. 411,249, Sep. 22, 1989, and Ser. No. 411,247, Sep. 22, 1989, and Ser. No. 411,245, Sep. 22, 1989.

[52] U.S. Cl. **11/164; D11/143**

[58] Field of Search **D11/143, 152, D11/153, 154, 155, 156, 164; 47/66, 72; 206/423; 215/100.5; 229/1.5 B, 4.5, 922; 248/27.8, 35.1, 542.6**

References Cited

U.S. PATENT DOCUMENTS

D. 47,800 9/1915 Pick .
D. 132,559 5/1942 Sawyer D11/153
209,788 11/1878 Affel .

(List continued on next page.)

FOREIGN PATENT DOCUMENTS

103316 3/1938 Australia 229/922
560532 4/1975 Switzerland .

OTHER PUBLICATIONS

Exhibit A. Curtis Wagner Co., Inc., Houston, Tex., shows thick, stiff shiny red plastic pot cover with large scalloped border. (Photograph) Date unknown.

Exhibit A —Sopeed Cover® Brochure —The Simple Solution . . . , © 1989.

(List continued on next page.)

Primary Examiner—Martie Thompson
Attorney, Agent, or Firm—Dunlap & Coddling

[57] CLAIM

The ornamental design for a flower pot cover, as shown and described.

DESCRIPTION

FIG. 1 is a perspective view of our new flower pot cover design;

FIG. 2 is a reduced top plan view thereof;

FIG. 3 is a reduced side elevational view thereof;

FIG. 4 is a reduced bottom plan view thereof;

FIG. 5 is a reduced side elevational view of the front side thereof;

FIG. 6 is a top plan view of a second embodiment of our new design;

FIG. 7 is a top plan view of a third embodiment of our new design;

FIG. 8 is a reduced bottom plan view of FIG. 7;

FIG. 9 is a reduced side elevational view of the design of FIG. 1, the only difference being the angle of the skirt;

FIG. 10 is a reduced side elevational view of the design of FIG. 1, the only difference being the angle of the skirt;

FIG. 11 is a reduced side elevational view of the design of FIG. 6;

FIG. 12 is a reduce side elevational view of the design of FIG. 6, the only difference being the angle of the skirt;

FIG. 13 is a reduced side elevational view of the design of FIG. 6, the only difference being the angle of the skirt;

FIG. 14 is a reduce side elevational view of the design of FIG. 7;

FIG. 15 is a reduced side elevational view of the design of FIG. 7, the only difference being the angle of the skirt; and,

FIG. 16 is a reduced side elevational view of the design of FIG. 7, the only difference being the angle of the skirt.

The flower pot cover has no substantial thickness.

The characteristic feature of the design resides in the specific pleating arrangement comprised of the parallel disposition of the exterior folds in combination with the interior V-shaped folds all as best shown in FIG. 1.

1 Claim, 4 Drawing Sheets

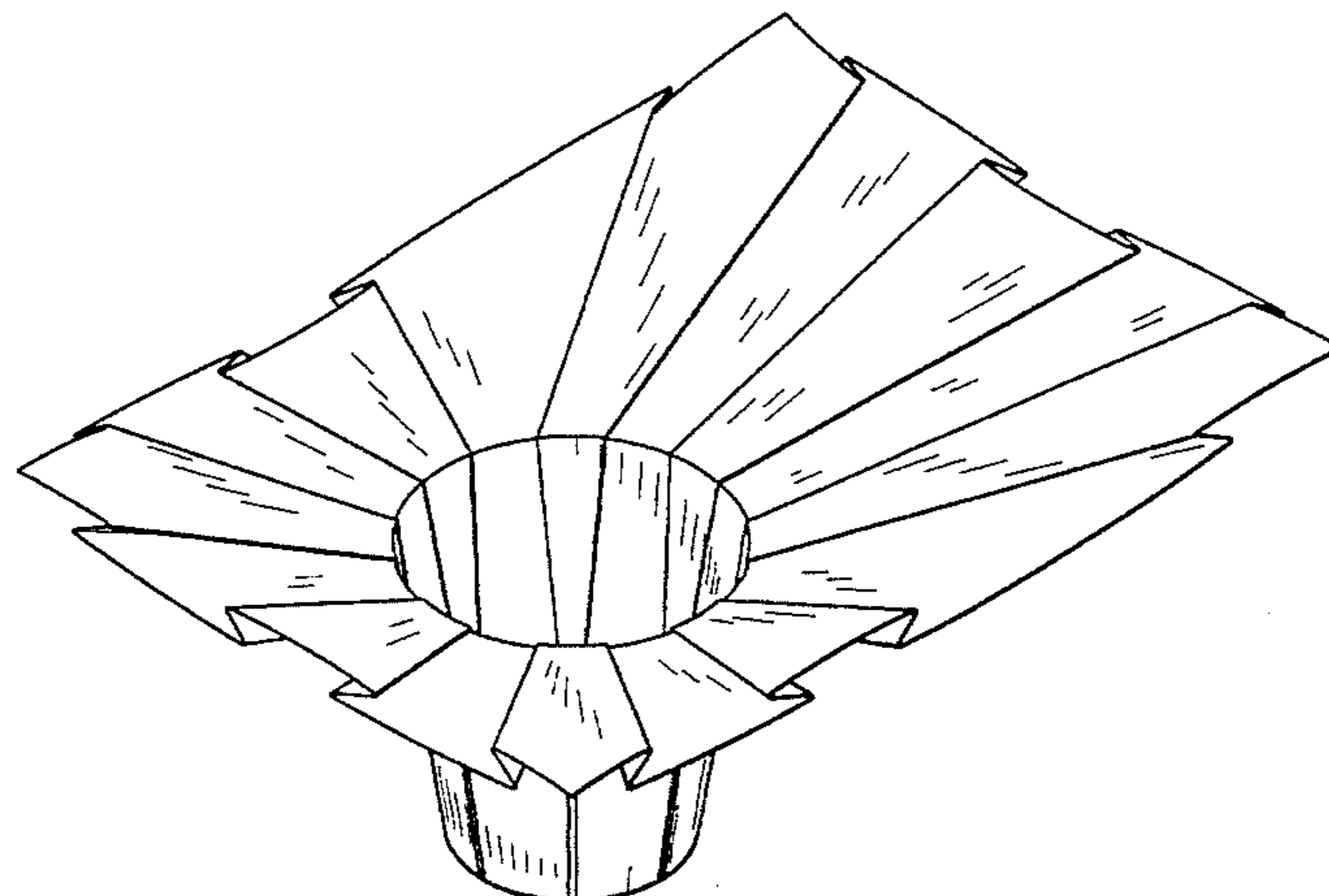

U.S. PATENT DOCUMENTS

D. 254,659	4/1980	Karotseris	D11/143	1,069,675	8/1913	Claussen	.
D. 287,950	1/1987	Weder et al.	D11/143	1,446,563	2/1923	Hughes	.
D. 289,024	3/1987	Vaughn	D11/164	1,520,647	12/1924	Hennegan	.
D. 289,982	5/1987	Weder et al.	D11/164	1,632,347	6/1927	Pipkin	.
D. 292,182	10/1987	Weder et al.	D11/164	1,868,853	7/1932	Sievers	.
D. 292,183	10/1987	Weder et al.	D11/164	1,924,926	8/1933	Gray	.
D. 292,184	10/1987	Weder et al.	D11/164	1,951,642	3/1934	Augustin et al.	47/34
D. 292,185	10/1987	Weder et al.	D11/164	2,054,934	9/1936	Graffenberger	229/1.5 B
D. 292,186	10/1987	Weder et al.	D11/164	2,102,510	12/1937	Cecil, II	229/1.5 B
D. 292,187	10/1987	Weder et al.	D11/164	2,302,259	11/1942	Rothfuss	41/10
D. 292,188	10/1987	Weder et al.	D11/164	2,355,559	8/1944	Renner	229/8
D. 292,189	10/1987	Weder et al.	D11/164	2,482,981	9/1949	Kamrass	41/13
D. 292,190	10/1987	Weder et al.	D11/164	2,570,954	10/1951	Kasman	65/53
D. 292,191	10/1987	Weder et al.	D11/164	2,967,652	1/1961	Canfield et al.	229/5.5
D. 292,561	11/1987	Weder et al.	D11/164	3,022,605	2/1962	Reynolds	47/58
D. 292,562	11/1987	Weder et al.	D11/164	3,232,469	2/1966	Piazz	215/38
D. 292,563	11/1987	Weder et al.	D11/164	3,271,922	9/1966	Wallerstein et al.	53/3
D. 293,222	12/1987	Weder et al.	D11/164	3,488,022	1/1970	Vittori	248/152
D. 293,223	12/1987	Weder et al.	D11/164	3,542,616	11/1970	Cain et al.	156/224
D. 293,224	12/1987	Weder et al.	D11/164	3,820,684	6/1974	Harrison	206/520
D. 293,304	12/1987	Weder et al.	D11/164	3,962,503	6/1976	Crawford	428/40
D. 293,305	12/1987	Weder et al.	D11/164	4,043,077	8/1977	Stonehocker	47/66
D. 293,306	12/1987	Weder et al.	D11/164	4,118,890	10/1978	Shore	47/28
D. 293,307	12/1987	Weder et al.	D11/164	4,170,618	10/1979	Adams	264/101
D. 293,308	12/1987	Weder et al.	D11/164	4,216,620	8/1980	Weder et al.	47/72
D. 293,774	1/1988	Weder et al.	D11/164	4,300,312	11/1981	Weder et al.	47/72
D. 293,775	1/1988	Weder et al.	D11/164	4,408,644	10/1983	Svantesson	150/55
D. 296,535	7/1988	Weder et al.	D11/149	4,413,725	11/1983	Bruno et al.	206/45.33
D. 297,422	8/1988	Weder et al.	D11/164	4,508,223	4/1985	Catrambone	206/423
D. 298,017	10/1988	Weder et al.	D11/164	4,712,725	12/1987	Moore	229/8
D. 301,565	6/1989	Weder	D11/152	4,733,521	3/1988	Weder et al.	53/580
D. 302,139	7/1989	Weder	D11/153	4,773,182	9/1988	Weder et al.	47/72
D. 302,253	7/1989	Weder	D11/153	4,795,601	1/1989	Cheng	264/138
D. 302,254	7/1989	Weder	D11/153	4,813,862	3/1989	Bowers et al.	425/87
D. 302,404	7/1989	Weder	D11/153	4,835,834	6/1989	Weder	29/525
D. 302,405	7/1989	Weder	D11/155				
D. 302,406	7/1989	Weder	D11/155				
D. 303,759	10/1989	Mileos	D9/306				
D. 303,775	10/1989	Weder	D11/155				
D. 304,407	7/1989	Weder	D11/155				
D. 313,376	1/1991	Weder	D11/164				
D. 313,573	1/1991	Weder et al.	D11/164				
D. 313,574	1/1991	Weder et al.	D11/164				
D. 313,575	1/1991	Weder et al.	D11/164				
D. 313,576	1/1991	Weder	D11/164				
D. 314,732	2/1991	Weder	D11/164				
D. 315,534	3/1991	Weder et al.	D11/164				
D. 315,878	4/1991	Weder et al.	D11/164				
D. 315,879	4/1991	Weder et al.	D11/164				
D. 315,880	4/1991	Weder et al.	D11/164				
D. 315,881	4/1991	Weder et al.	D11/164				
D. 315,882	4/1991	Weder	D11/164				
D. 315,883	4/1991	Weder	D11/164				
D. 316,060	4/1991	Weder	D11/164				
D. 316,061	4/1991	Weder	D11/164				
D. 316,062	4/1991	Weder et al.	D11/164				
D. 316,837	5/1991	Weder et al.	D11/164				
D. 316,838	5/1991	Weder et al.	D11/164				
D. 316,985	5/1991	Weder	D11/164				
D. 317,424	6/1991	Weder	D11/164				
D. 317,582	6/1991	Weder	D11/164				
D. 317,583	6/1991	Weder et al.	D11/164				
D. 318,029	7/1991	Weder	D11/164				
D. 318,030	7/1991	Weder et al.	D11/164				
D. 318,635	7/1991	Weder et al.	D11/164				
D. 319,034	8/1991	Weder et al.	D11/164				
D. 319,417	8/1991	Weder et al.	D11/164				
D. 319,991	9/1991	Weder	D11/164				
D. 321,332	11/1991	Weder et al.	D11/164				
1,065,486	6/1913	Washburn	229/1.5 B				

OTHER PUBLICATIONS

Exhibit B. Jacobson Pot Cover Company of Scranton, Pennsylvania. advertising literature. Date of first use unknown.

Exhibit C. Photograph of pot cover, manufacturer unknown, but very similar to #C21 on Exhibit B (Jacobson literature). Date unknown.

Exhibit D. Photocopy of photo of pot cover ("Platform Pot Dresser") made by John Raisen Corp., San Francisco, Calif. Date of first use unknown.

Exhibit E. Photograph of 2-part pot cover system made by Floral Decor, subsidiary of John Henry Co., Lansing Mich. Date unknown.

Exhibit F. Photo of pot cover made by a Holland company (K.P.I.). Date of first public use believed to be late 1984.

Exhibit G. "The glass of Frederick Carder", copyright 1972 by P. V. Gardner, showing various styles of glass basket-like vases or containers.

Exhibit H. "Speed Cover®" brochure, published in 1983 by Applicants, showing various pot covers for sale.

Exhibit I. "Speed Cover®" brochure, published in 1983 by Applicants, showing various pot covers for sale.

Exhibit J. Item published in 1936 by Gellman Bros., Minneapolis, Minn. Shows an assortment of paper hats.

Exhibit K. Photo of various other flower pot wrappings, sold in rolls or sheets and used in the floral industry for years. Date unknown.

Exhibit L. Photo of pot cover made of woven straw-like material. Date unknown.

Exhibit M. Photo of basket-type pot cover used in the floral industry. Date unknown.

Exhibit N. "Speed cover®" brochure, published in 1984 by Applicants, showing various pot covers for sale.

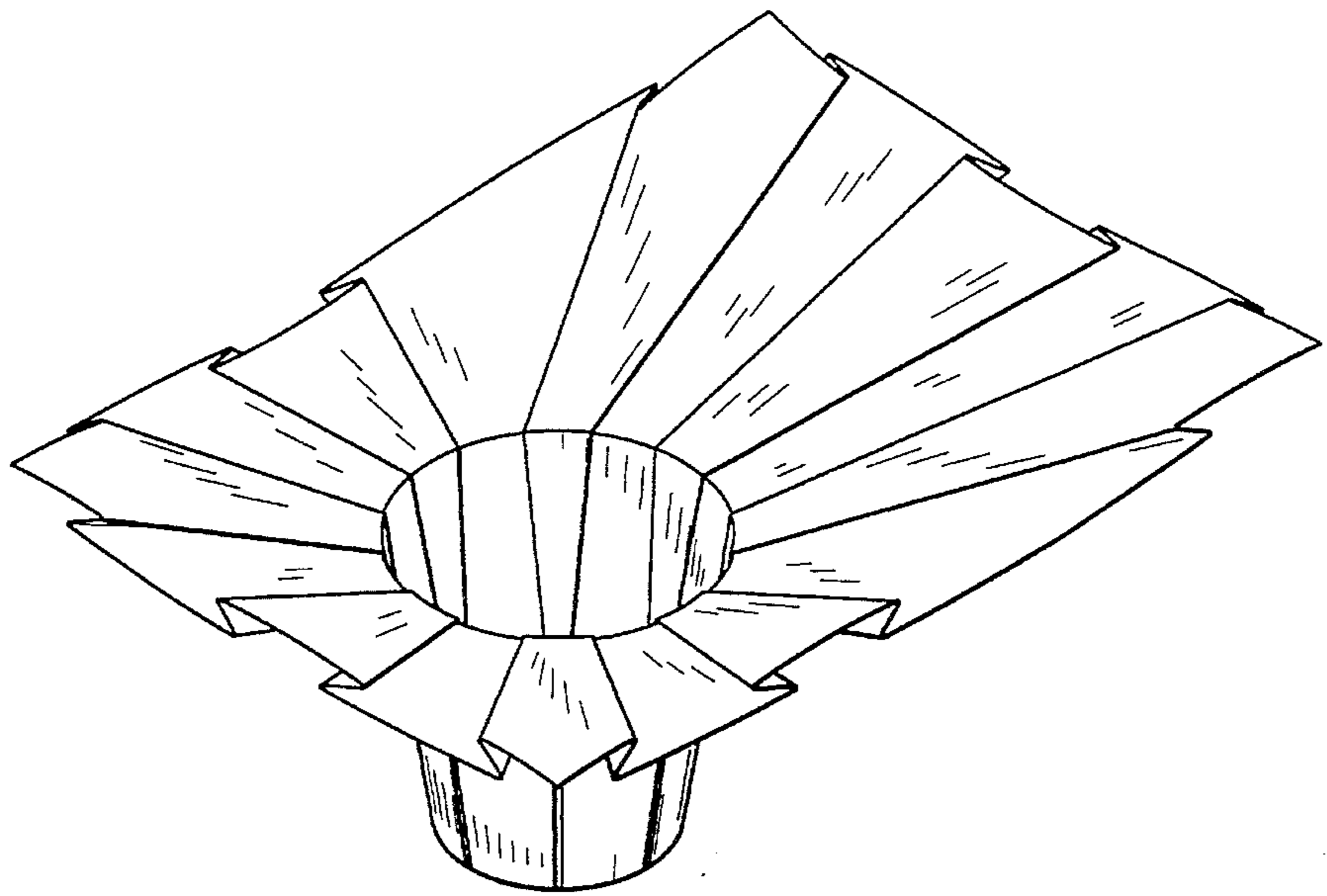

FIG. 1

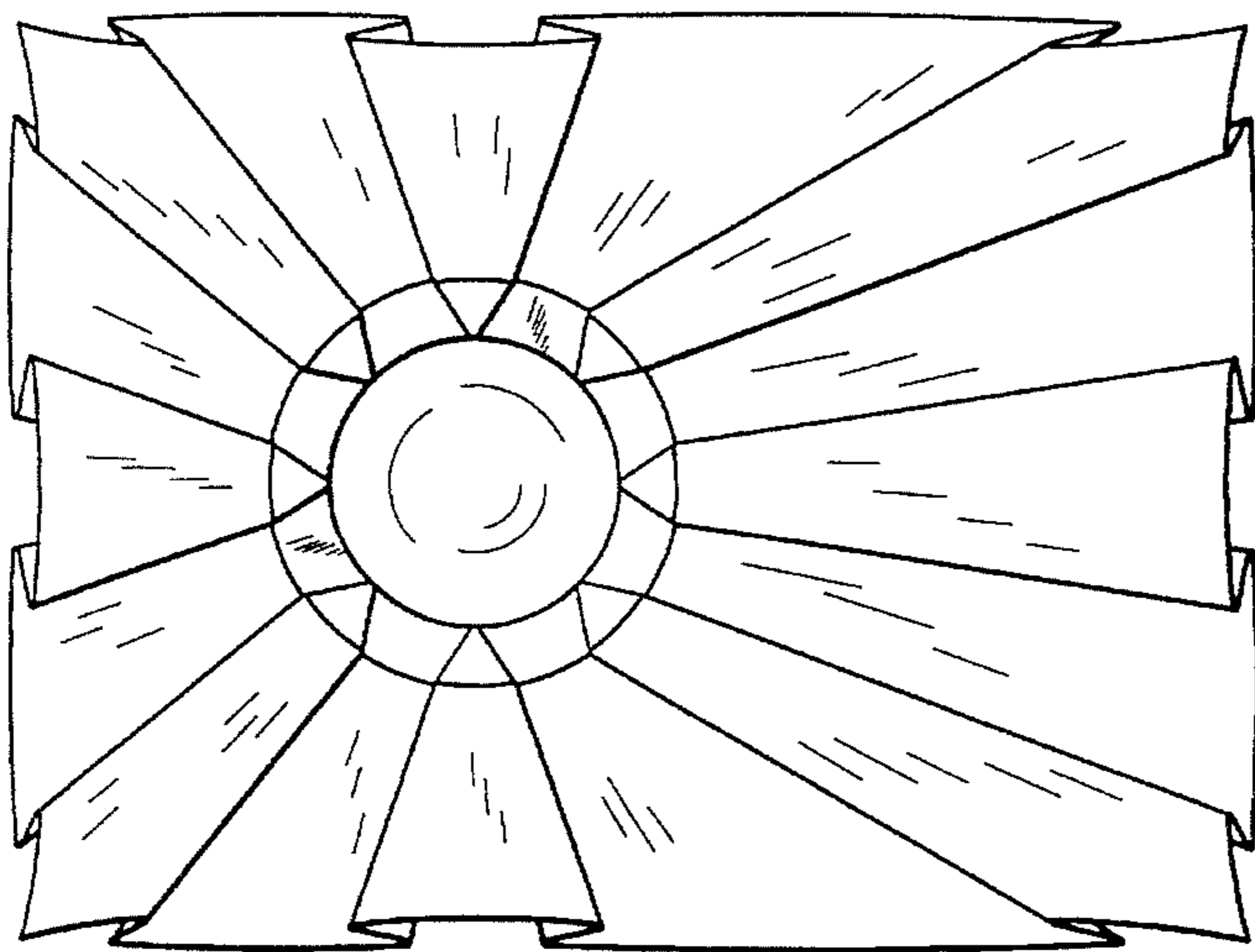

FIG. 2

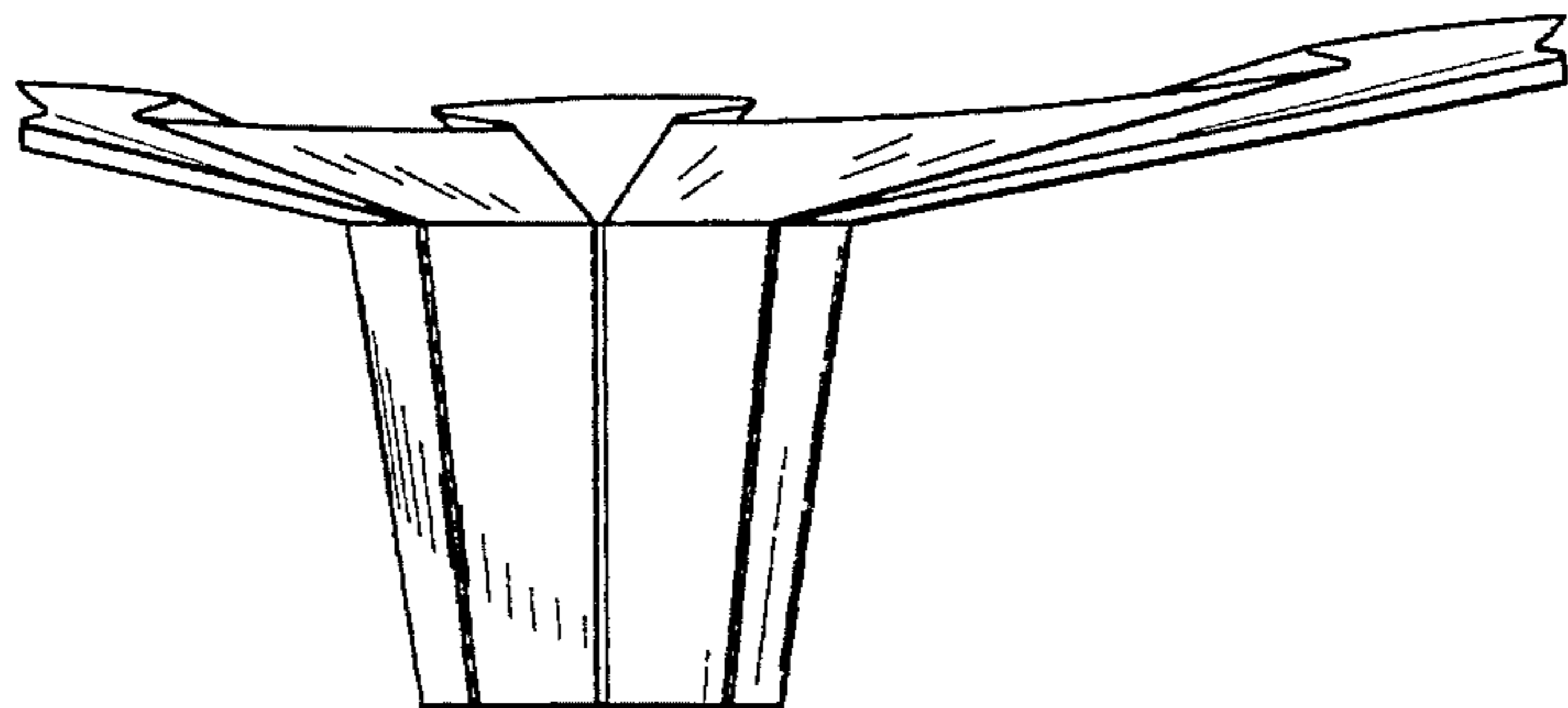

FIG. 3

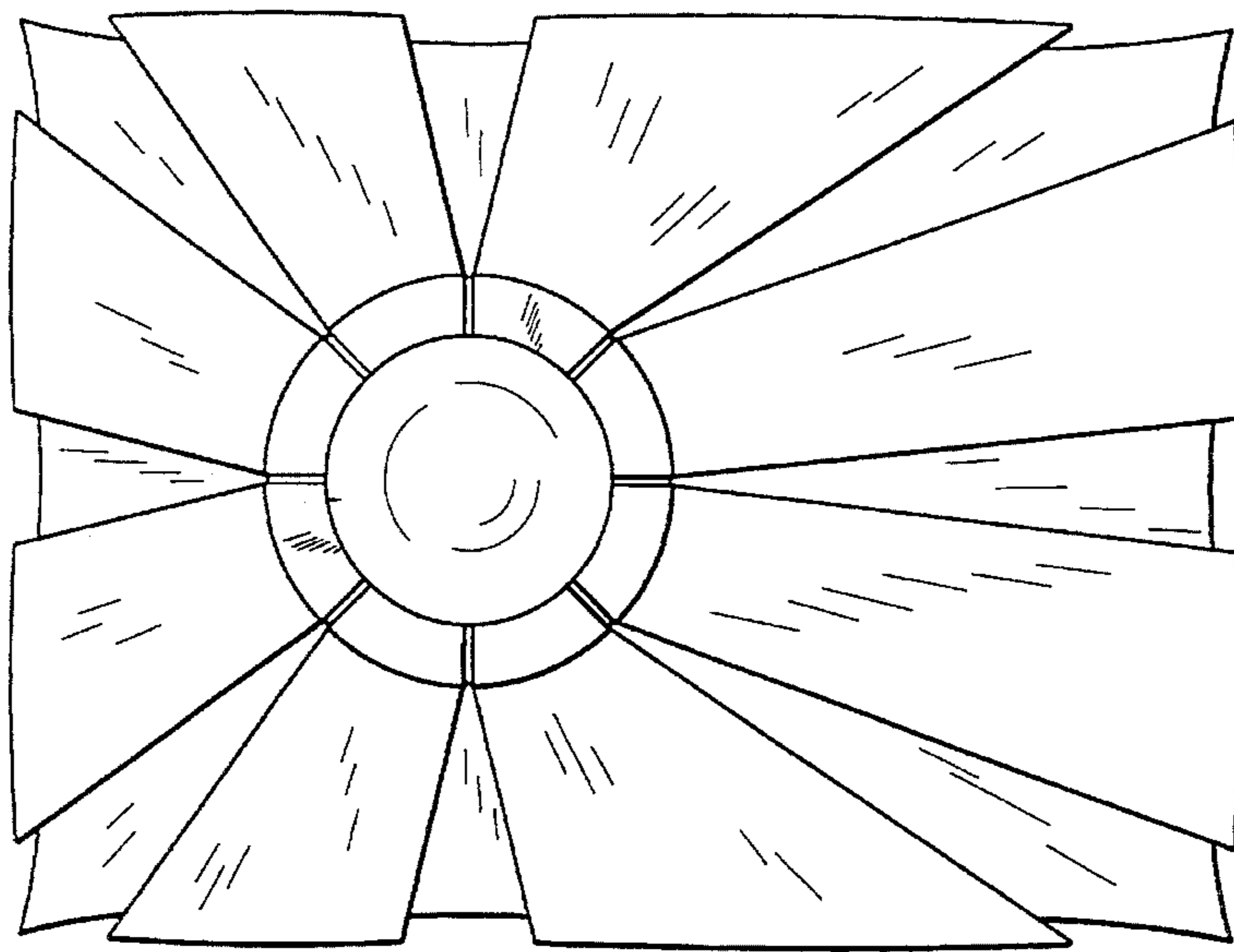

FIG. 4

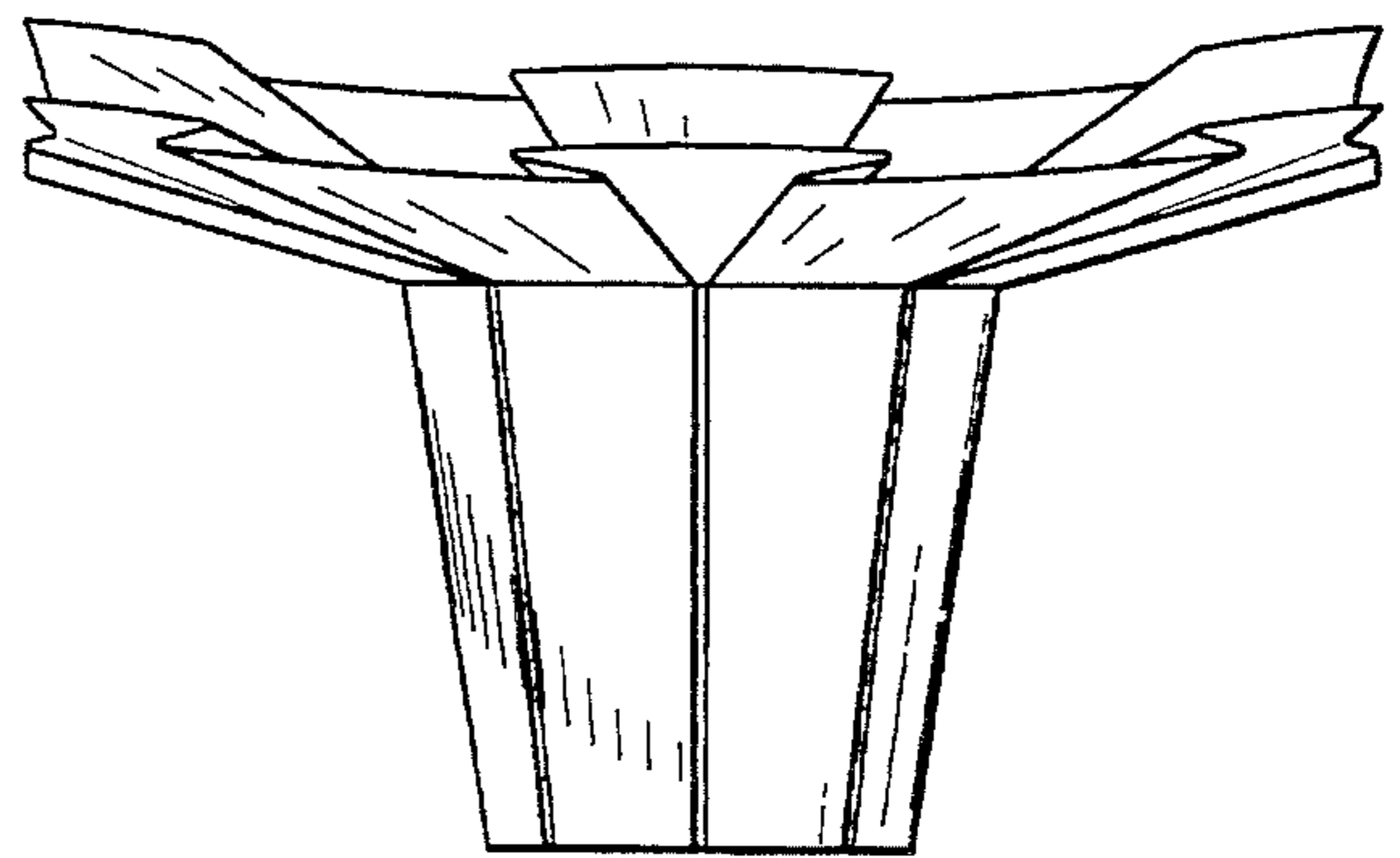

FIG. 5

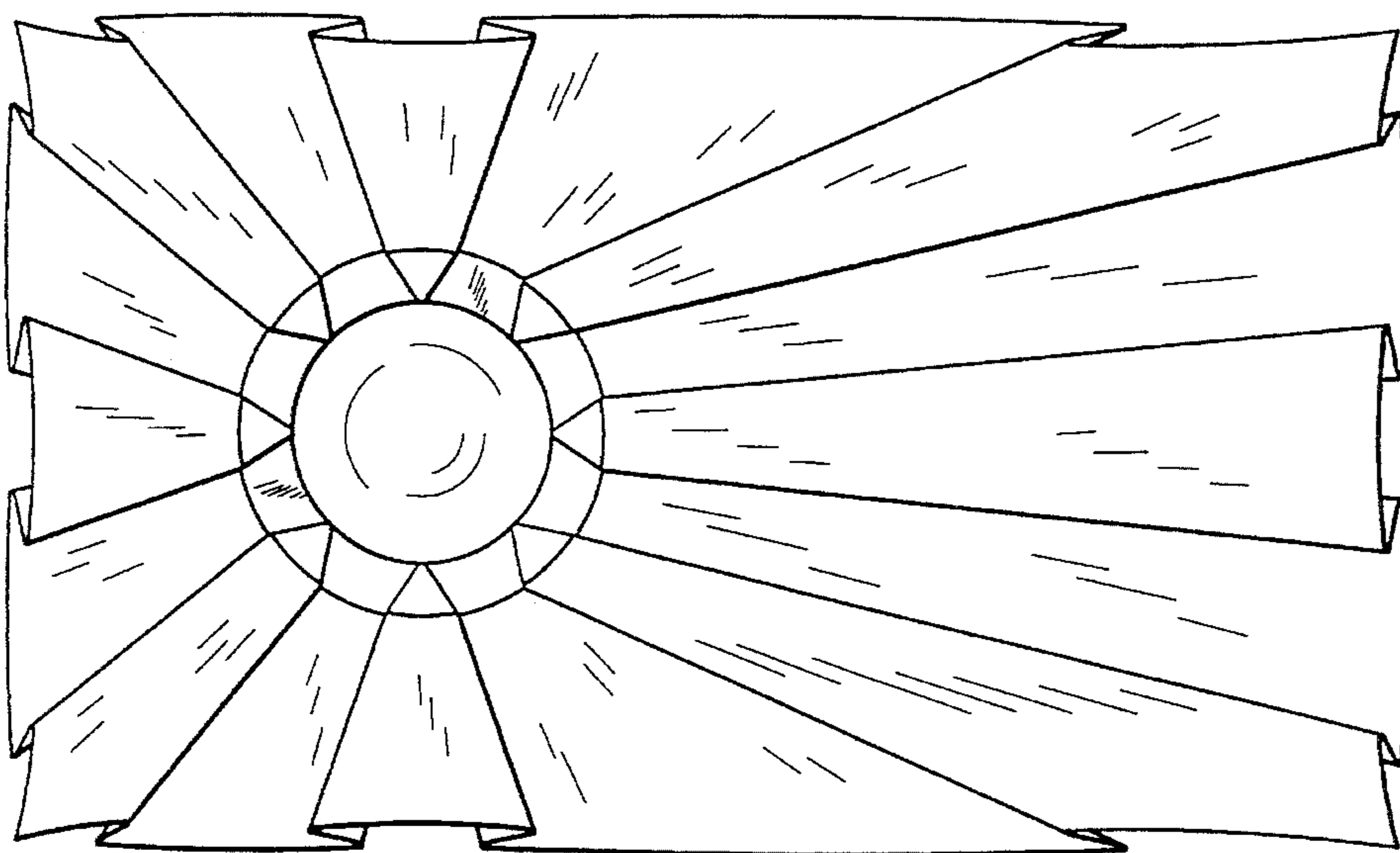

FIG. 6

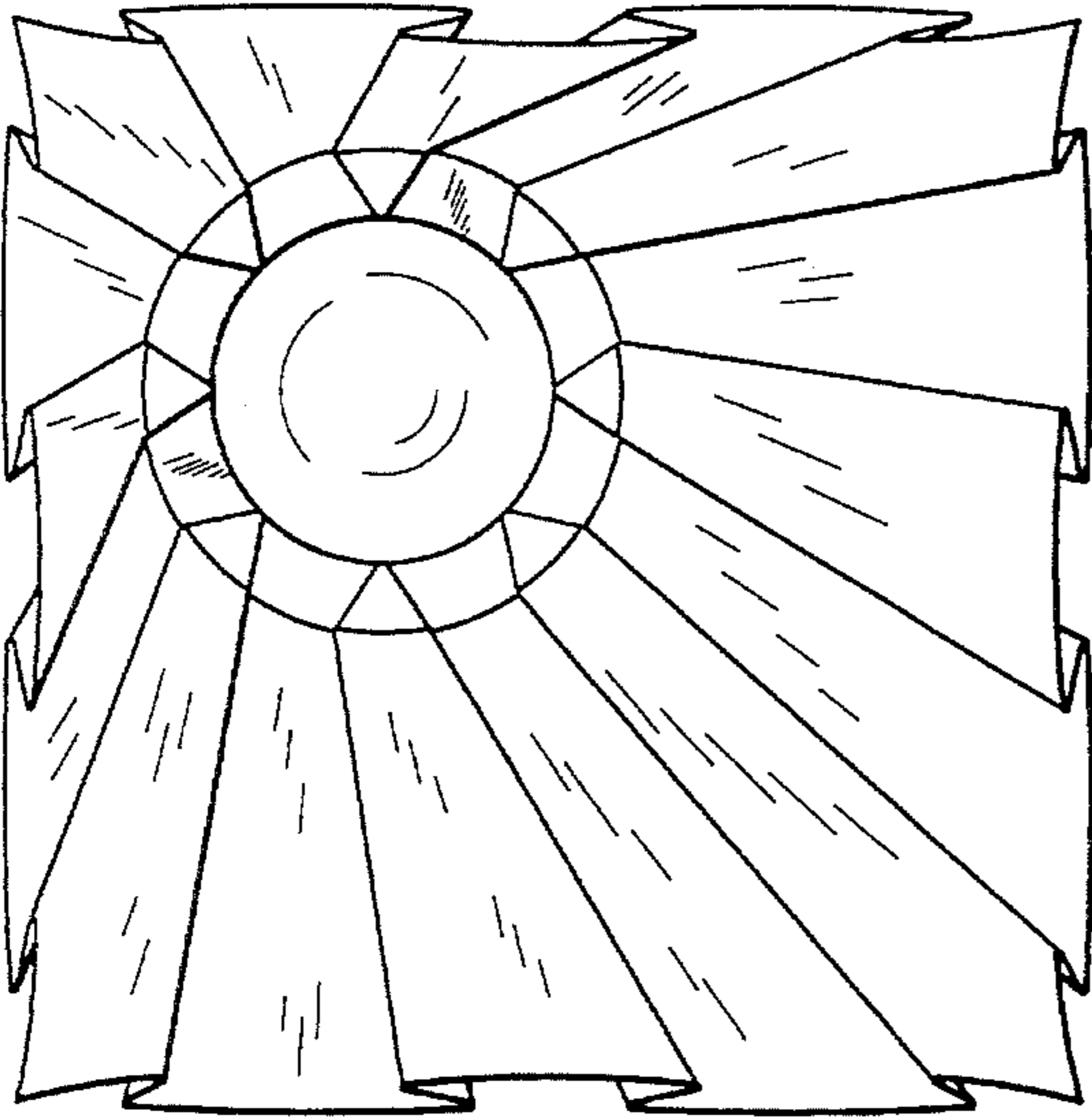

FIG. 7

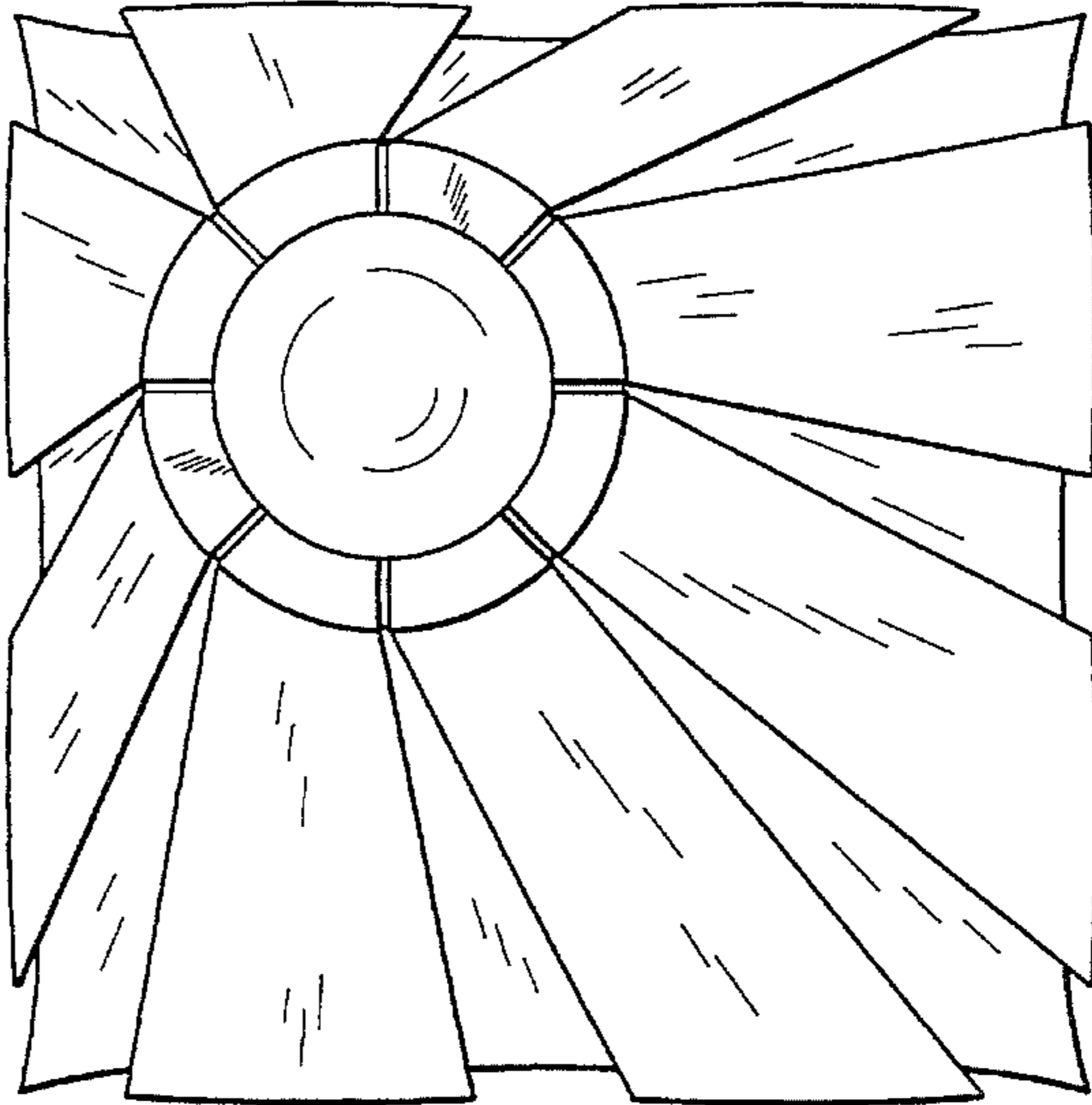

FIG. 8

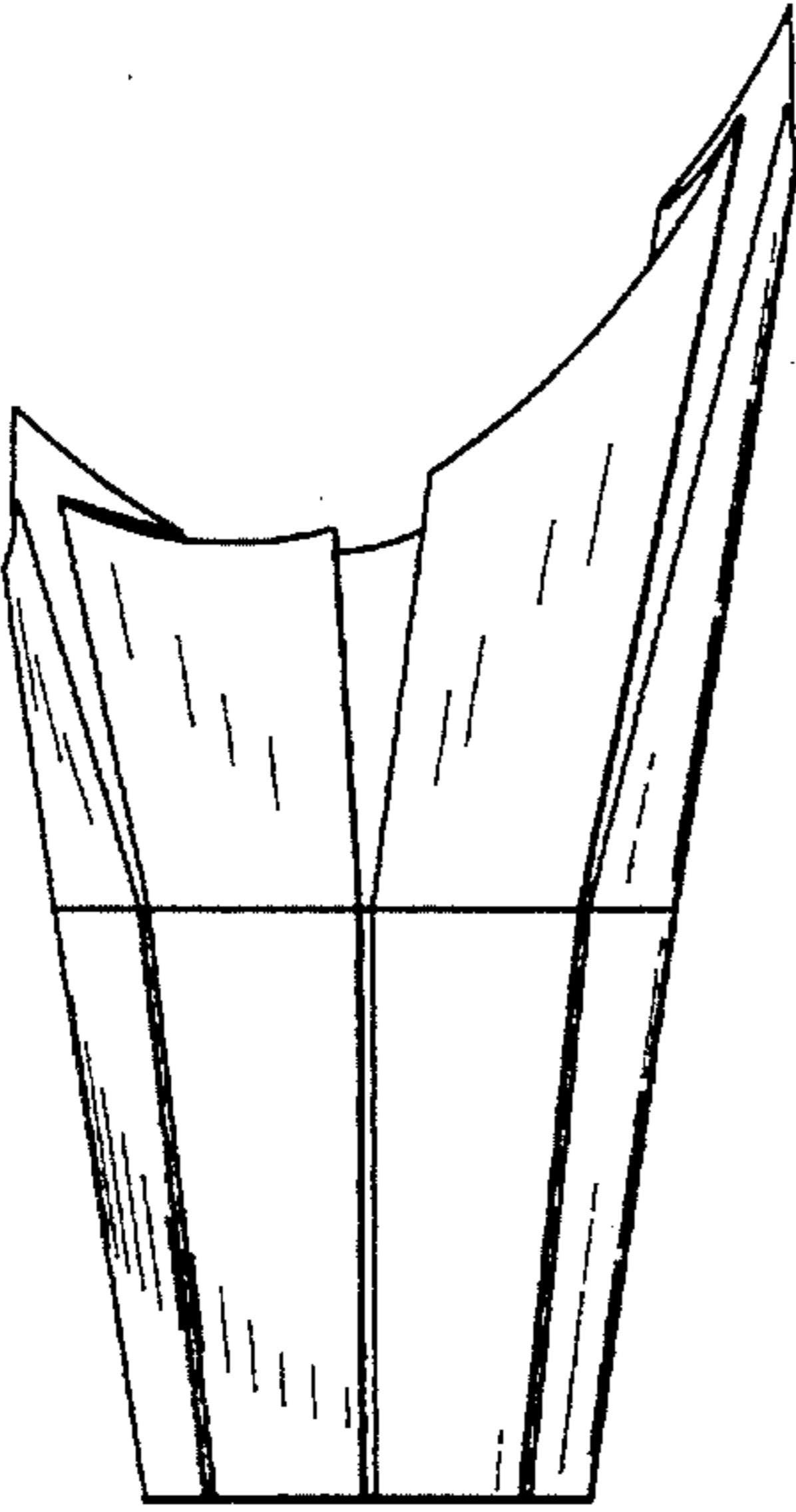

FIG. 9

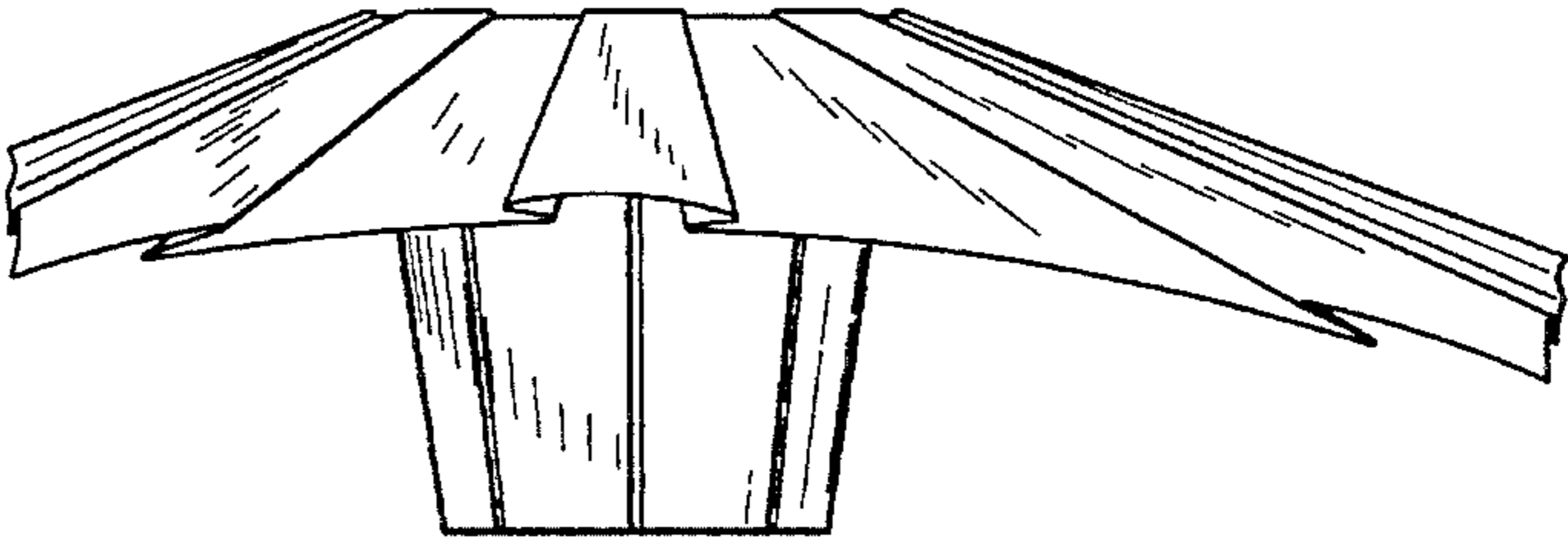

FIG. 10

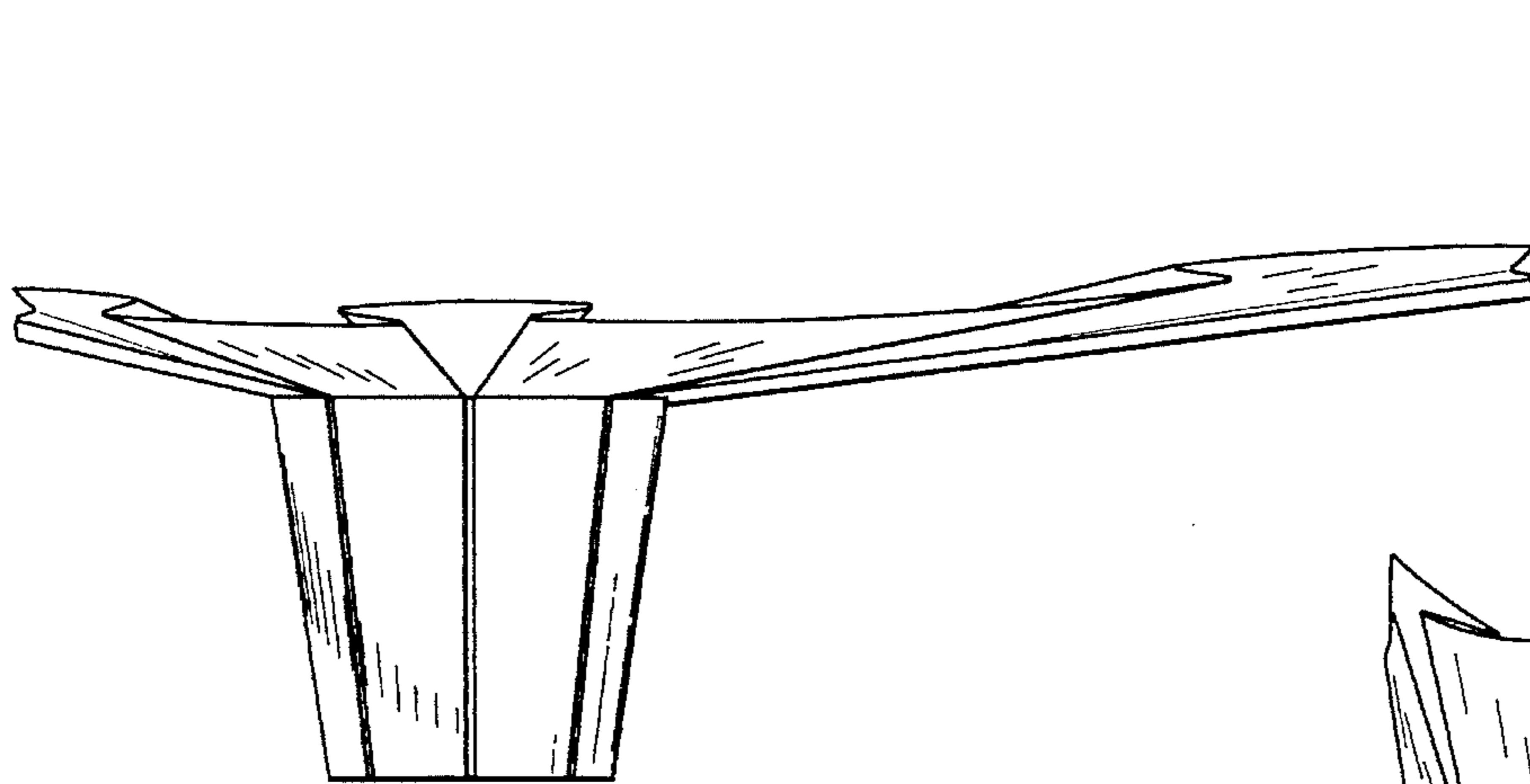

FIG. 11

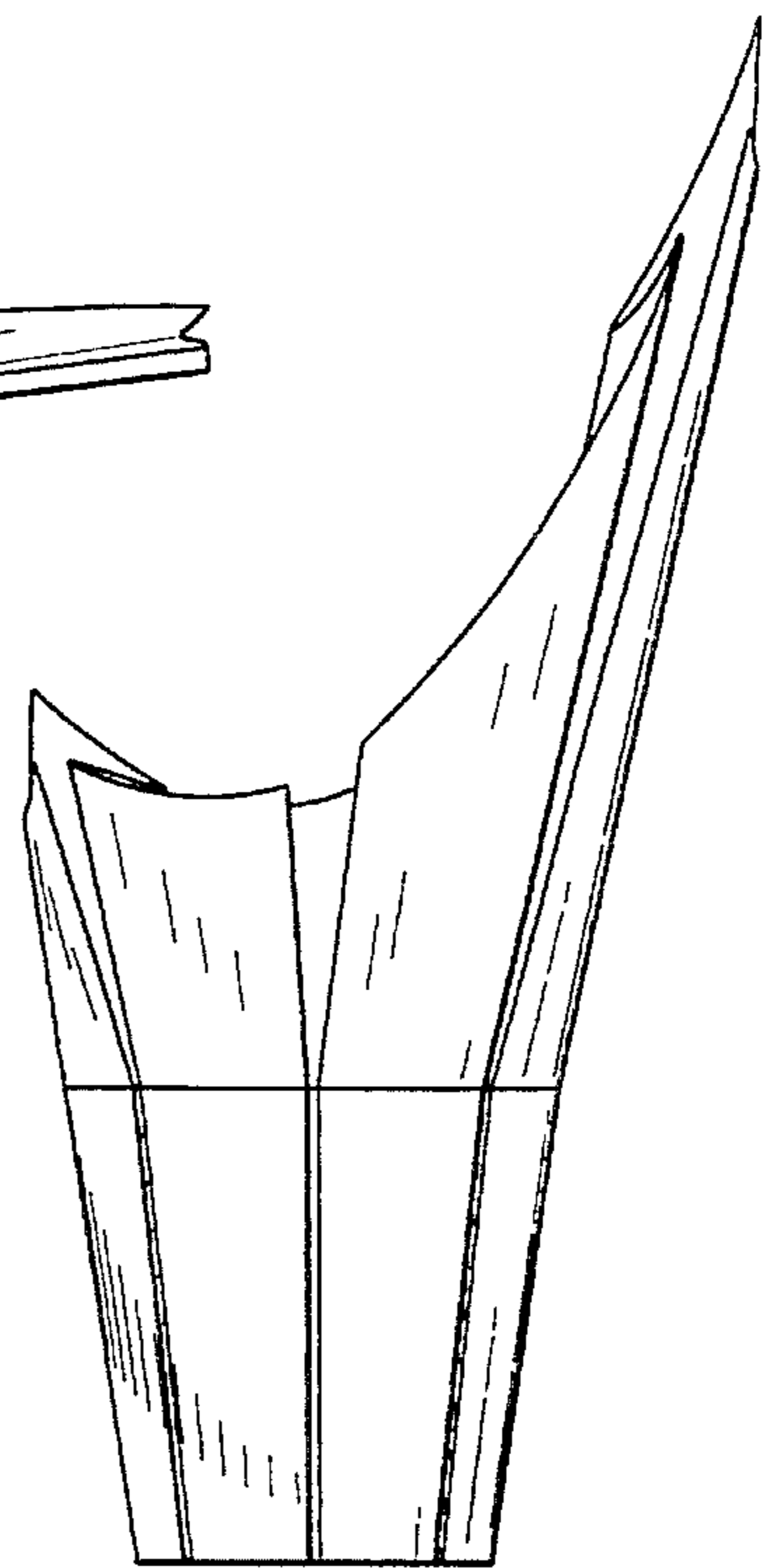

FIG. 12

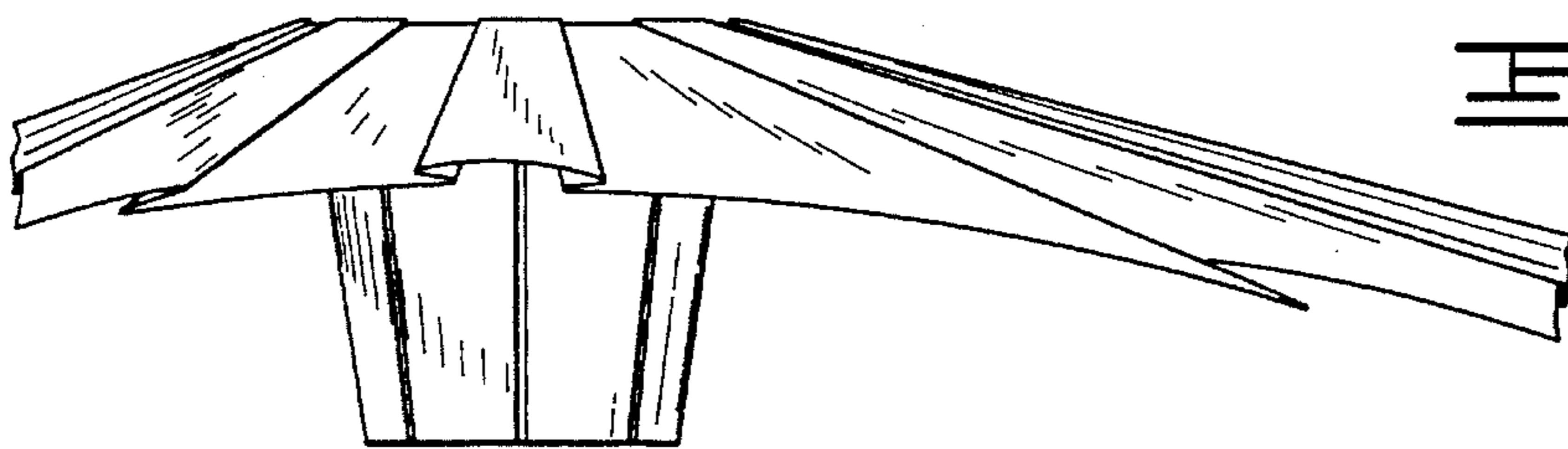

FIG. 13

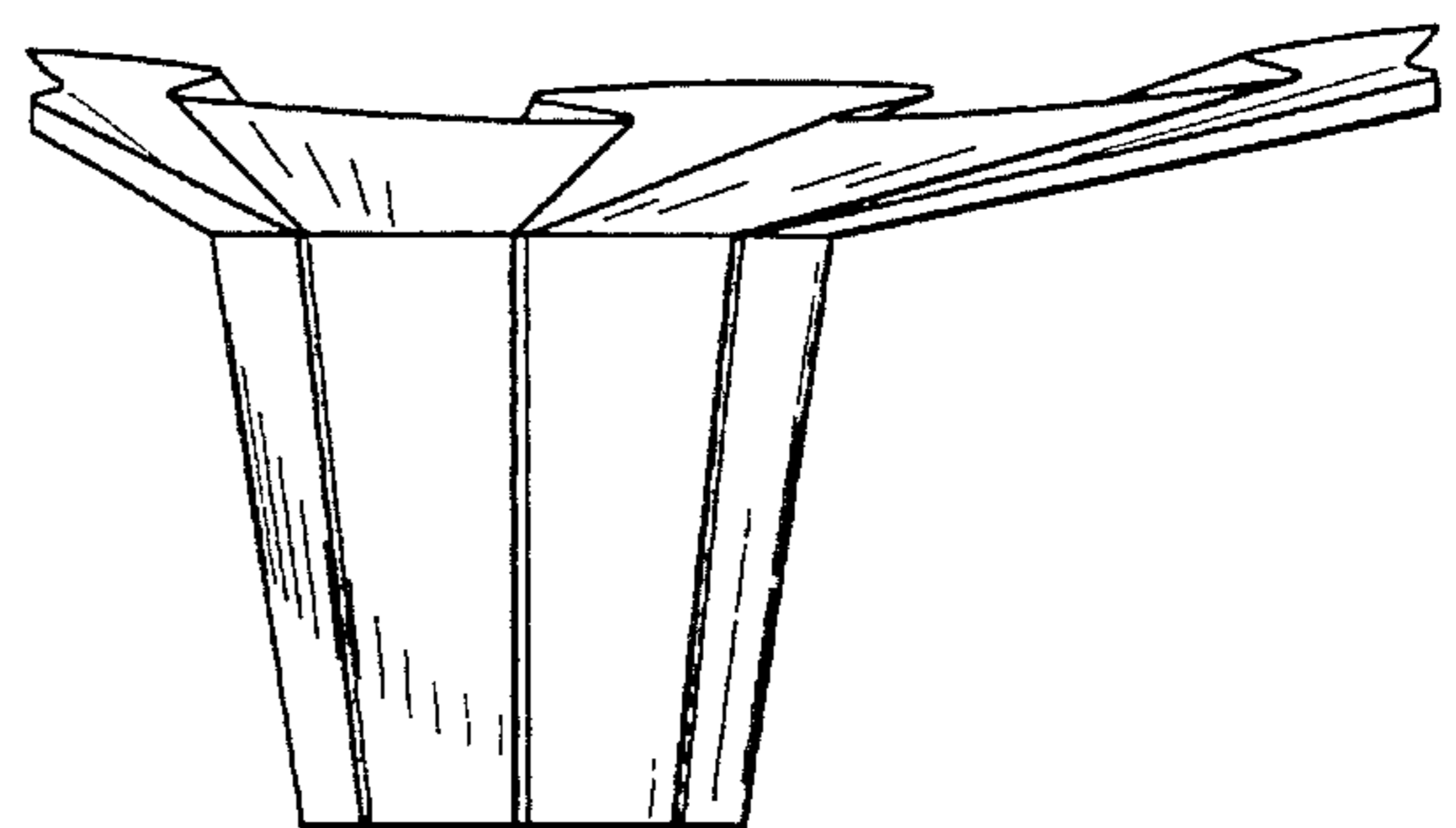

FIG. 14

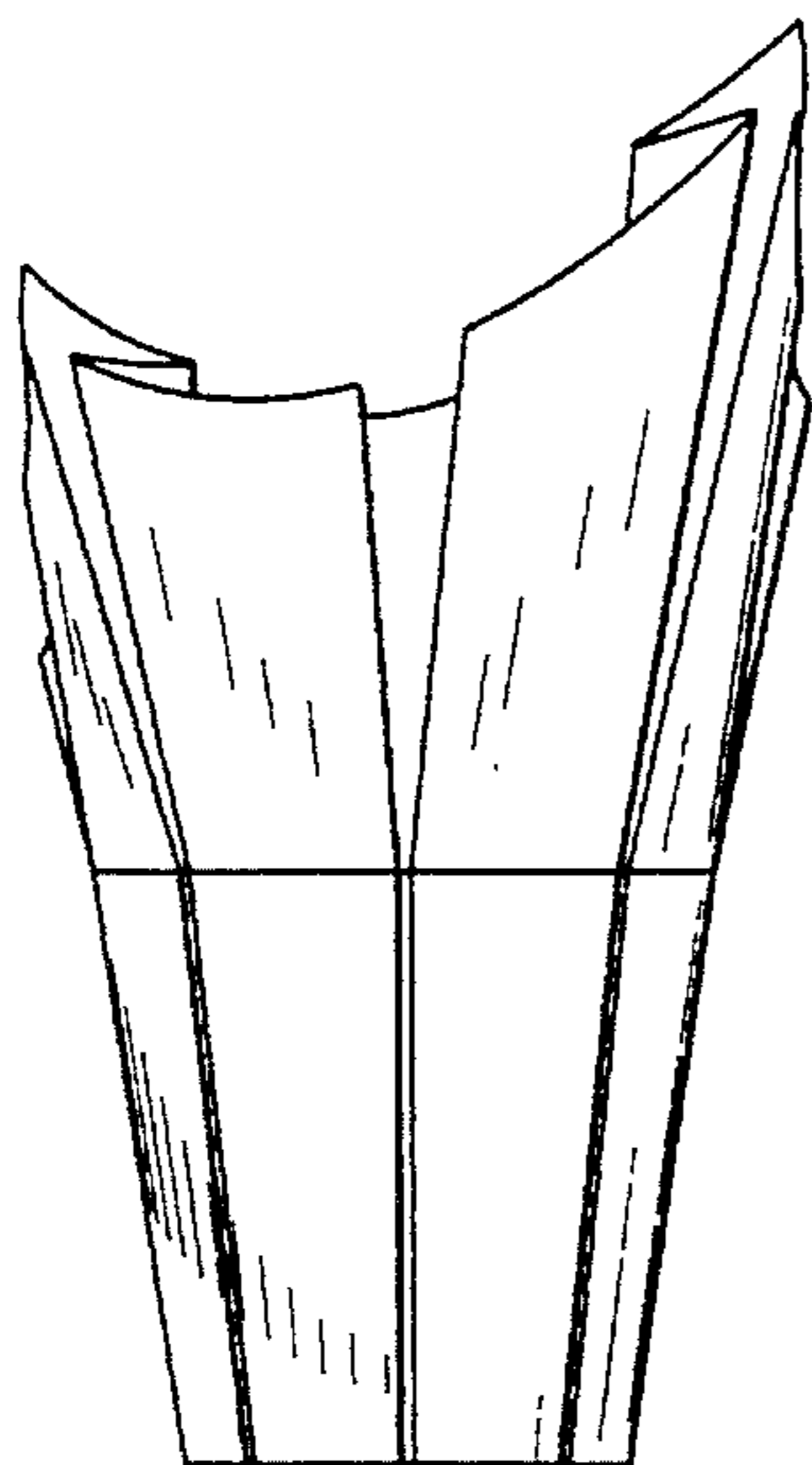

FIG. 15

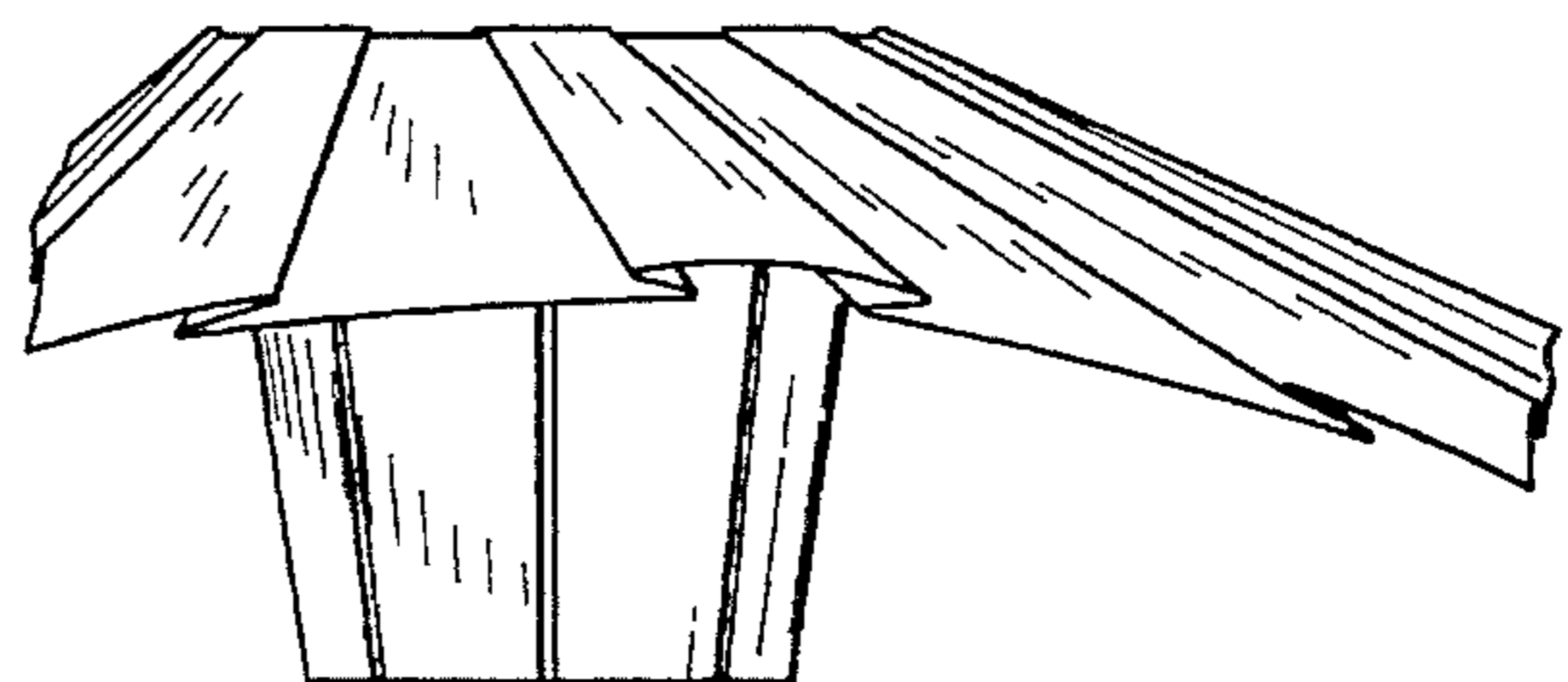

FIG. 16

UNITED STATES PATENT AND TRADEMARK OFFICE
CERTIFICATE OF CORRECTION

PATENT NO. : Des. 362,823
DATED : October 3, 1995
INVENTOR(S) : Weder et al.

It is certified that error appears in the above-identified patent and that said Letters Patent is hereby corrected as shown below:

Title page under 'Related U.S. Application Data',
item [63], line 2, please delete "abandoned", and
substitute therefor --now U.S. Patent No. Des.
365,302--.

Title page under 'Related U.S. Application Data',
item [63], lines 3-4, after '411,249, Sep. 22,
1989,', please insert --now U.S. Serial No. Des.
358,113--.

Page 2, under 'U.S. Patent Documents', line 40, please
delete "D. 304,407", and substitute therefor
--D. 302,407--.

Page 2, under 'OTHER PUBLICATIONS', line 15, please
delete "glass", and substitute therefor --Glass--.

Page 2, under 'OTHER PUBLICATIONS', line 15, please
delete "1972", and substitute therefor --1971--.

Signed and Sealed this
Fourth Day of June, 1996



BRUCE LEHMAN

Commissioner of Patents and Trademarks

Attest:

Attesting Officer