



US00D362761S

United States Patent [19]

[11] Patent Number: **Des. 362,761**

Hood

[45] Date of Patent: ****Oct. 3, 1995**

[54] **MULTIPLE DESK AND CABINET TOWER UNIT**

3,437,390 4/1969 Evans 312/196 X
4,936,228 6/1990 Capo-Bianco 312/196 X

[75] Inventor: **Christopher T. Hood**, Boxborough, Mass.

Primary Examiner—Carmen H. Vales-Lado
Attorney, Agent, or Firm—Dirk Brinkman; Ronald C. Hudgens; Arthur W. Fisher

[73] Assignee: **Digital Equipment Corporation**, Maynard, Mass.

[57] CLAIM

[**] Term: **14 Years**

The ornamental design for a multiple desk and cabinet tower unit, as shown and described.

[21] Appl. No.: **13,004**

DESCRIPTION

[22] Filed: **Sep. 15, 1993**

[52] U.S. Cl. **D6/397; D6/423**

[58] Field of Search D6/419-428, 396, D6/397, 399, 477-479, 474; 312/194-196; 108/59, 60, 64

FIG. 1 is a front perspective view of the multiple desk and cabinet tower unit embodying my design;
FIG. 2 is a front view thereof;
FIG. 3 is a back view thereof;
FIG. 4 is a left view thereof;
FIG. 5 is a right view thereof;
FIG. 6 is a top view thereof;
FIG. 7 is a bottom view thereof;
FIG. 8 is a front perspective view of an alternate embodiment of the multiple desk and tower cabinet unit shown in FIG. 1; the opposite side of the center desk being a mirror image thereof, and the opposite side of the tower cabinet being identical thereto; and,
FIG. 9 is a rear perspective view thereof.

[56] References Cited

U.S. PATENT DOCUMENTS

D. 109,531	5/1938	Lea	D6/399
D. 115,850	7/1939	Greenfield	D6/426
D. 157,781	3/1950	Pahlmann	D6/397
D. 213,974	4/1969	Provost	D6/427
D. 286,115	10/1986	Evans	D6/474 X
D. 297,987	10/1988	Borsos	D6/420
D. 334,490	4/1993	Johnson	D6/397 X
D. 336,725	6/1993	Emanuel	D6/477 X

1 Claim, 9 Drawing Sheets

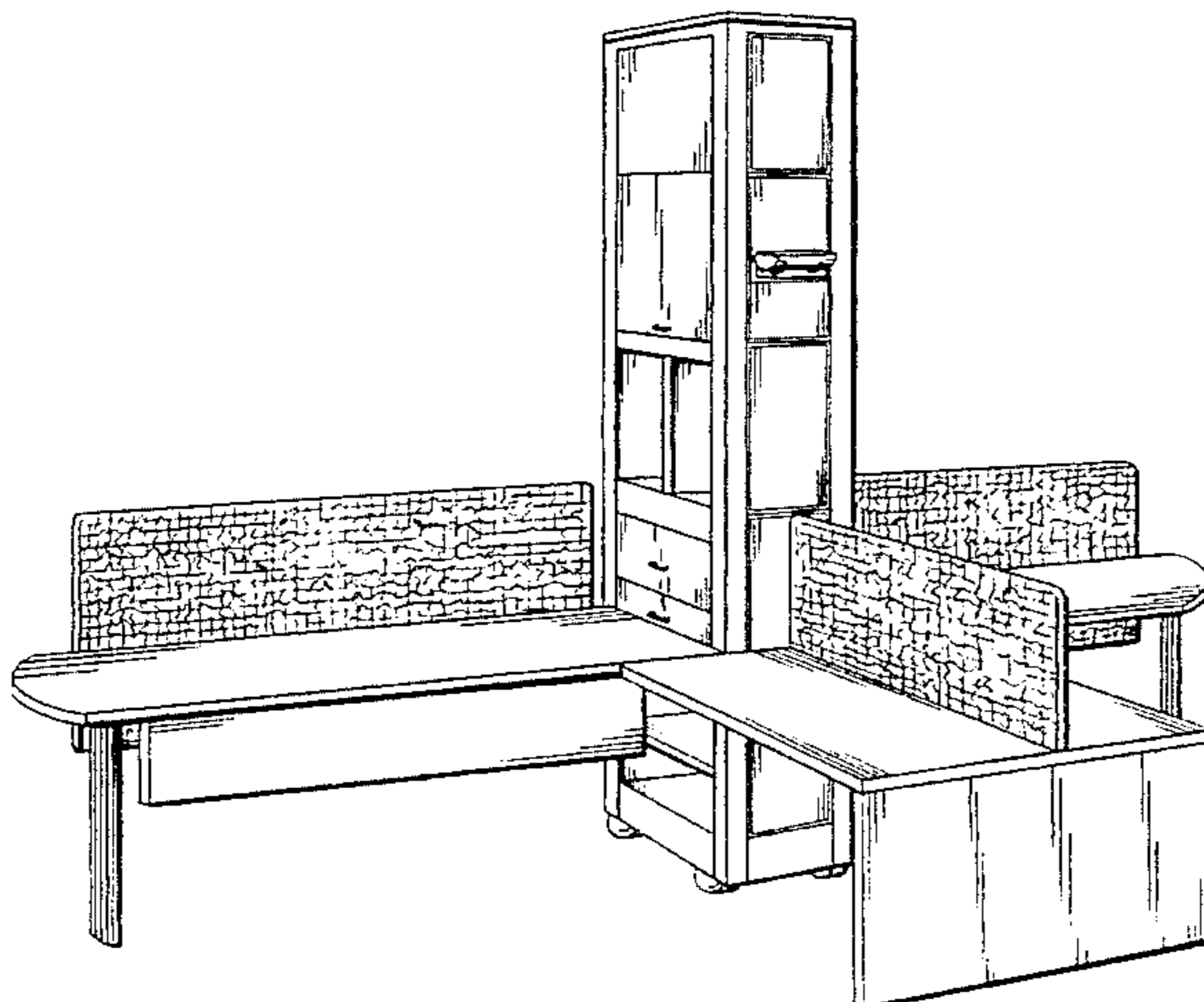
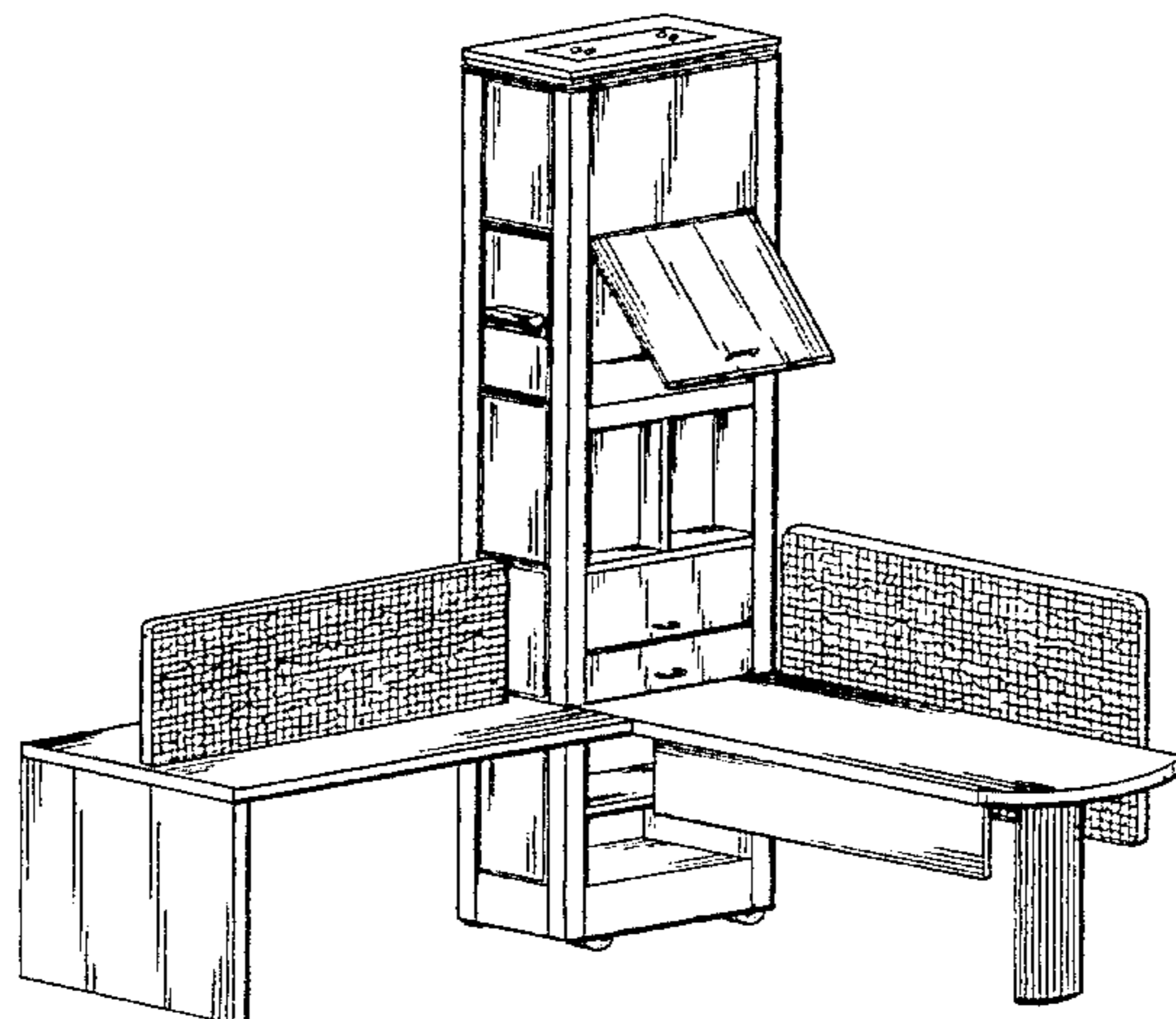

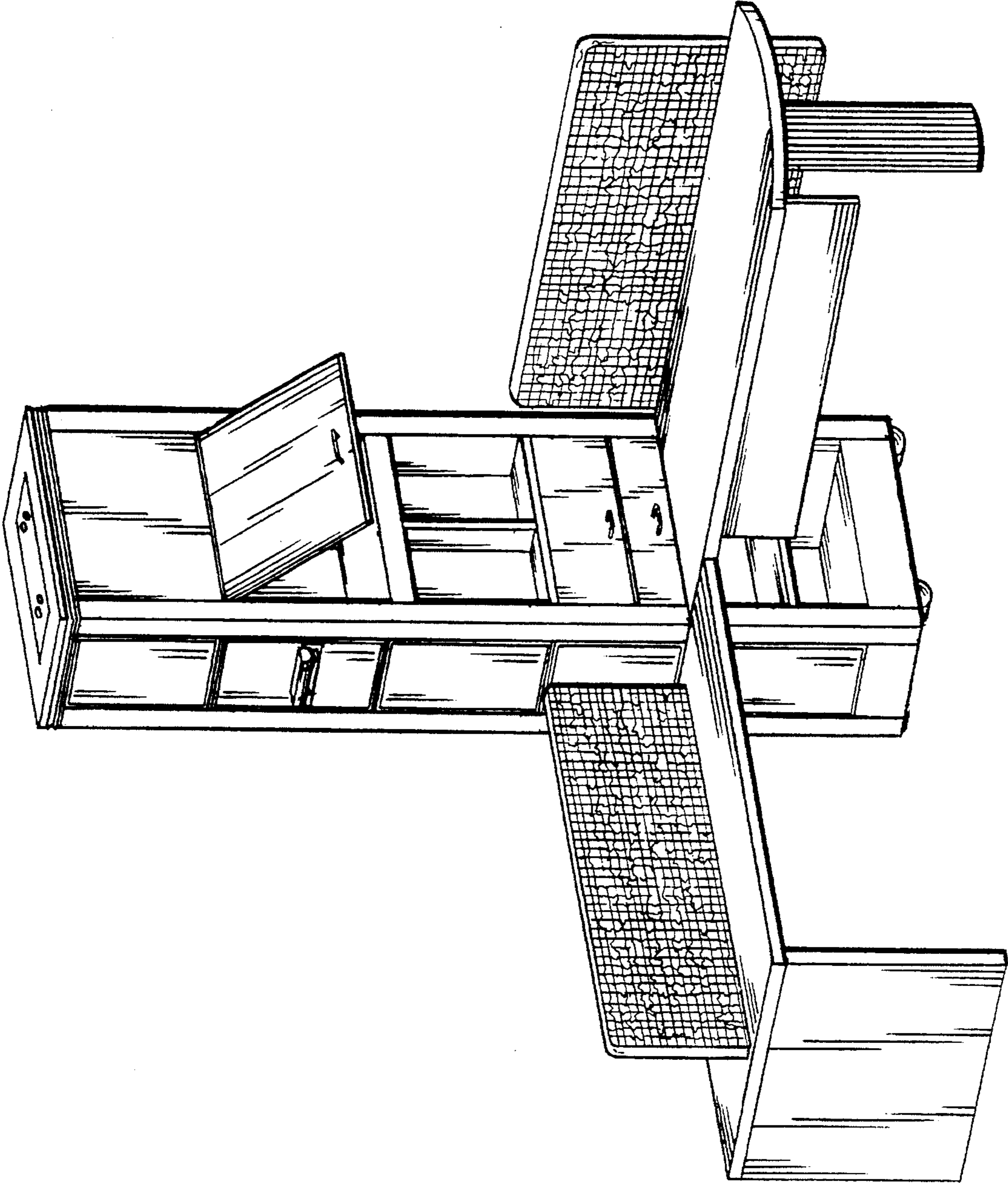

FIG. 1

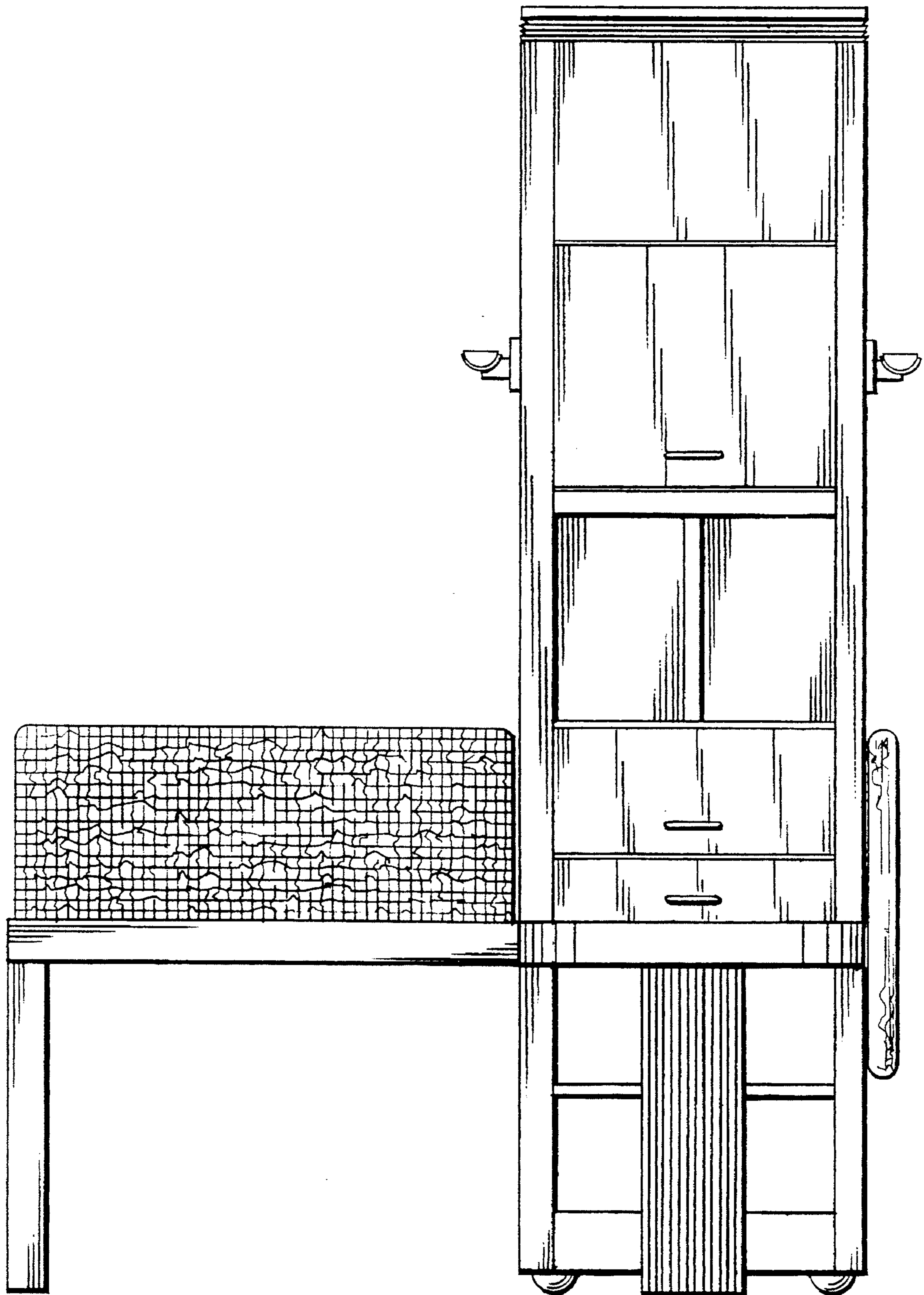

FIG. 2

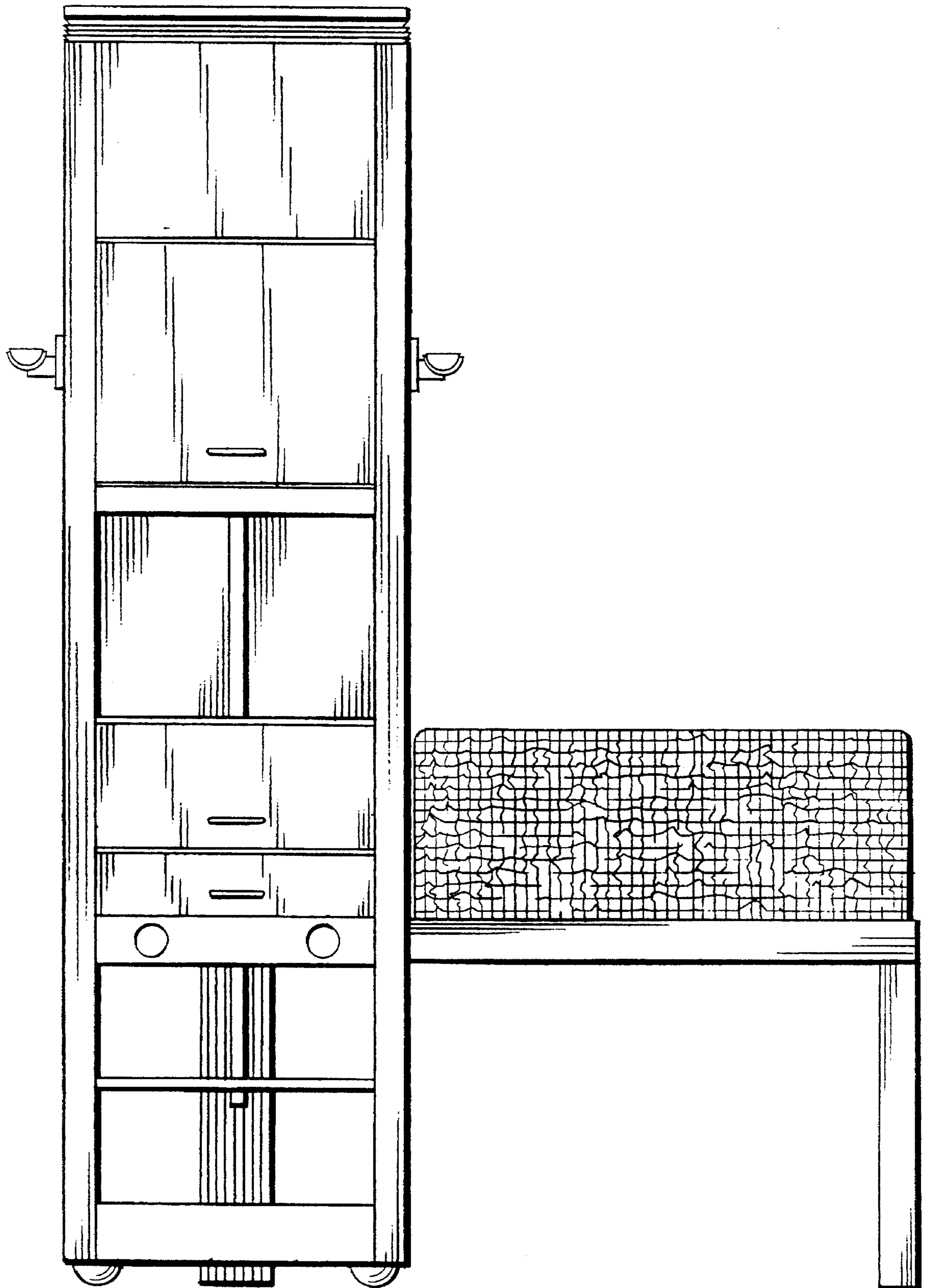

FIG. 3

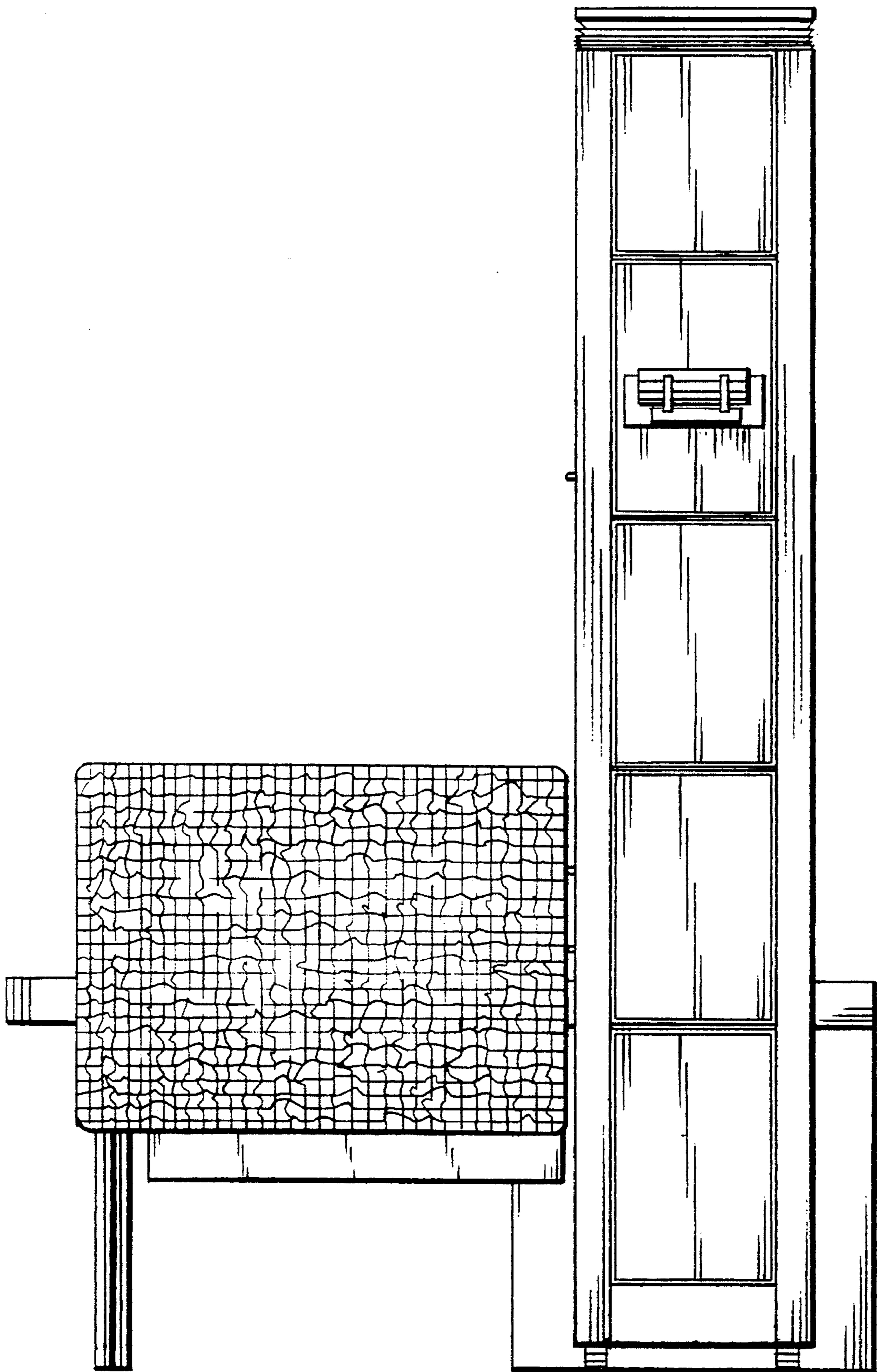

FIG. 4

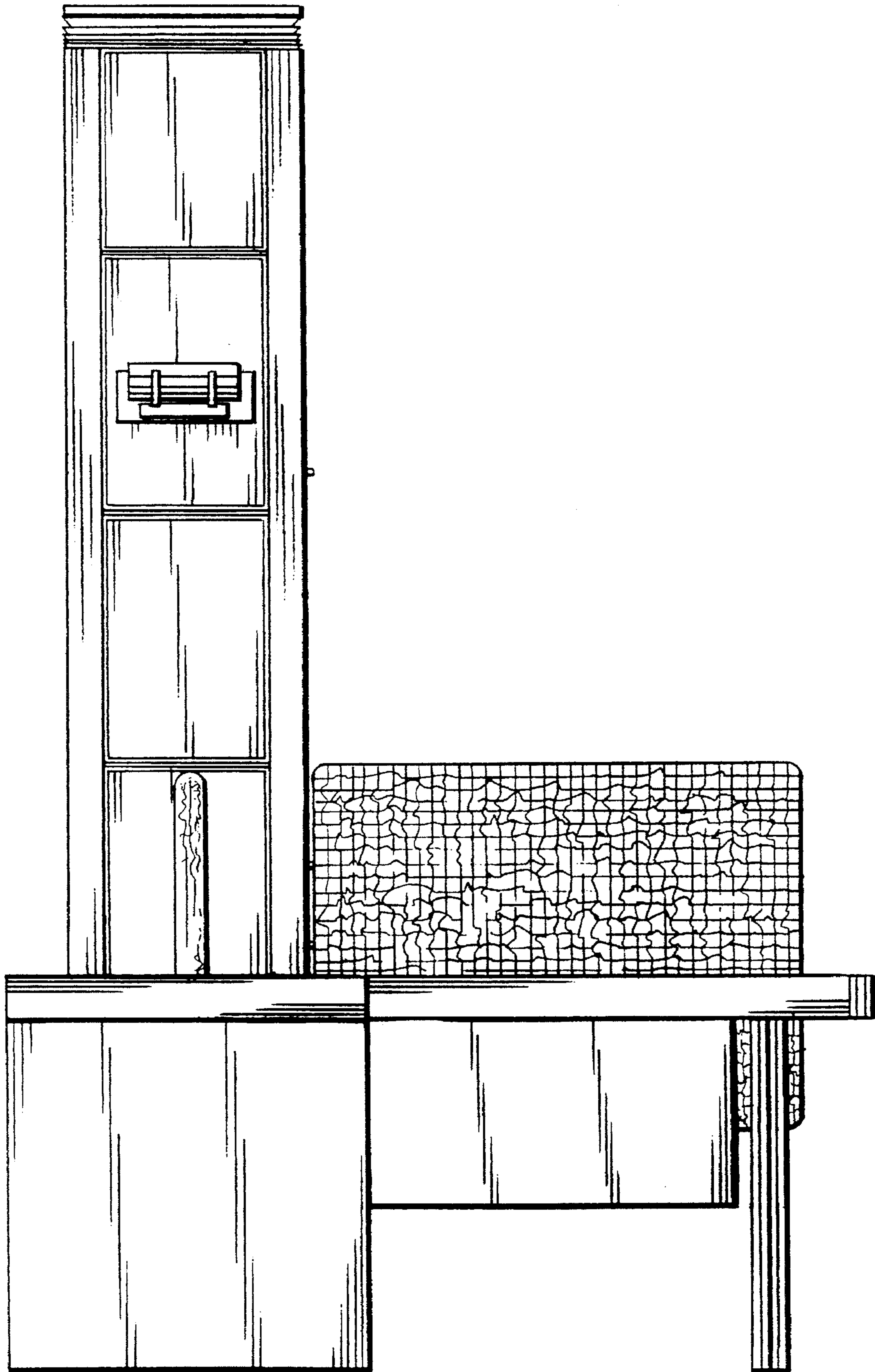

FIG. 5

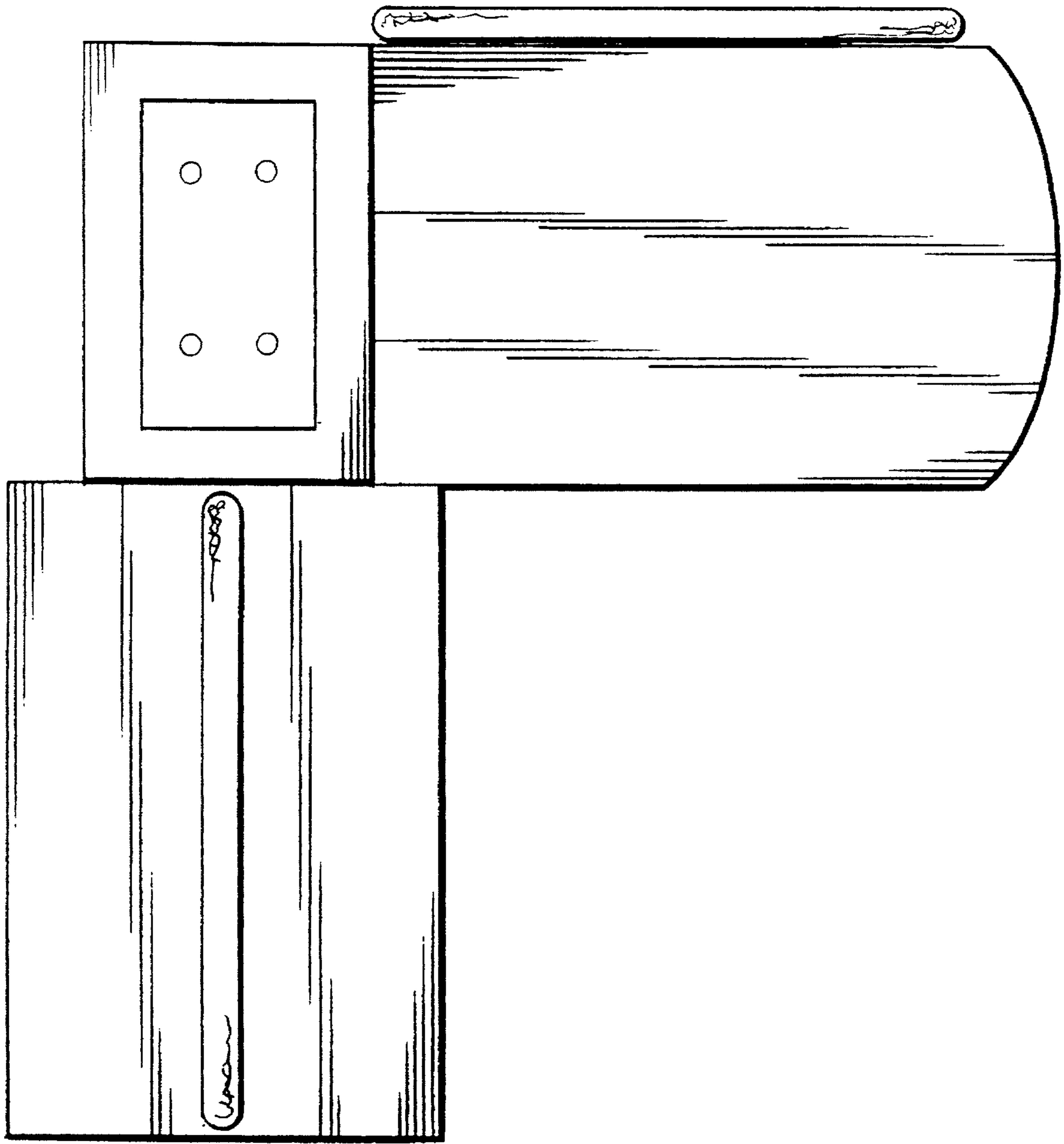

FIG. 6

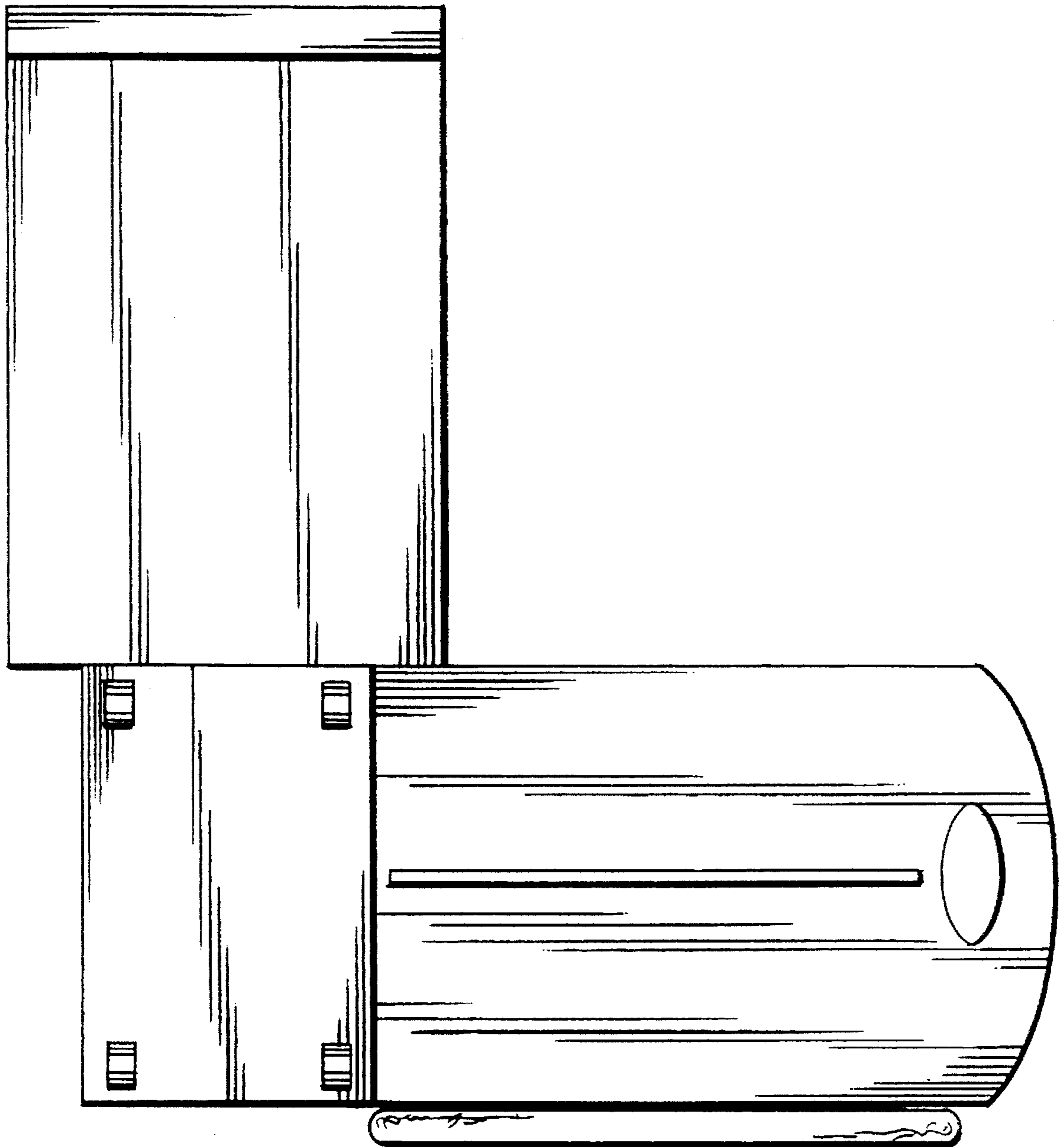

FIG. 7

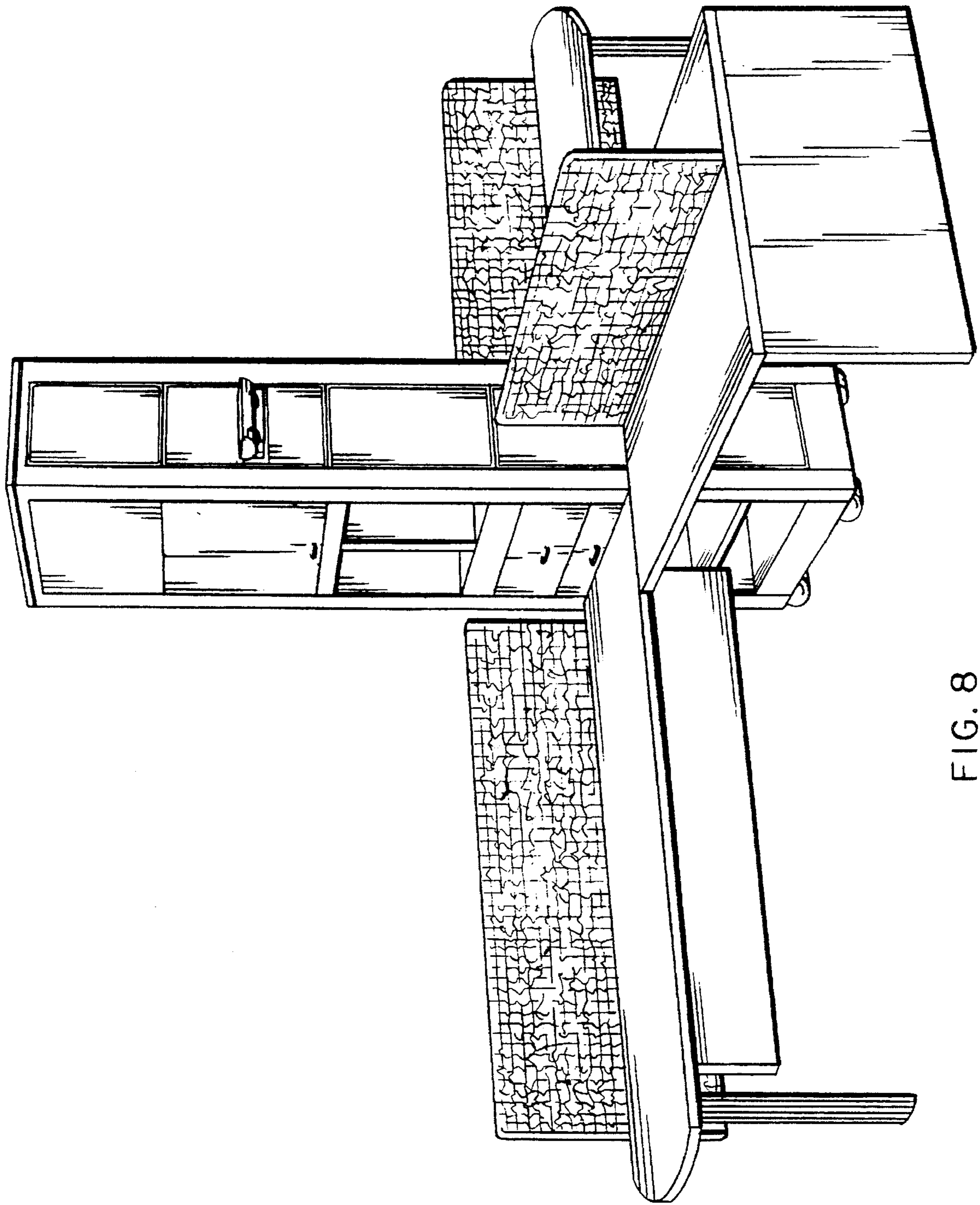

FIG. 8

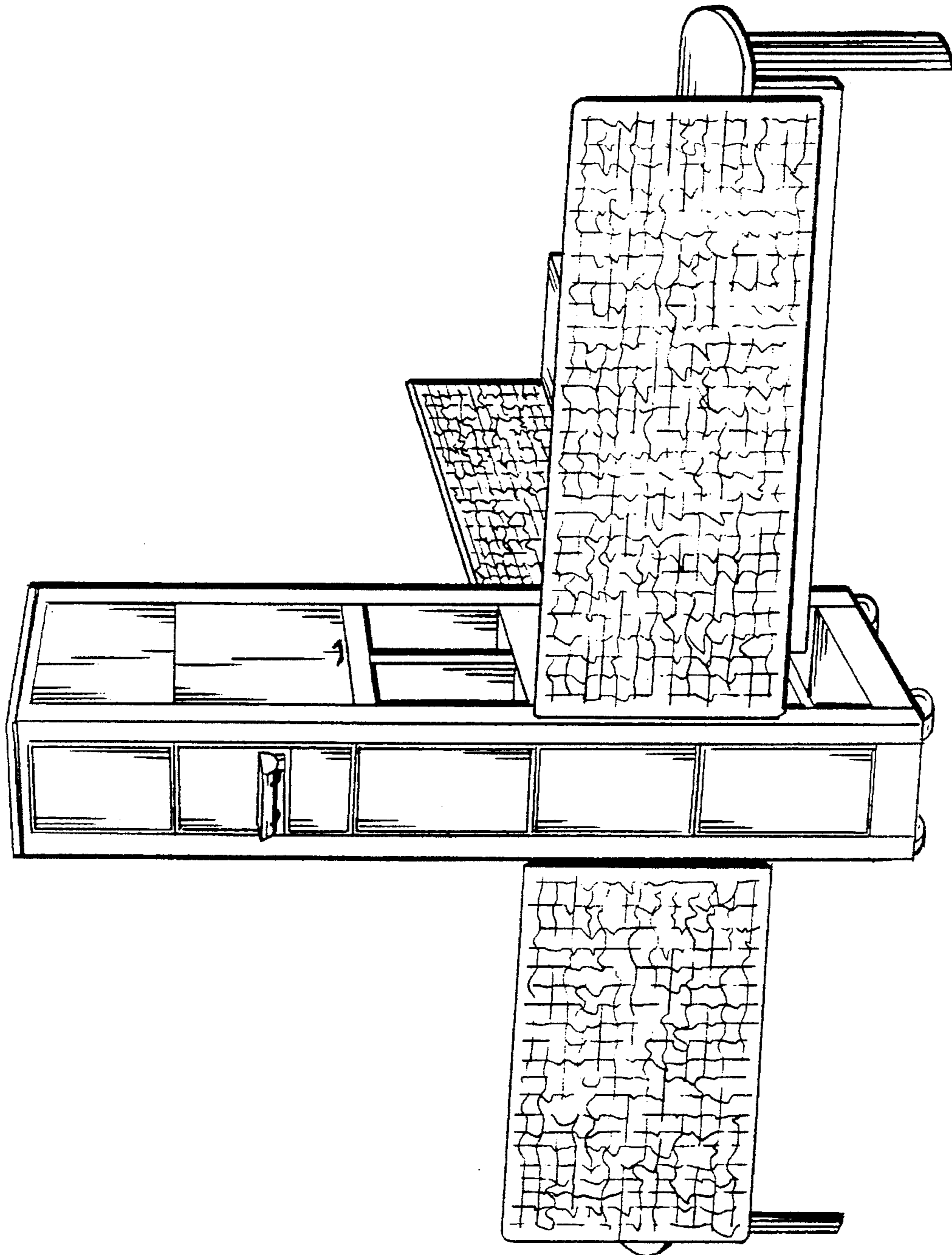

FIG. 9