



US00D362655S

United States Patent [19]

[11] **Patent Number:** **Des. 362,655**

Bain

[45] **Date of Patent:** ****Sep. 26, 1995**

[54] **FIRE LOG**

“Far Beyond the Ordinary Firelog” ©1993 Pine Mt. Corp.

[75] Inventor: **Stephen E. Bain**, Hudson, Ohio

Primary Examiner—Brian N. Vinson

[73] Assignee: **Forest Technology Corporation**, Akron, Ohio

Assistant Examiner—Robin V. Taylor

Attorney, Agent, or Firm—Vickers, Daniels & Young

[**] Term: **14 Years**

[57] CLAIM

[21] Appl. No.: **16,668**

The ornamental design of a fire log, as shown and described.

[22] Filed: **Dec. 21, 1993**

DESCRIPTION

[52] U.S. Cl. **D13/100**

[58] Field of Search D13/100; D7/402, D7/46; 44/530, 532, 591

FIG. 1 is a perspective view of a fire log according to the present invention;

FIG. 2 is a side elevation view of the log, the opposite side being a mirror image;

FIG. 3 is a frontal elevation of the log shown in FIG. 1;

FIG. 4 is a top elevation of the log shown in FIG. 1;

FIG. 5 is a bottom elevation of the log shown in FIG. 1; and,

FIG. 6 is a top view of an alternative embodiment of the log, the difference residing in a provision of one channel instead of two.

[56] References Cited

U.S. PATENT DOCUMENTS

2,789,890	4/1957	Stevens	44/532
3,988,121	10/1976	Leveskis	44/530
4,243,394	1/1981	Kincaid	44/14
4,560,389	12/1985	Steibel	D13/100
4,883,498	11/1989	MacIsaac	44/532

OTHER PUBLICATIONS

Photograph “A” showing a Conros fire log (in Public use or on sale prior to Dec. 1993).

Photograph “B” showing a Conros fire log (in public use or on sale prior to Dec. 1993).

1 Claim, 1 Drawing Sheet

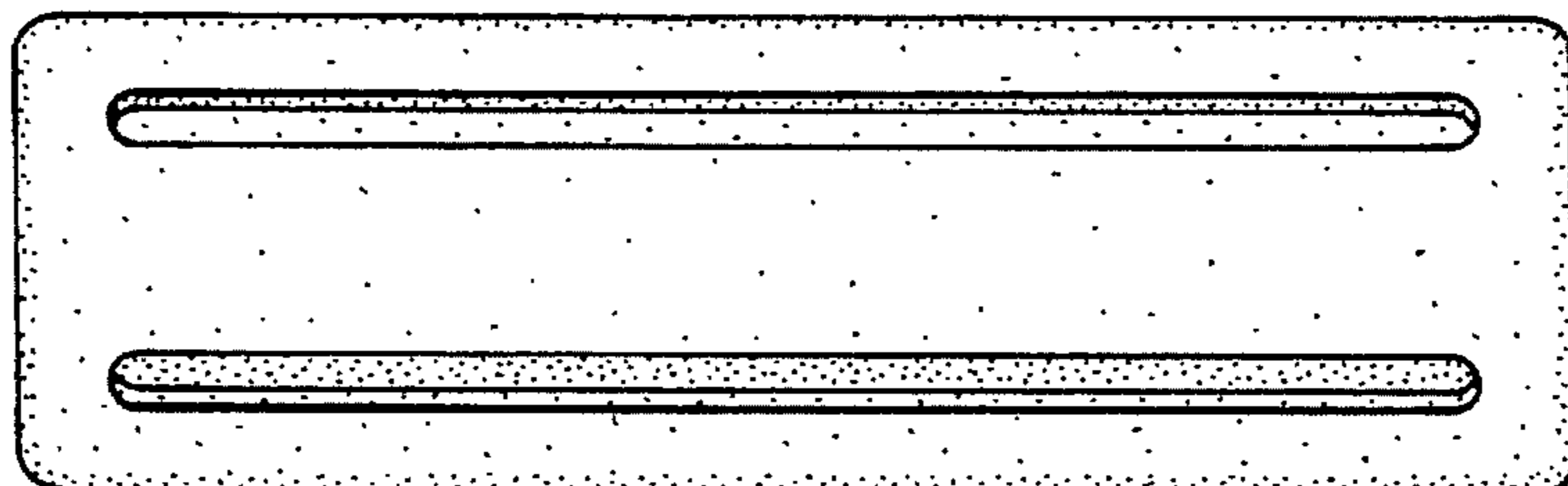
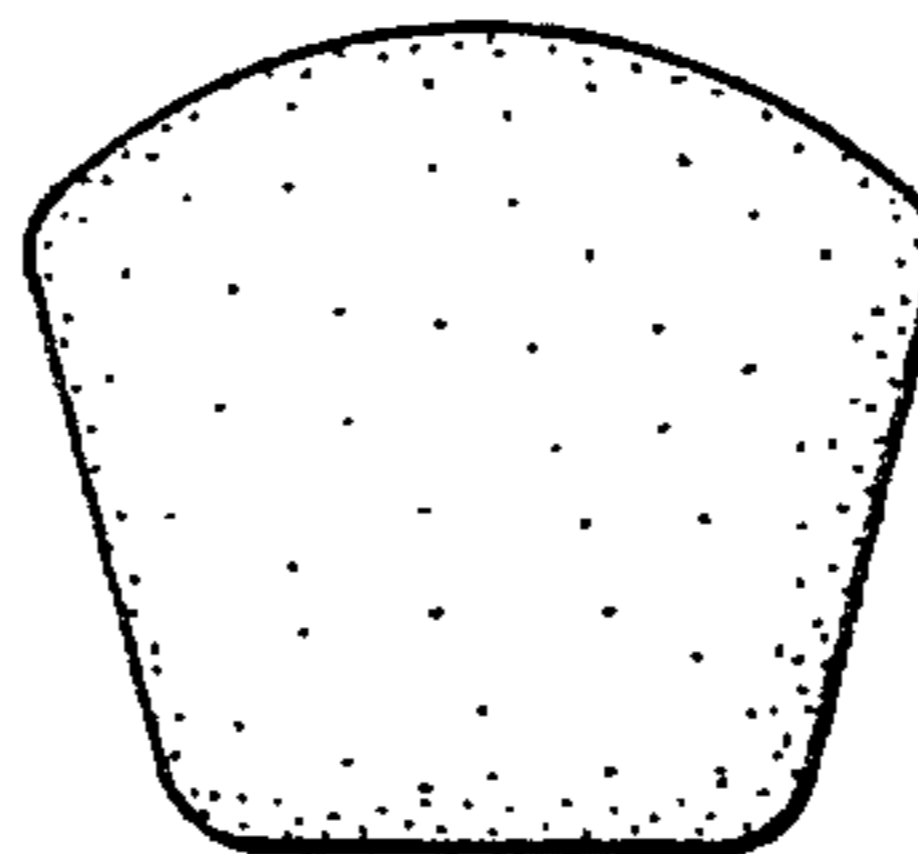
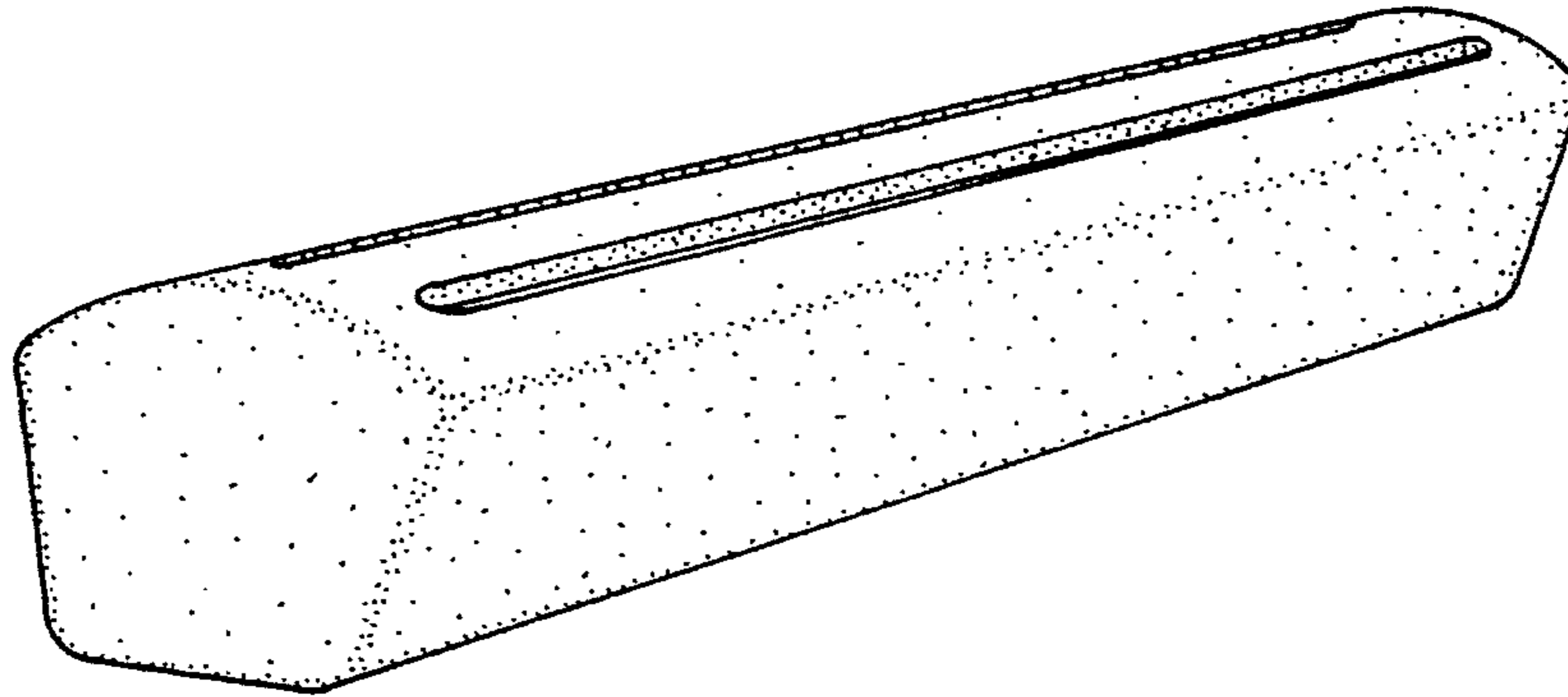

FIG. 1

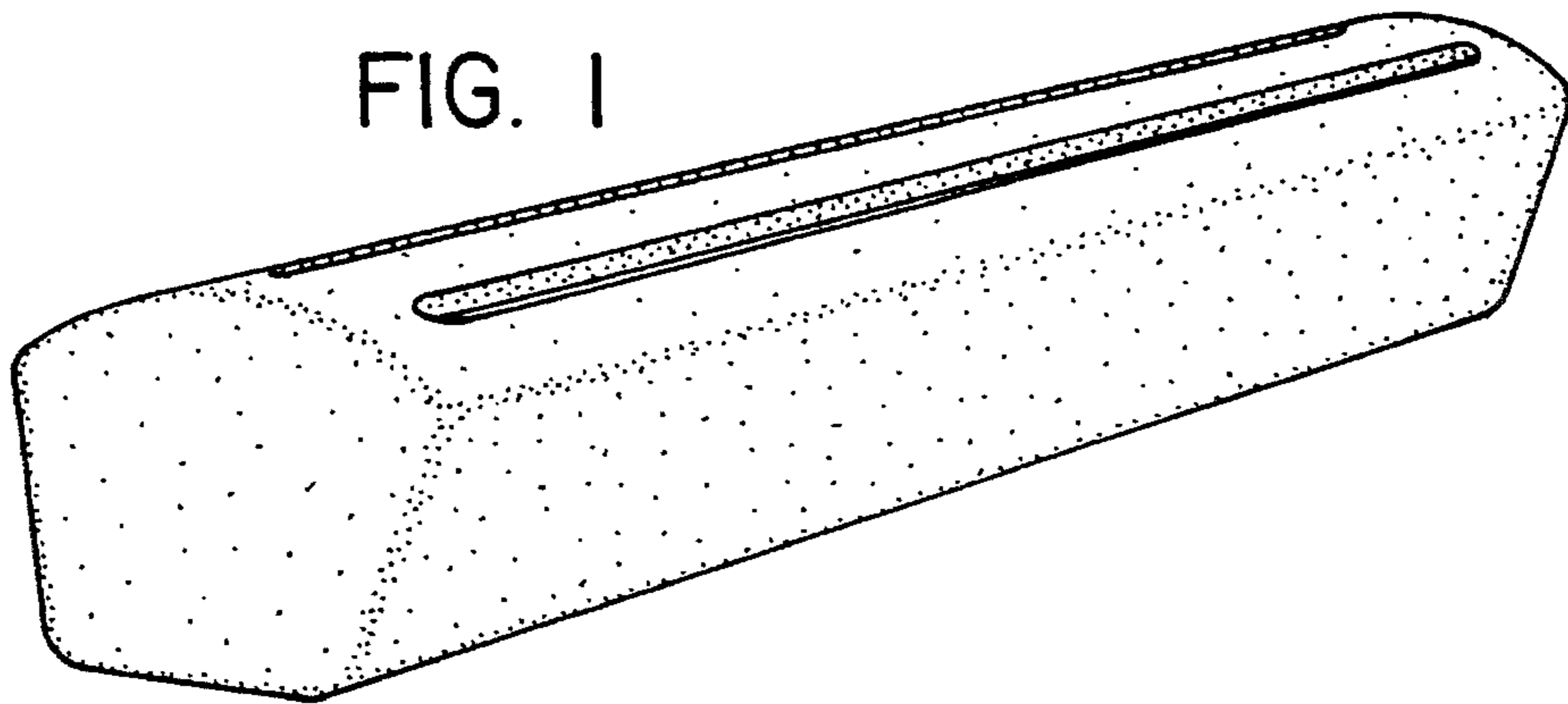

FIG. 2

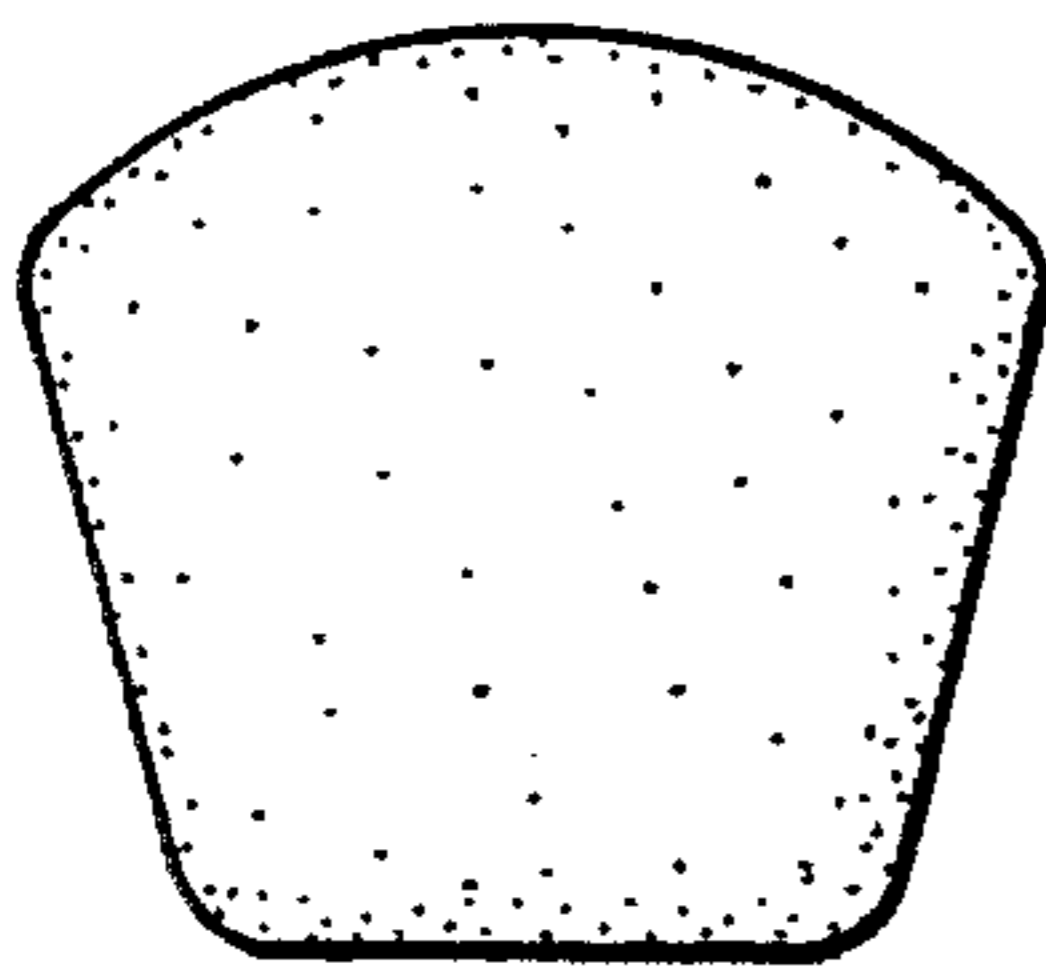

FIG. 3

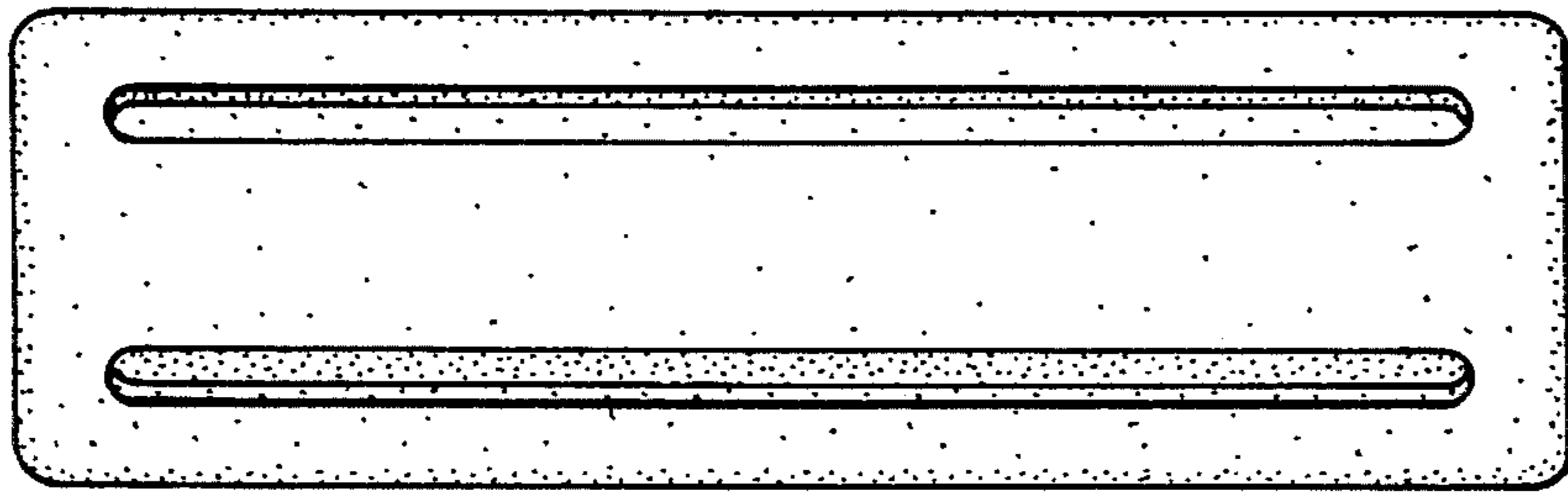
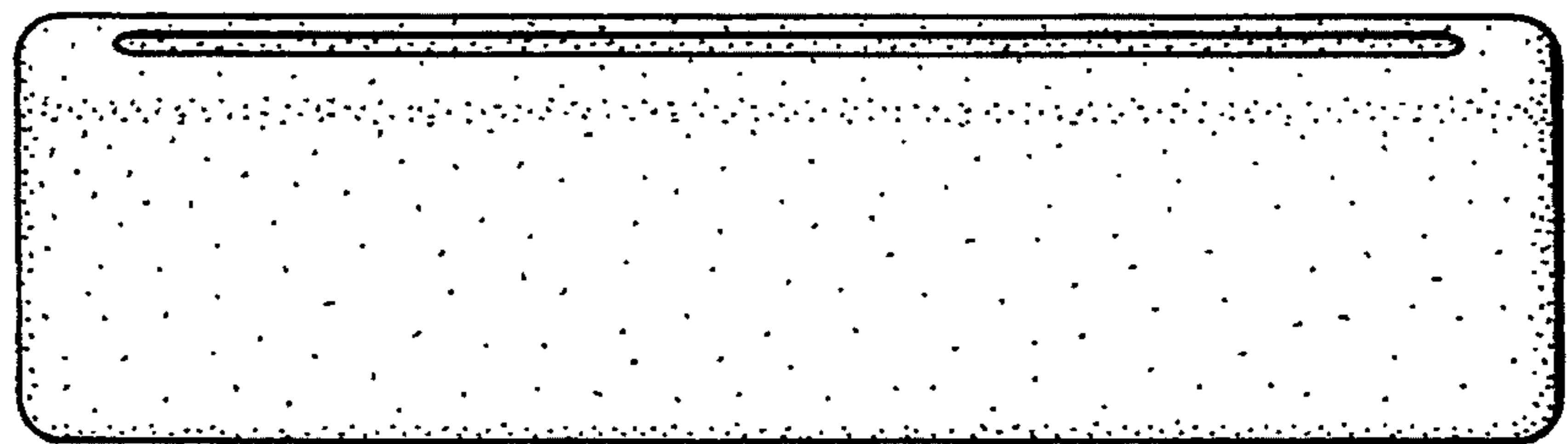

FIG. 4

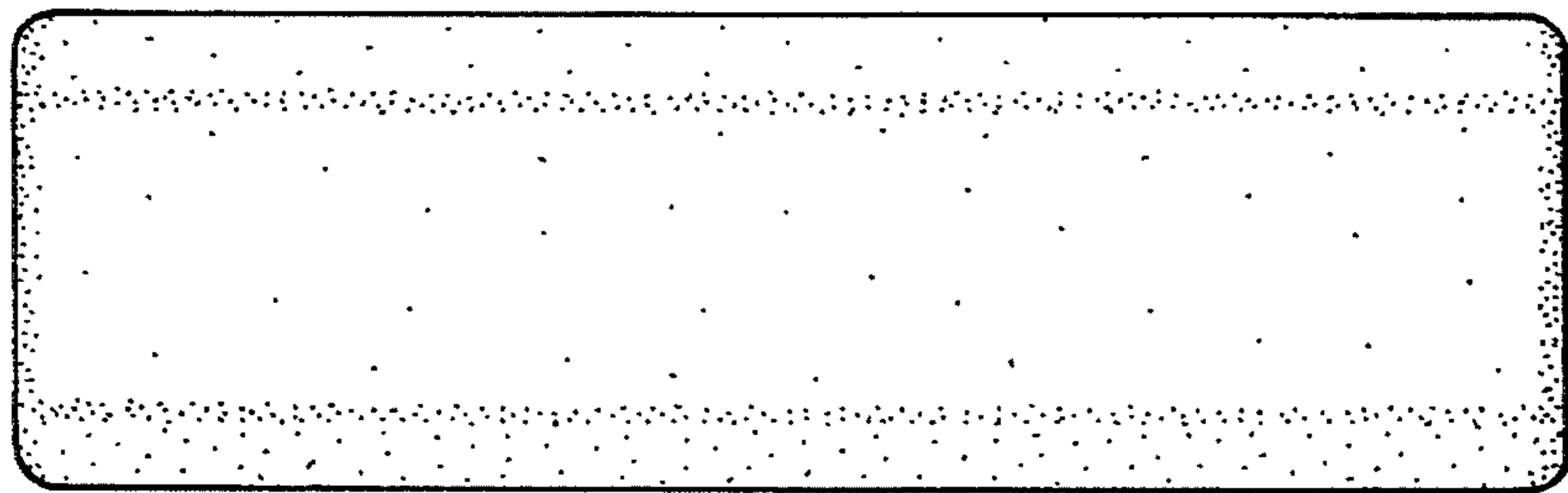

FIG. 5

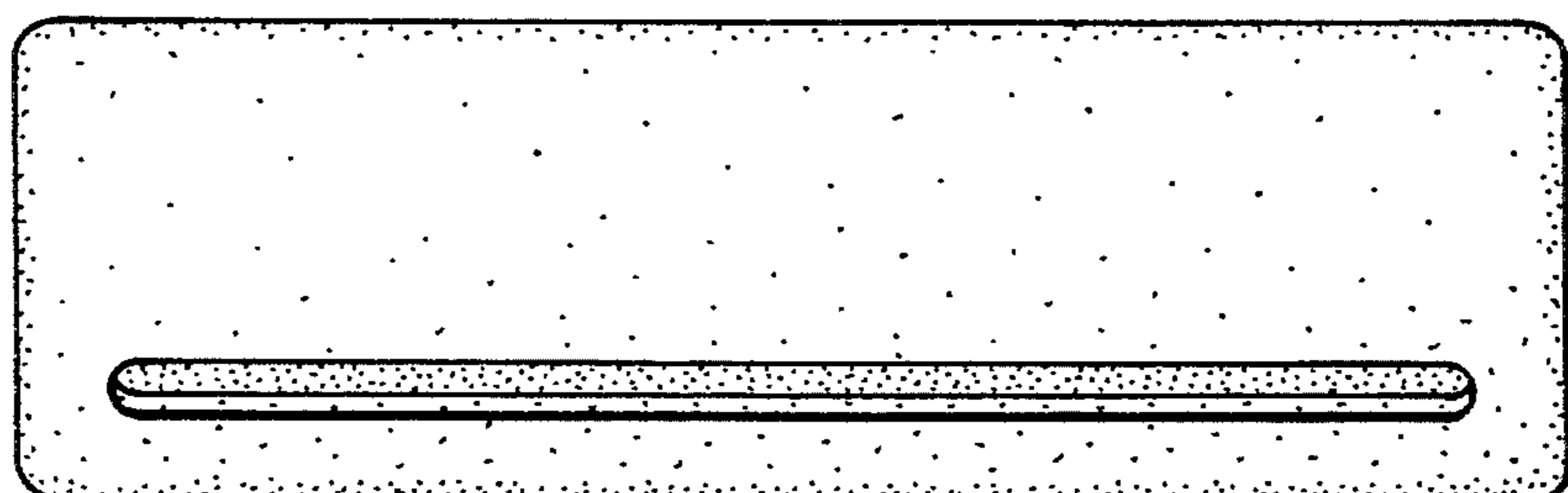

FIG. 6