



US00D362634S

# United States Patent [19] Bulgari

[11] Patent Number: **Des. 362,634**  
[45] Date of Patent: **\*\*Sep. 26, 1995**

[54] **WATCH**  
[75] Inventor: **Paolo Bulgari**, Rome, Italy  
[73] Assignee: **Bulgari Time (Switzerland) S.A.**,  
Neuchatel, Switzerland  
[\*\*] Term: **14 Years**  
[21] Appl. No.: **17,987**  
[22] Filed: **Jan. 26, 1994**  
[30] **Foreign Application Priority Data**  
Jul. 27, 1993 [WO] WIPO ..... DM/026813  
[52] U.S. Cl. .... **D10/39; D10/30**  
[58] Field of Search ..... D10/1-40, 122-132;  
368/280-282, 276-277, 285

D. 320,358 10/1991 Bulgari ..... D10/32  
D. 329,612 9/1992 Hysek ..... D10/30  
D. 350,288 9/1994 Giardiello ..... D10/30  
D. 351,559 10/1994 Helleu ..... D10/39  
D. 352,470 11/1994 Besson ..... D10/39  
D. 3,290,022 9/1992 Bulgari ..... D10/39

*Primary Examiner*—Nelson C. Holtje  
*Attorney, Agent, or Firm*—Barnes, Kisselle, Raisch, Choate,  
Whittemore & Hulbert

### [57] CLAIM

The ornamental design for a watch, as shown.

### DESCRIPTION

FIG. 1 is a plan view of a watch showing my new design;  
FIG. 2 is a view taken from the right in FIG. 1;  
FIG. 3 is a rear view of the watch shown in FIG. 1;  
FIG. 4 is a side view taken from the left in FIG. 1;  
FIG. 5 is a side view taken from the top in FIG. 1;  
FIG. 6 is a side view taken from the bottom in FIG. 1; and,  
FIG. 7 is a perspective view of the watch.

[56] **References Cited**  
**U.S. PATENT DOCUMENTS**  
D. 264,188 5/1982 Bvlgari ..... D10/39  
D. 311,694 10/1990 Woormer ..... D10/39

**1 Claim, 1 Drawing Sheet**

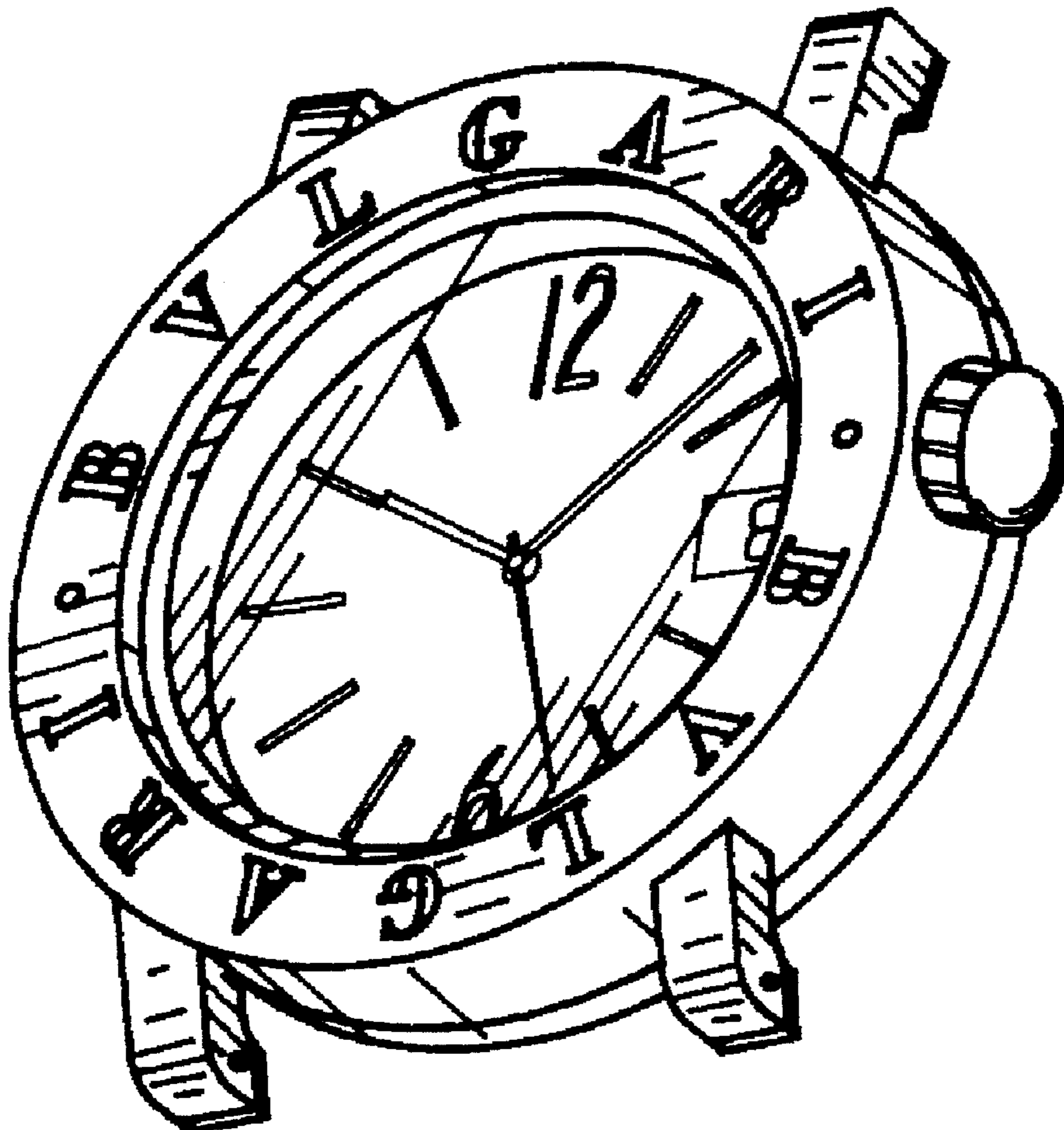

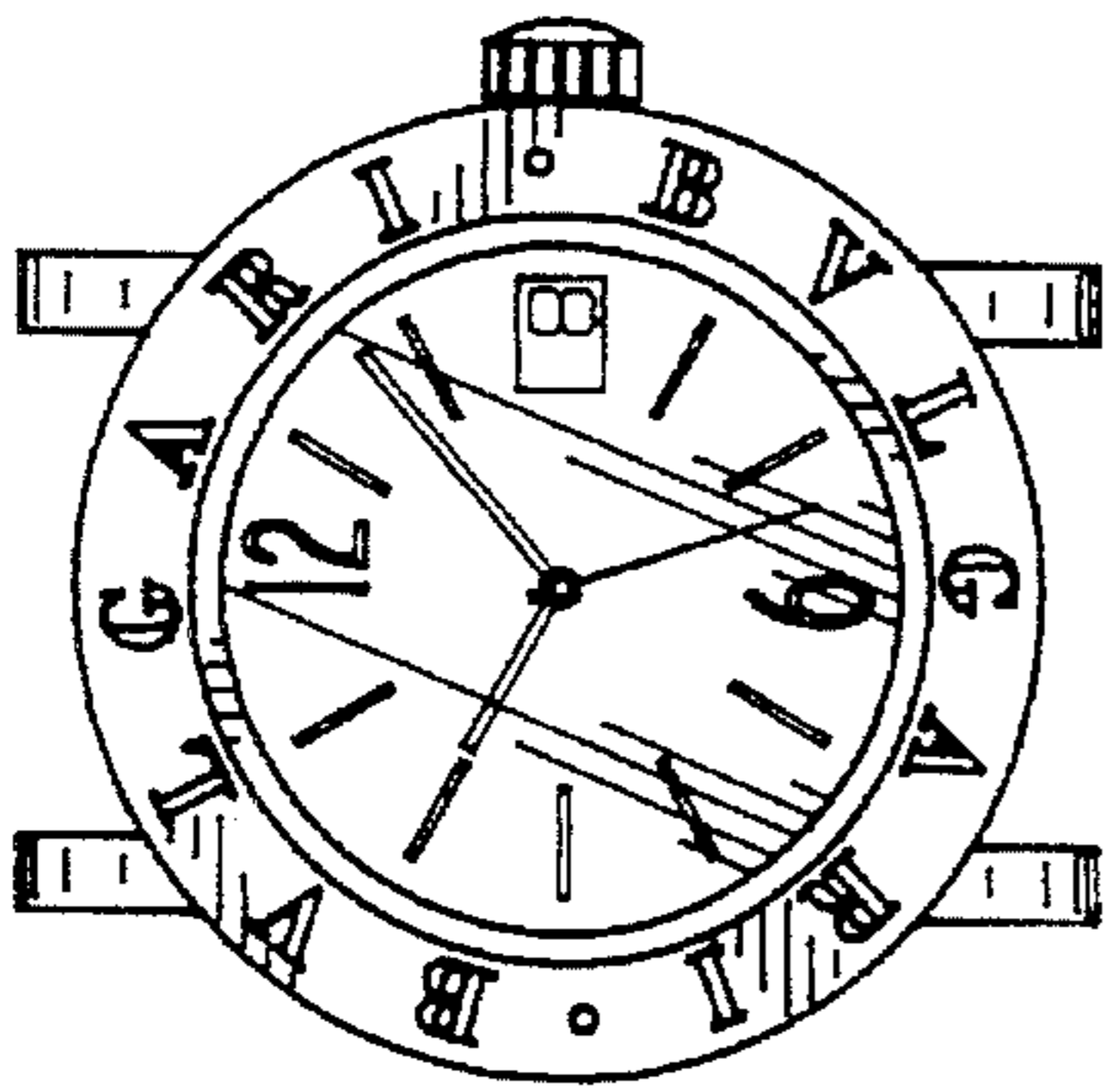

FIG. 1

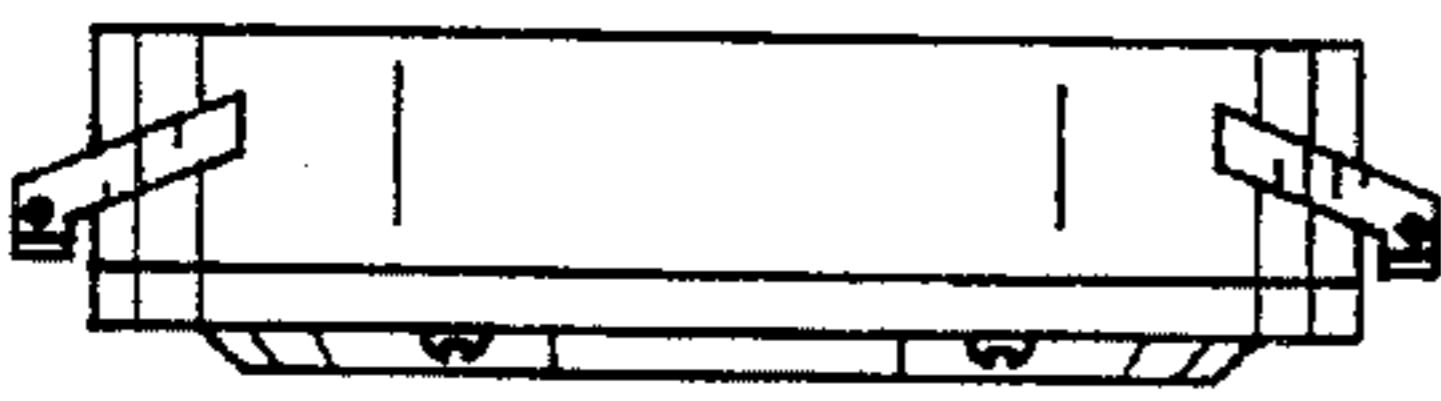

FIG. 2

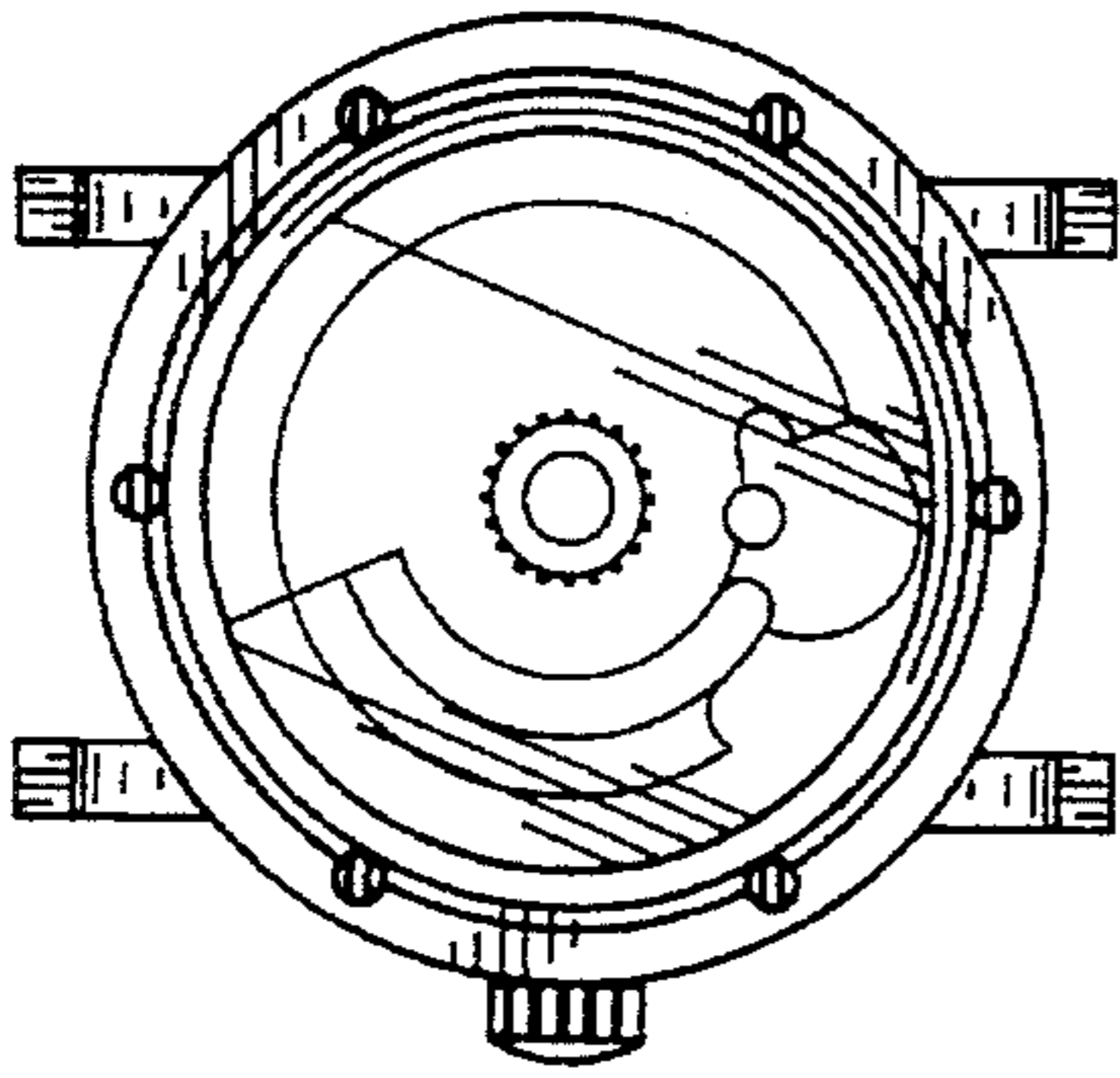

FIG. 3

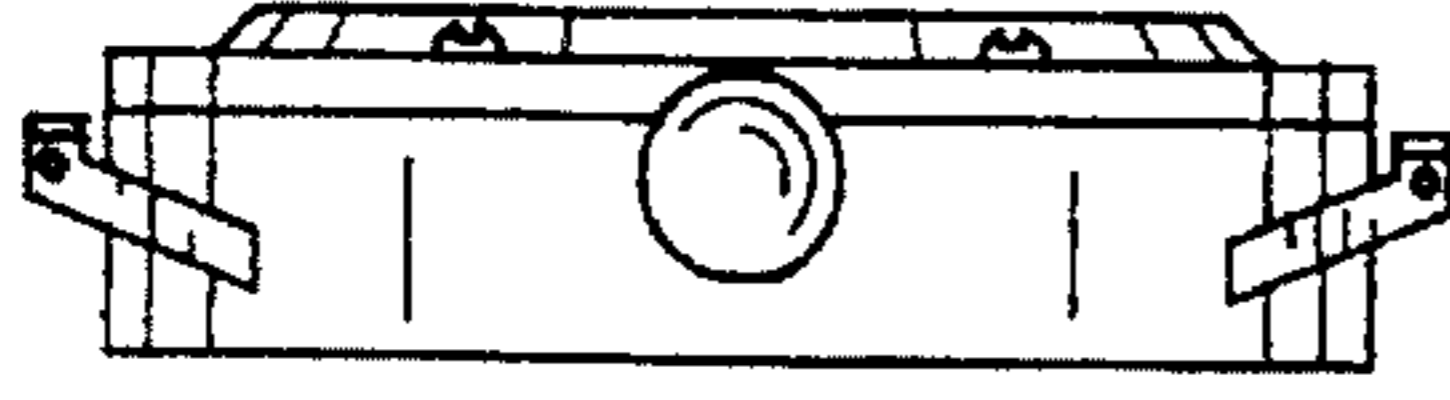

FIG. 4



FIG. 5

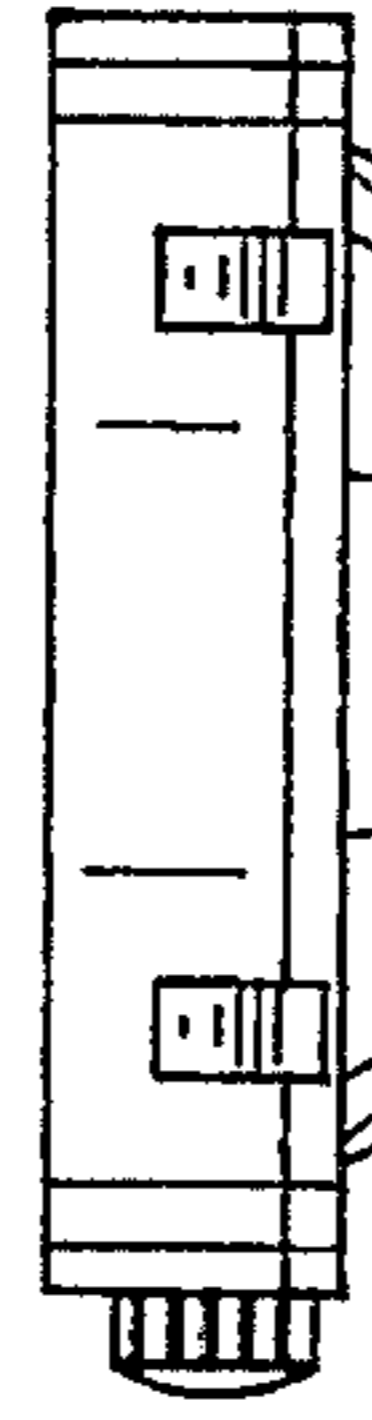

FIG. 6

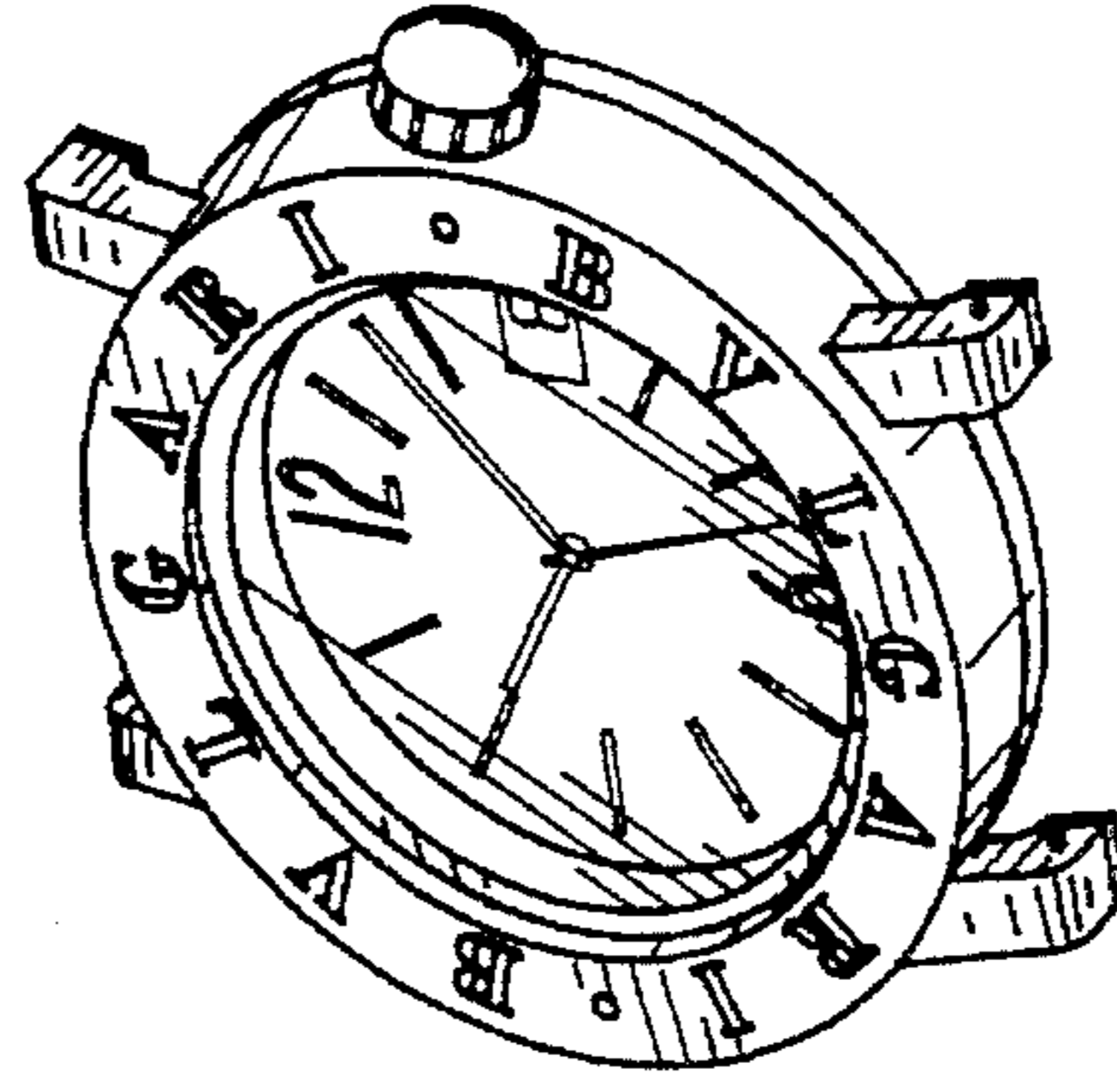

FIG. 7