



US00D362583S

United States Patent [19]

[11] Patent Number: **Des. 362,583**

Weber et al.

[45] Date of Patent: ****Sep. 26, 1995**

[54] **CARAFE WATER PURIFIER**
[75] Inventors: **Jeffrey A. Weber; William E. Stumpf; Timothy J. Prescott**, all of Minneapolis, Minn.

D. 314,139 1/1991 Ambaz D7/312 X
D. 345,670 4/1974 Piret D7/317 X
2,013,243 9/1935 Landon 222/465.1

[73] Assignee: **Recovery Engineering, Inc.**, Minneapolis, Minn.

OTHER PUBLICATIONS

Pitcher Goldschmiede Zeitung p. 32 Jul. 1972.
Jug Kettle, Design 408 Dec. 1982, p. 27.
Coffee Maker Model TC901, HFD Aug. 3, 1987, p. 71.

[**] Term: **14 Years**

Primary Examiner—Alan P. Douglas
Assistant Examiner—M. N. Pandozzi
Attorney, Agent, or Firm—Merchant, Gould, Smith, Edell, Welter & Schmidt

[21] Appl. No.: **19,438**

[22] Filed: **Mar. 2, 1994**

[52] U.S. Cl. **D7/321; D7/312; D23/209**

[57] CLAIM

[58] Field of Search D7/321, 397, 400, D7/300, 312, 316, 317, 318, 319, 608; D23/209; 222/465.1, 475.1; 366/314, 205

The ornamental design for a carafe water purifier, as shown.

DESCRIPTION

[56] References Cited

U.S. PATENT DOCUMENTS

D. 70,228 5/1926 Johnson D7/319
D. 70,229 5/1926 Johnson D7/321
D. 210,237 2/1968 Mestrovic D7/319
D. 213,796 4/1969 Marue D7/317
D. 258,563 3/1981 Romagnoli D7/321 X
D. 293,653 1/1988 Peters D7/319 X
D. 307,857 5/1990 Grome et al. D7/317

FIG. 1 is a perspective view of a carafe water purifier showing our new design;
FIG. 2 is a front elevational view thereof;
FIG. 3 is a rear elevational view thereof;
FIG. 4 is a left side elevational view thereof;
FIG. 5 is a right side elevational view thereof;
FIG. 6 is a top plan view thereof; and,
FIG. 7 is a bottom plan view thereof.

1 Claim, 4 Drawing Sheets

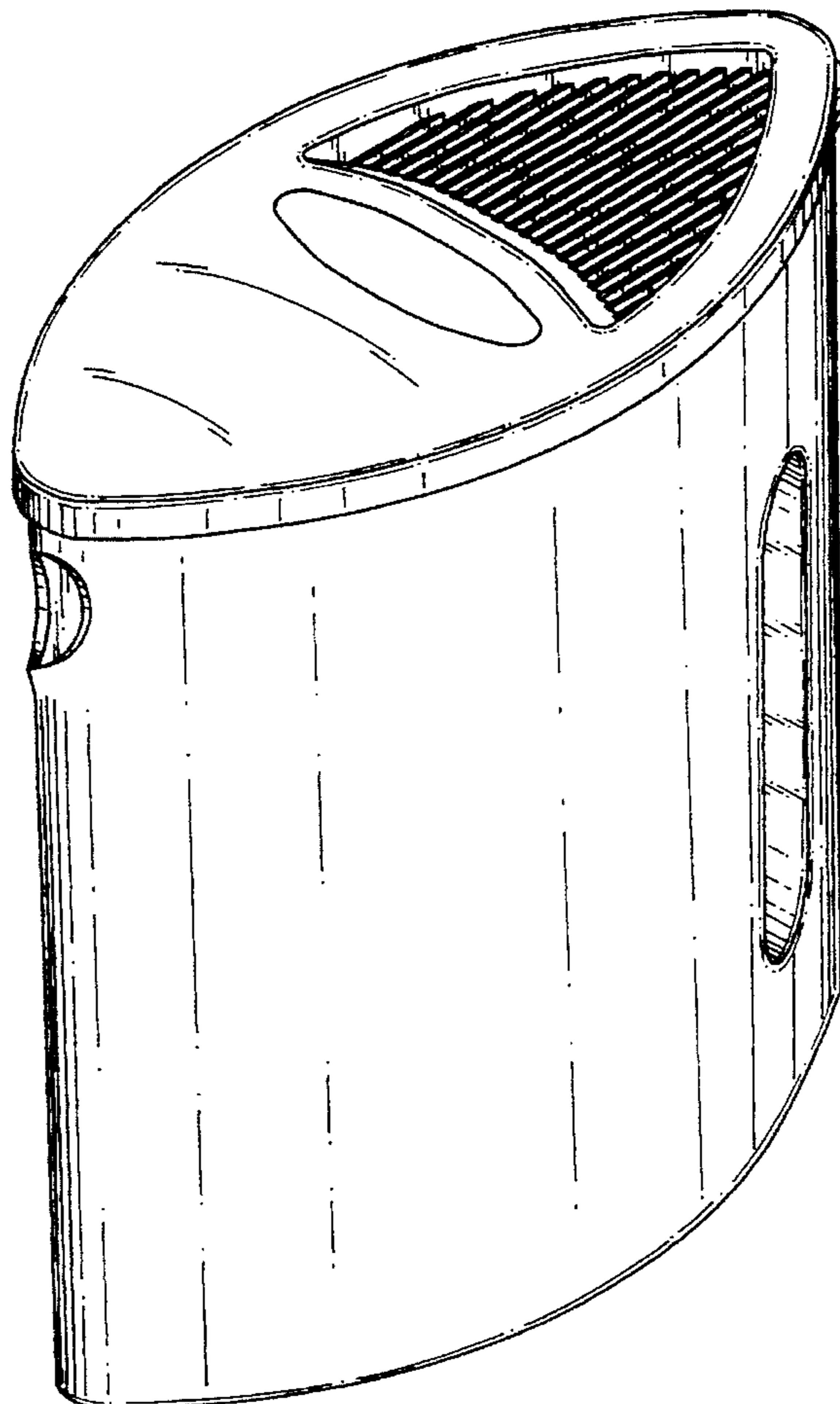

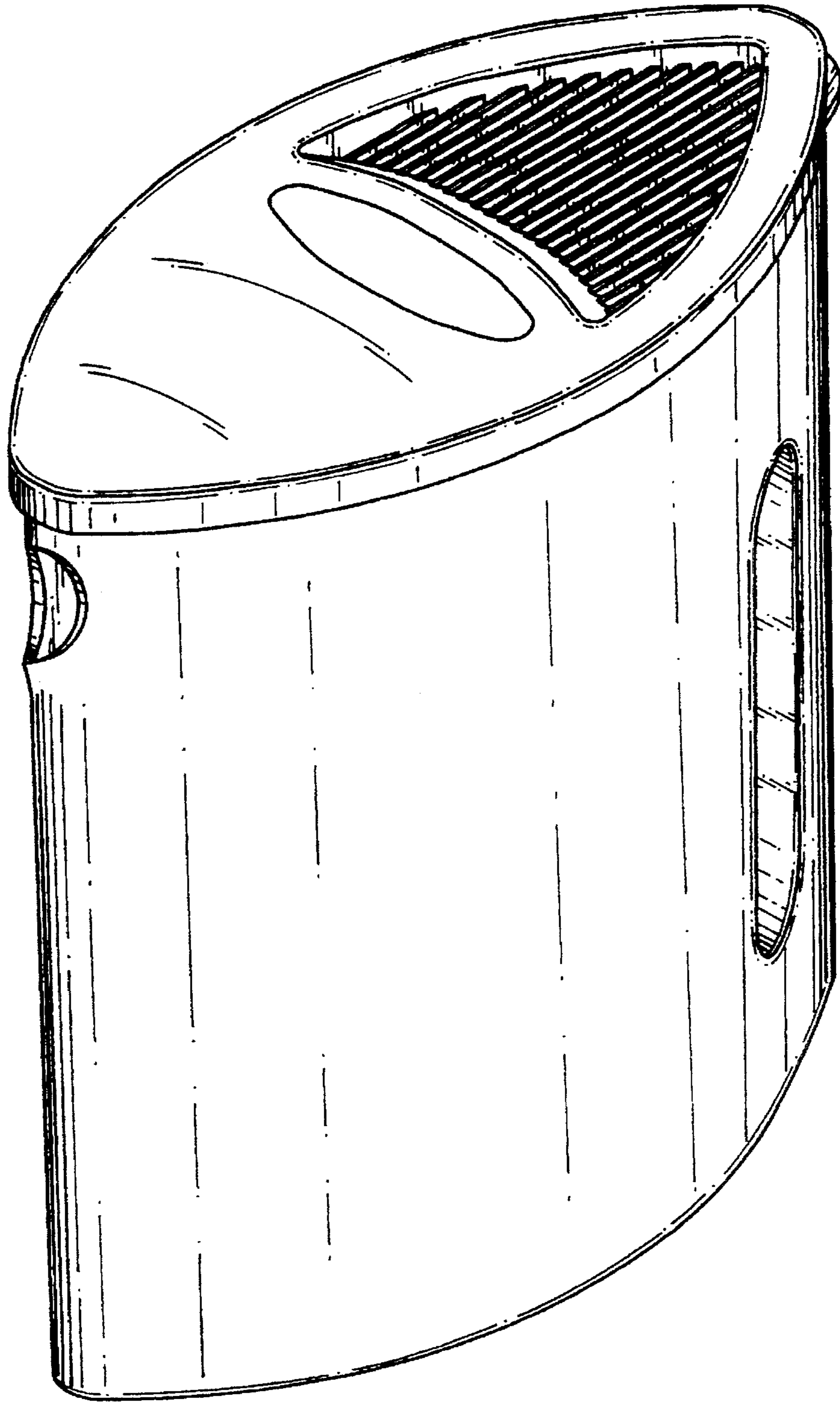

FIG. 1

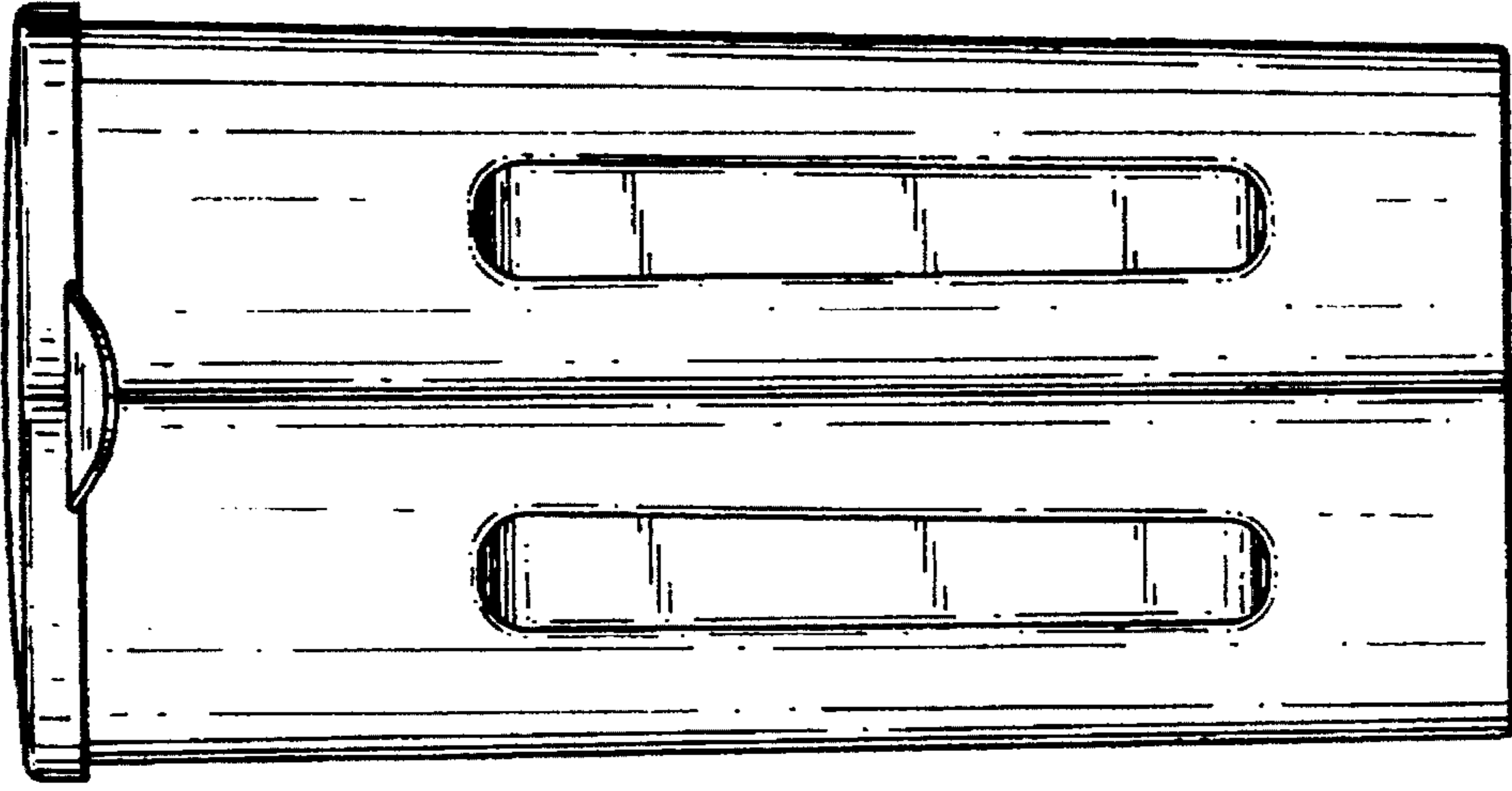

FIG. 3

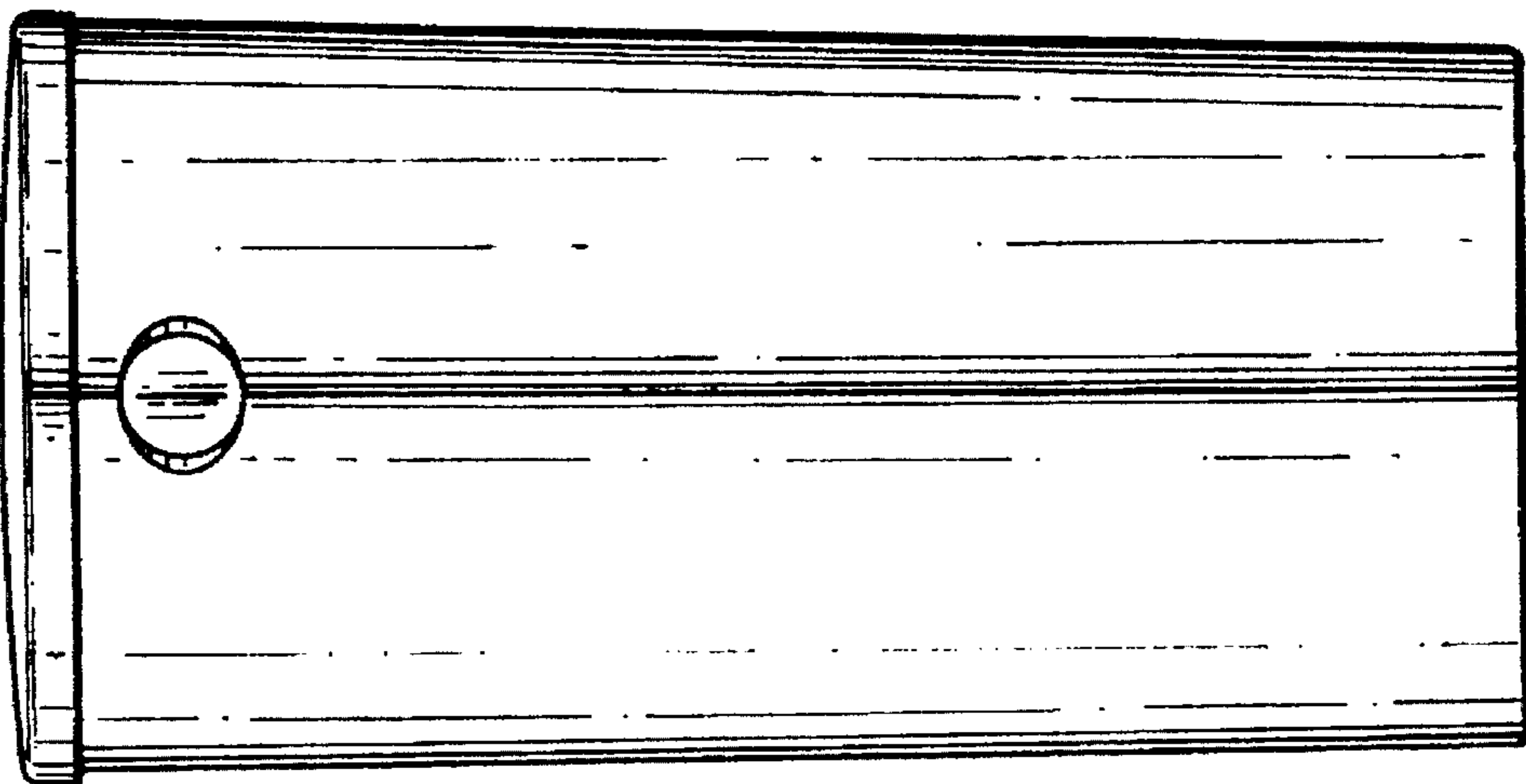

FIG. 2

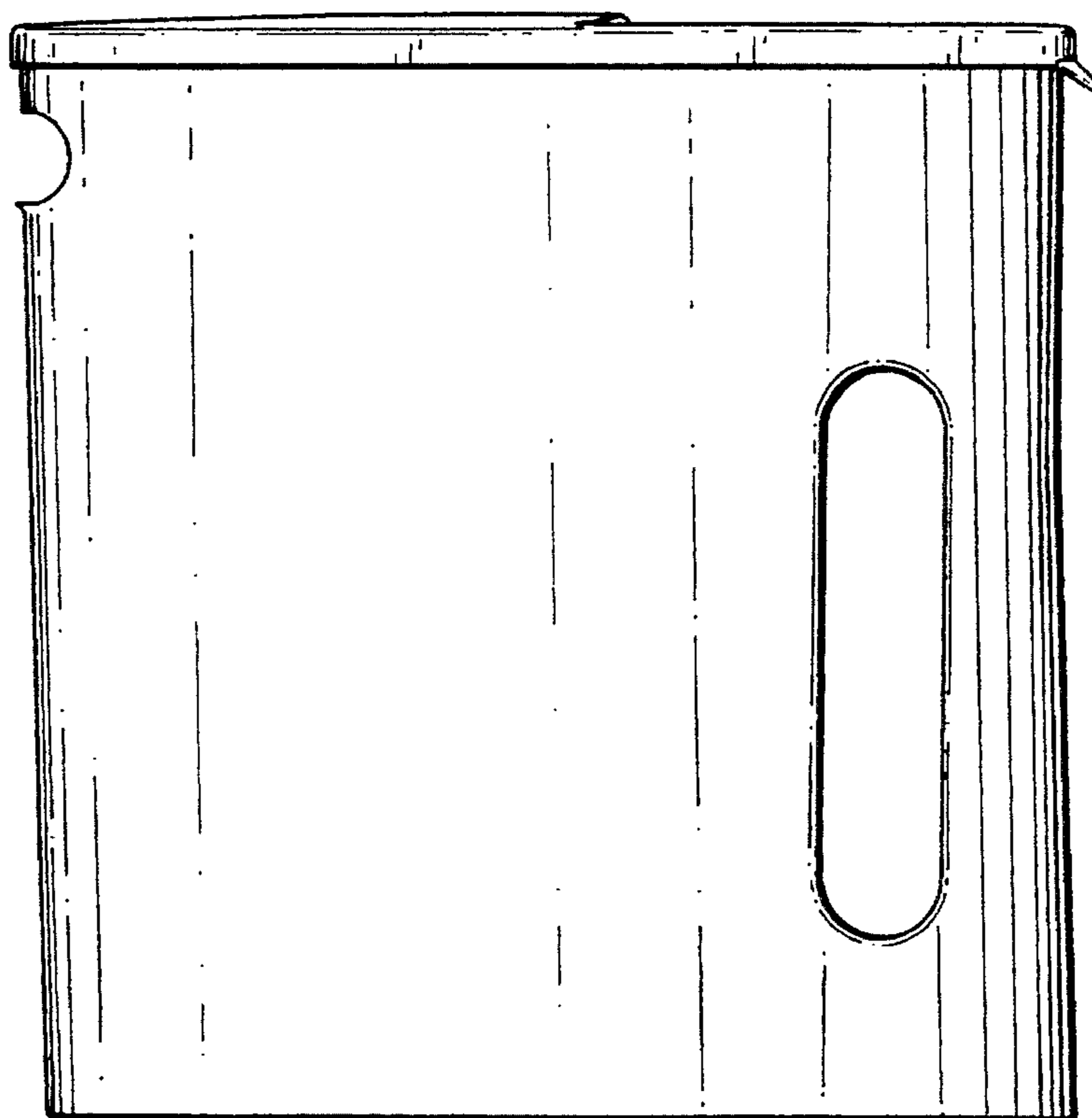

FIG. 4

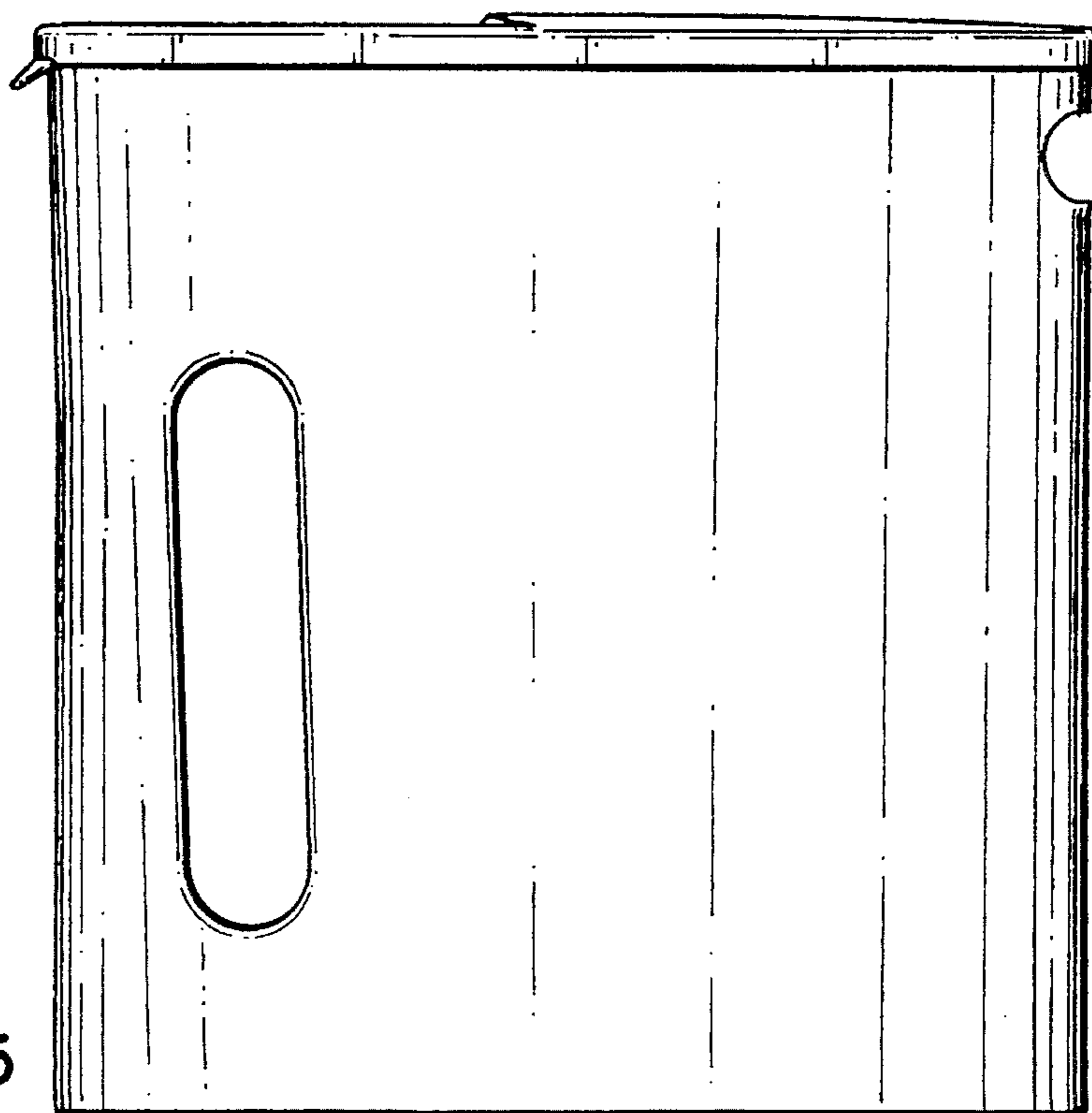

FIG. 5

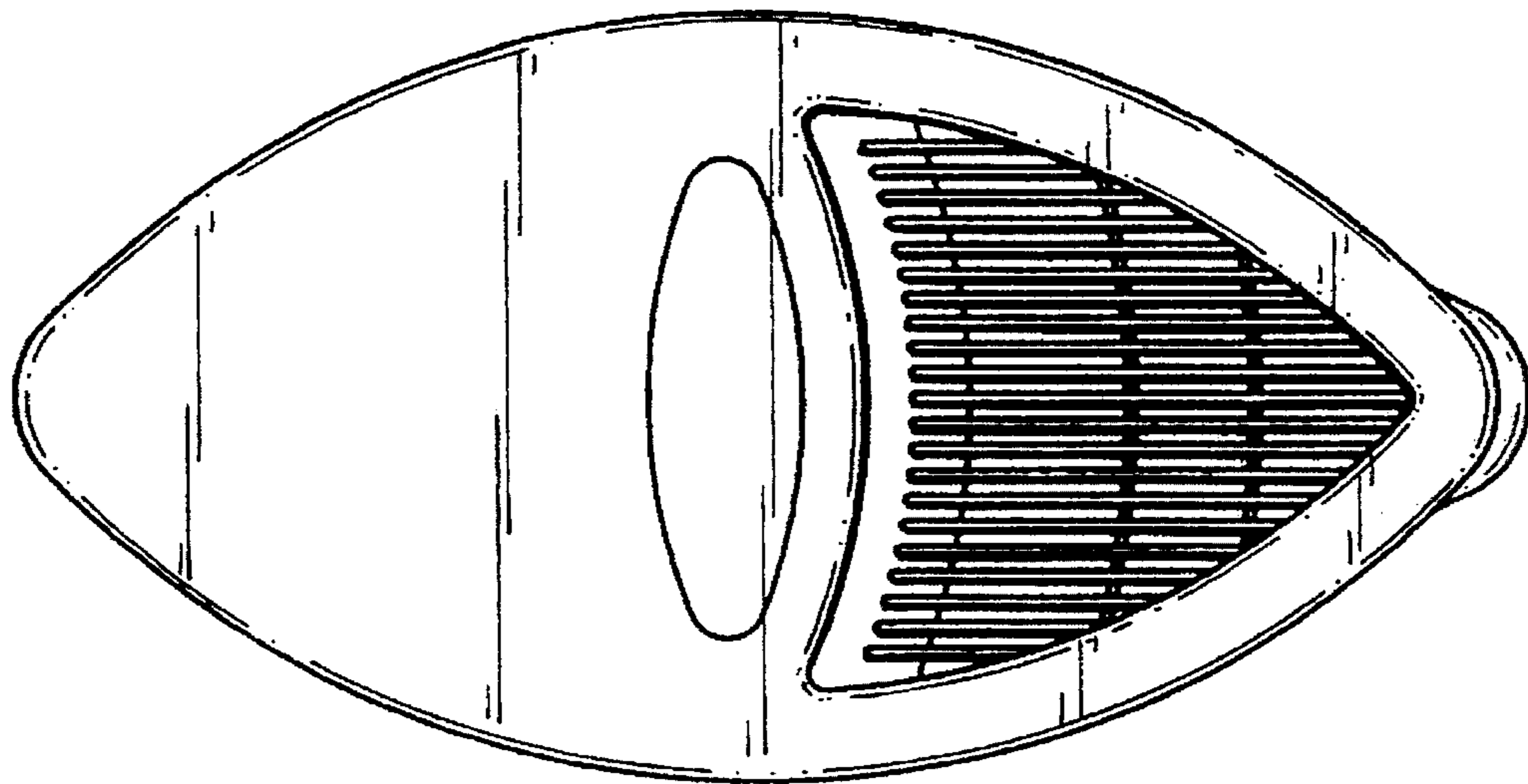

FIG. 6

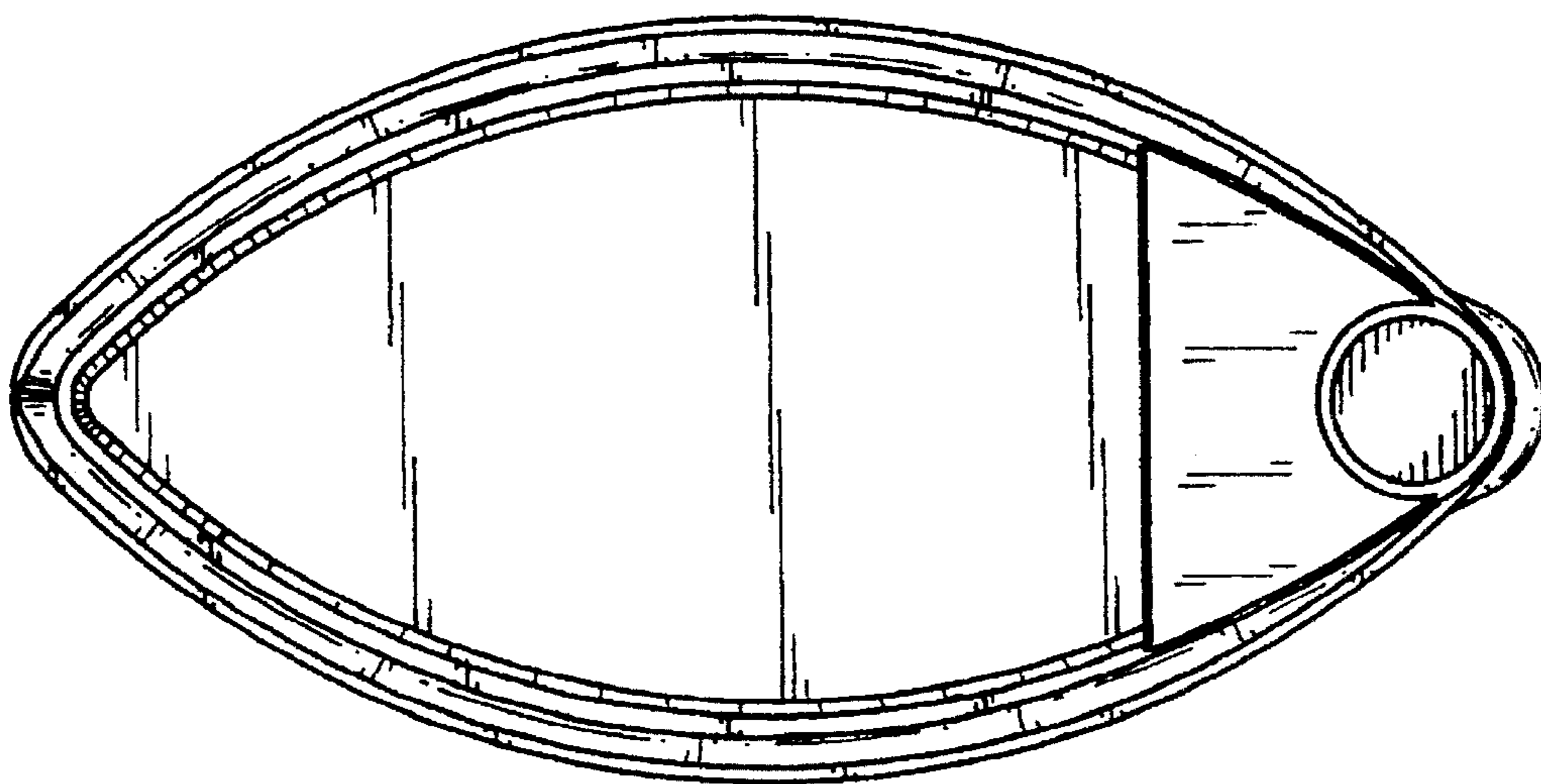

FIG. 7