



US00D362490S

# United States Patent [19]

[11] Patent Number: Des. 362,490

McAllister et al.

[45] Date of Patent: \*\* Sep. 19, 1995

[54] **COMBINED BARRIER FREE TUB AND SHOWER**

[76] Inventors: **George P. McAllister**, 168 Spencer Creek Rd.; **William Stewart**, 1807 Blue Springs Ct., both of Franklin, Tenn. 37064

[\*\*] Term: **14 Years**

[21] Appl. No.: **26,243**

[22] Filed: **Jul. 22, 1994**

[52] U.S. Cl. .... **D23/283**

[58] Field of Search ..... **D23/304, 283; 4/559, 4/568, 580, 581, 583, 654, 657, 539, 546, 575.1, 584, 589, 590, 591, 593, 592, 594**

[56] **References Cited**

**U.S. PATENT DOCUMENTS**

4,890,341	1/1990	Forbes	.....	4/559 X
5,163,187	11/1992	Dannenberg et al.	.....	4/557 X
5,351,345	10/1994	Sills et al.	.....	4/557 X

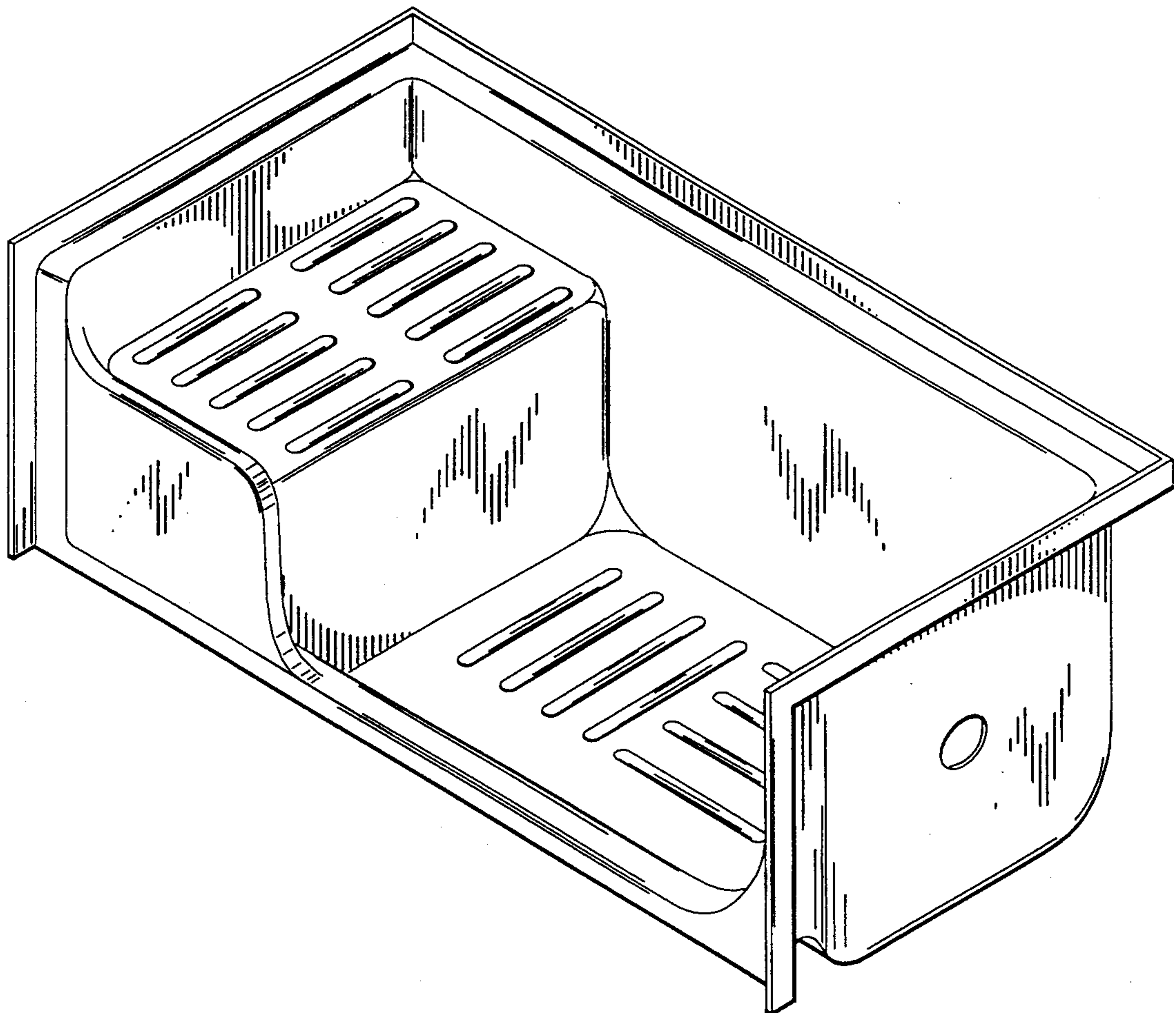
*Primary Examiner*—Stella Reid  
*Assistant Examiner*—E. Watterson  
*Attorney, Agent, or Firm*—B. Craig Killough

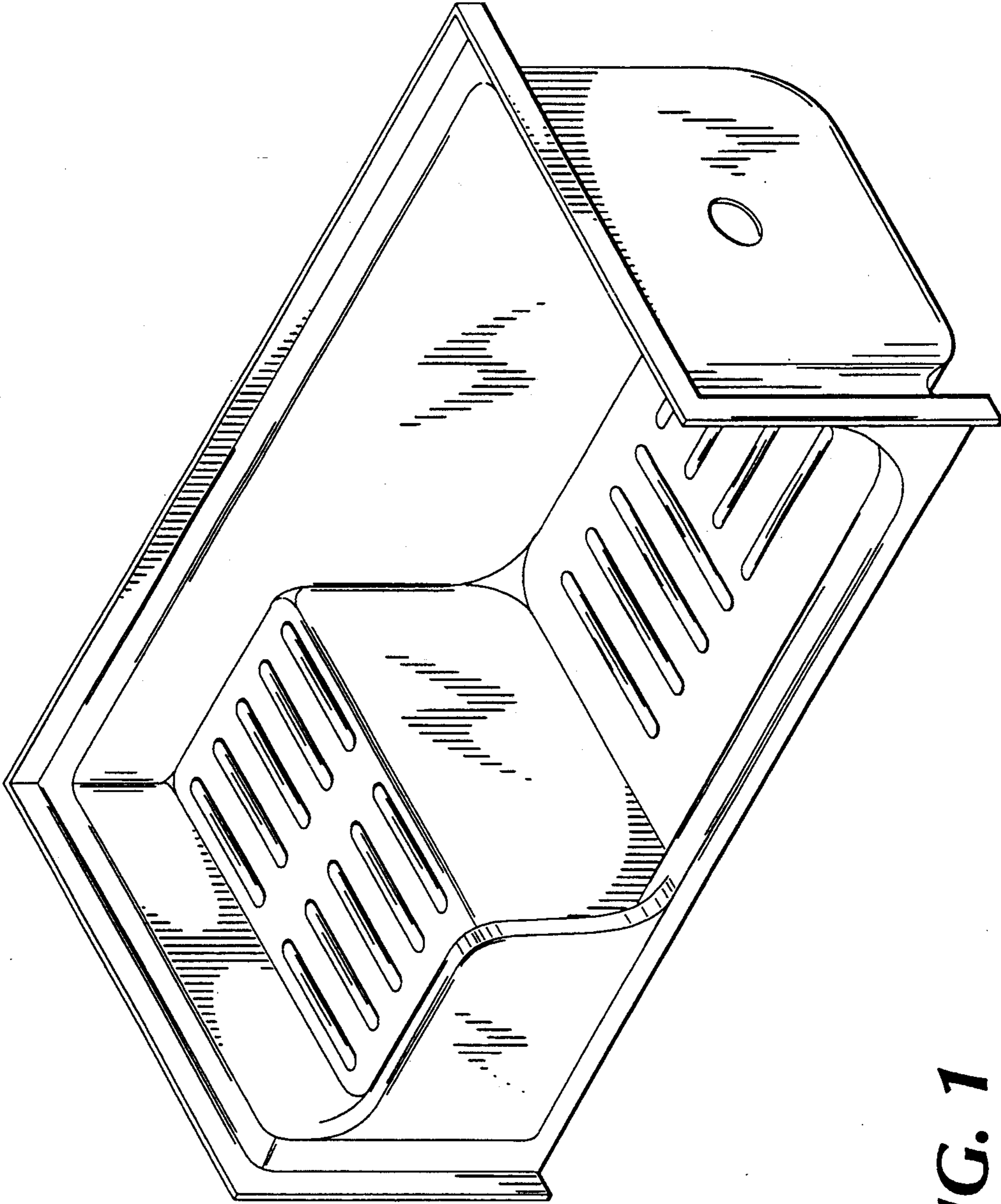
[57] **CLAIM**

The ornamental design for the combined barrier-free tub and shower, as shown.

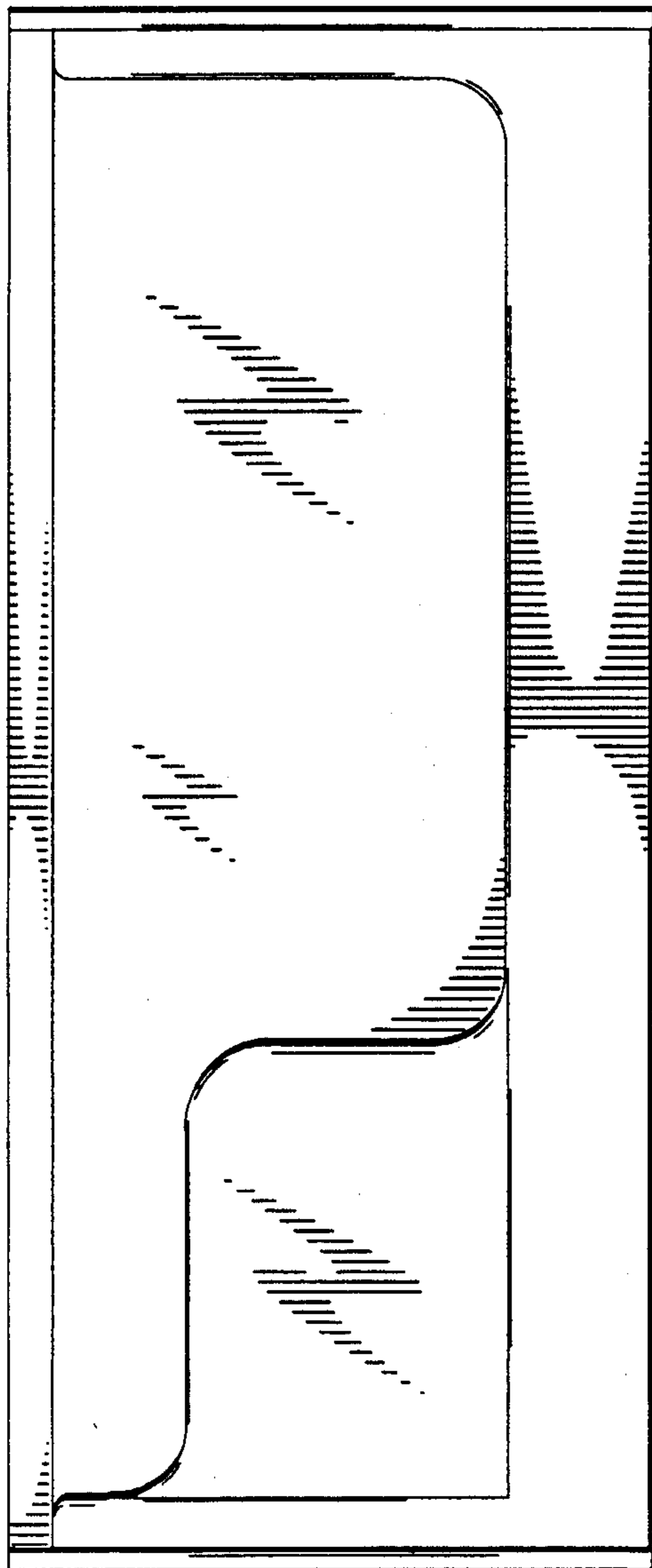
**DESCRIPTION**

FIG. 1 is a perspective view of the combined barrier-free tub and shower;  
FIG. 2 is a front elevation of the combined barrier-free tub and shower;  
FIG. 3 is a rear elevation of the combined barrier-free tub and shower;  
FIG. 4 is a left side elevation of the combined barrier-free tub and shower;  
FIG. 5 is a right side elevation of the combined barrier-free tub and shower;  
FIG. 6 is a top, plan view of the combined barrier-free tub and shower; and,  
FIG. 7 is a bottom plan view of the combined barrier-free tub and shower.

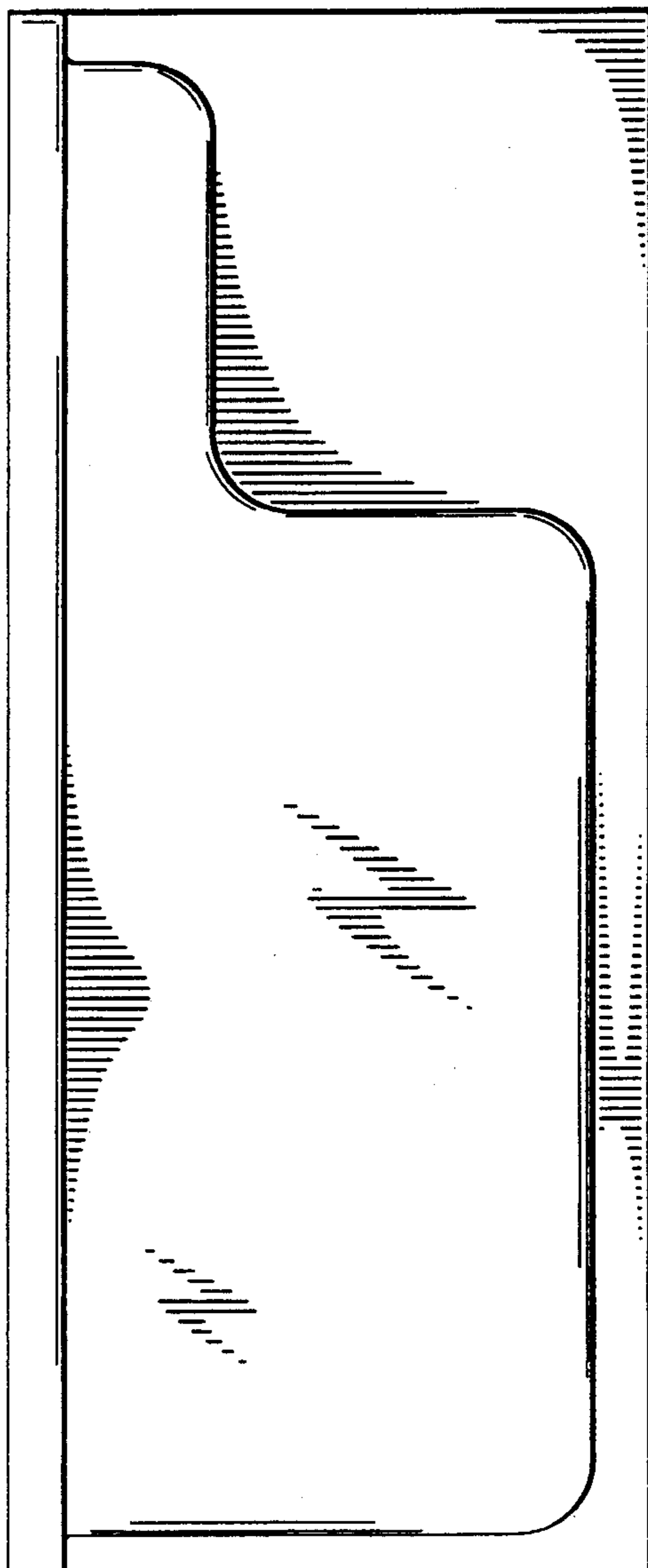




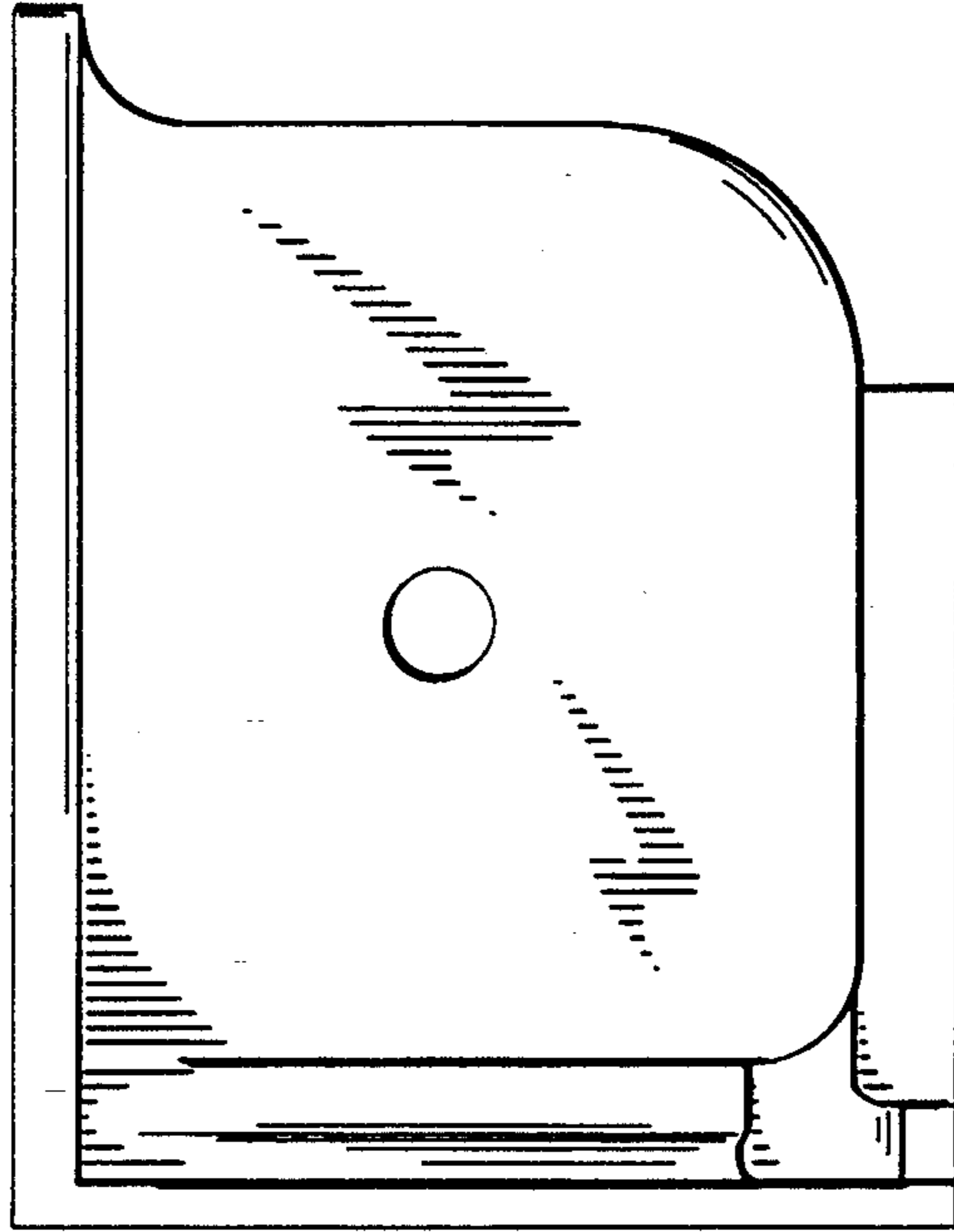
**FIG. 1**



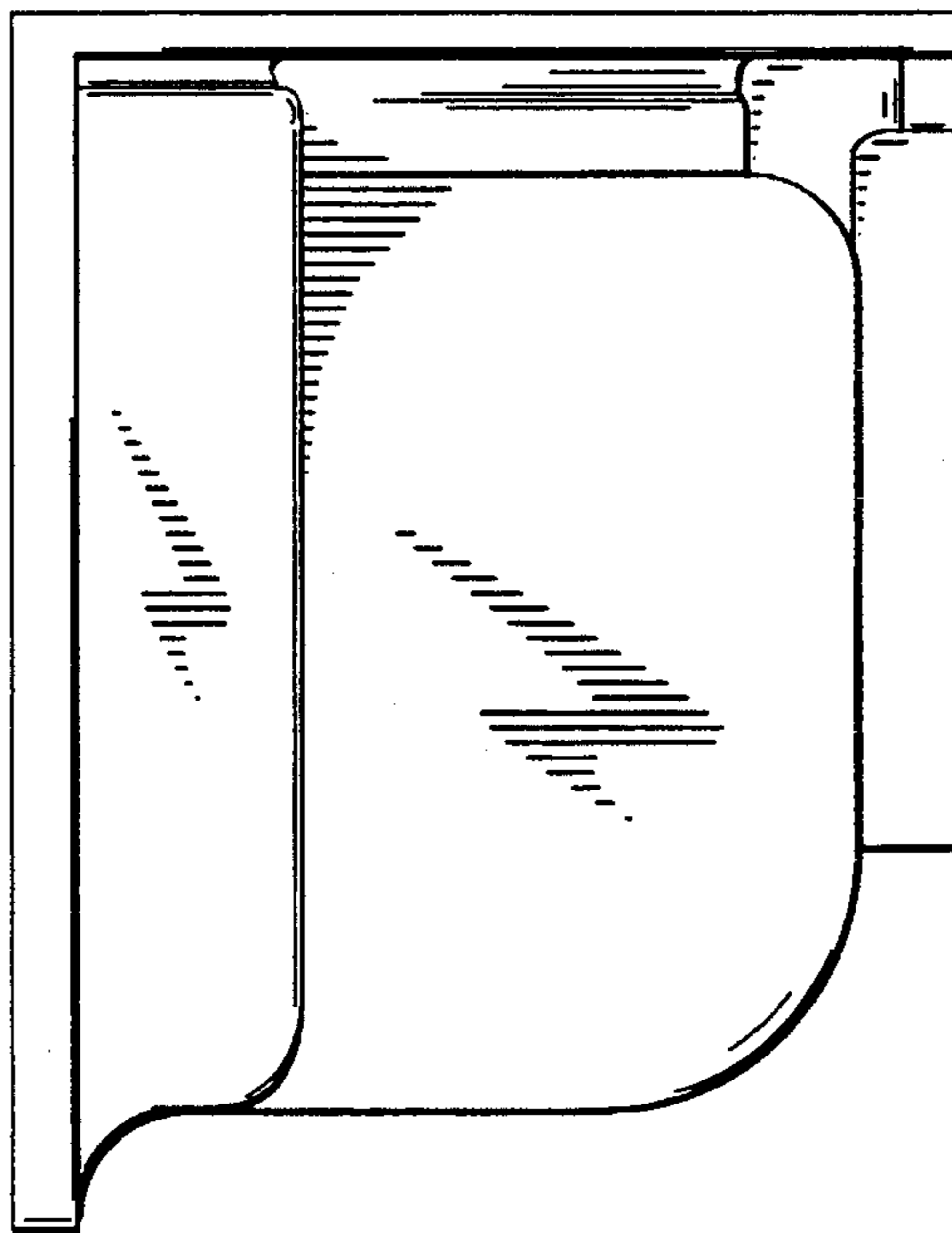
**FIG. 2**



**FIG. 3**

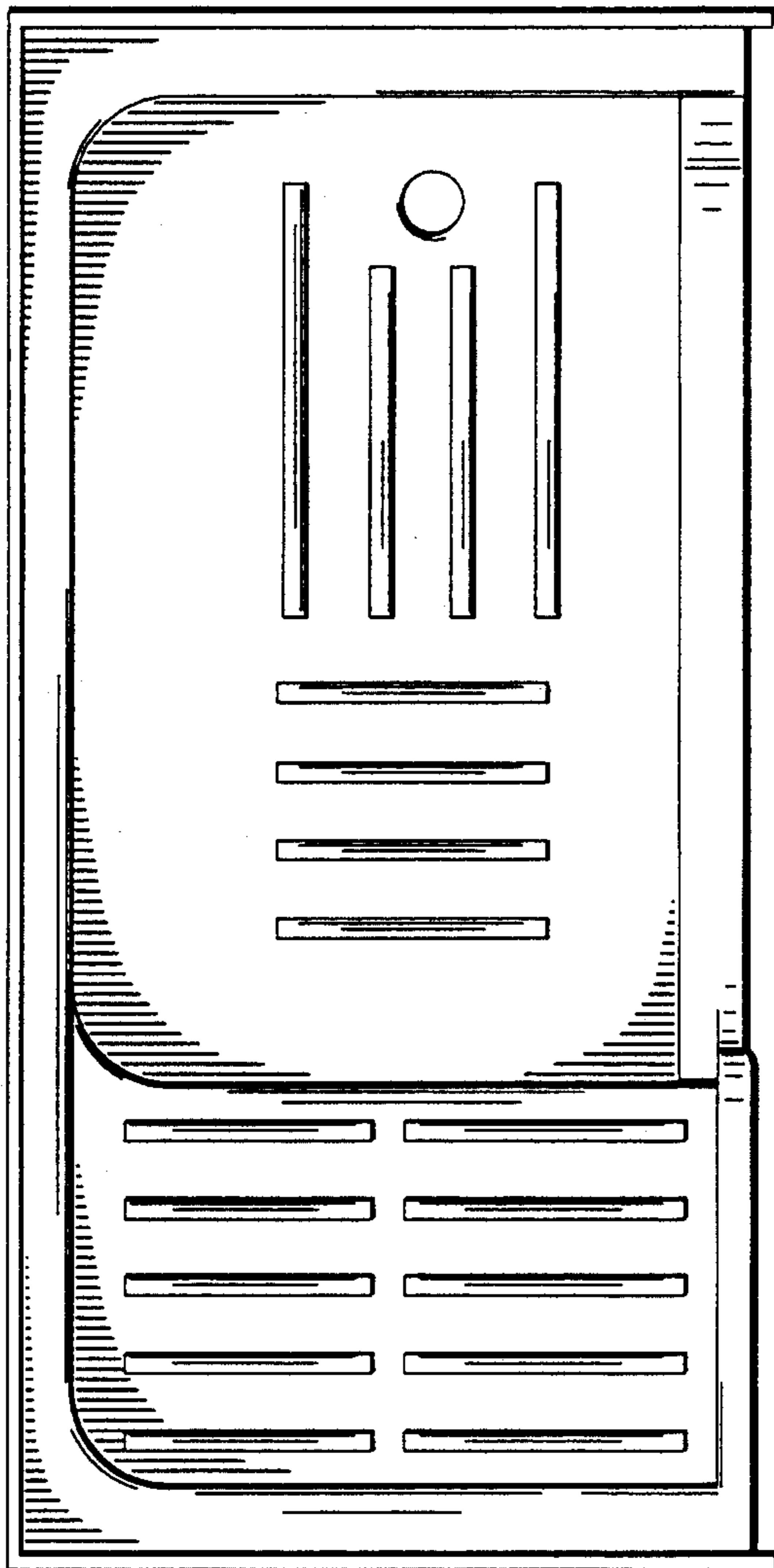


**FIG. 5**

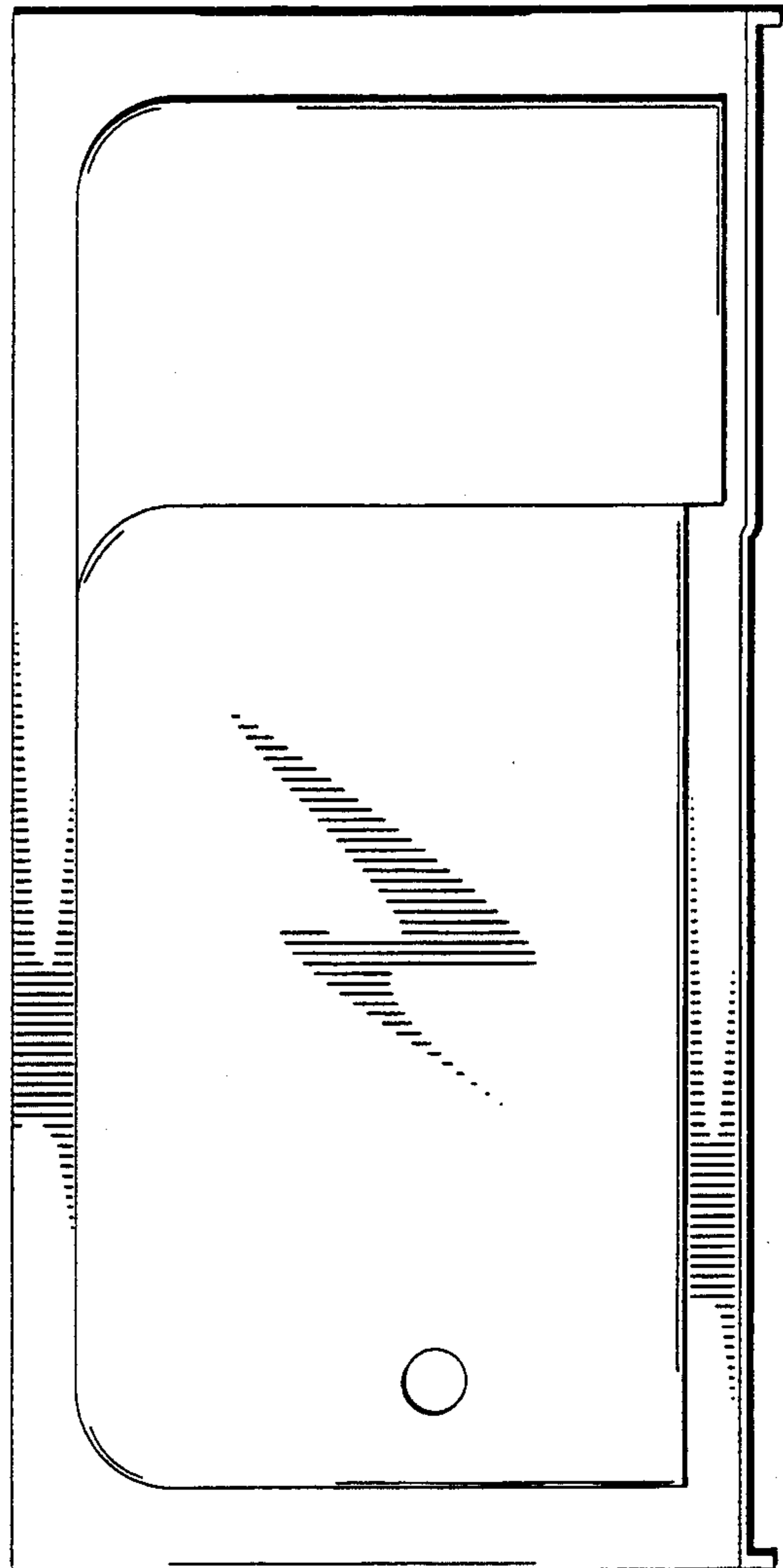


**FIG. 4**





**FIG. 6**



**FIG. 7**