



US00D362477S

United States Patent [19]

[11] Patent Number: **Des. 362,477**

Bluestein

[45] Date of Patent: **** Sep. 19, 1995**

[54] **COMBINED EXERCISE STEP AND PUNCHING BAG STAND**

4,216,957	8/1980	Curatola .	
4,482,150	11/1984	Levine	482/90
4,557,478	12/1985	Levine .	
4,569,401	2/1986	Luck	482/57
5,050,866	9/1991	Fucci .	

[76] Inventor: **Keith Bluestein, 30 Hall Rd., Stoneham, Mass. 02180**

Primary Examiner—Theodore M. Shooman
Assistant Examiner—Philip Hyder

[**] Term: **14 Years**

[21] Appl. No.: **18,270**

[57] CLAIM

[22] Filed: **Feb. 2, 1994**

The ornamental design for the combined exercise step and punching bag stand, as shown and described.

[52] U.S. Cl. **D21/191**

[58] Field of Search **D21/191; 482/83, 85, 482/86, 87, 90, 51, 52, 57; D25/65**

DESCRIPTION

[56] References Cited

U.S. PATENT DOCUMENTS

D. 269,828	7/1983	Greene	D25/65
D. 330,057	10/1992	Saunders et al.	D21/191
D. 330,234	10/1992	Saunders et al.	D21/191
D. 330,235	10/1992	Traetta et al.	D21/191
825,860	7/1906	McKenzie	D21/197
2,625,356	1/1953	Kennedy et al.	482/90
3,510,131	5/1970	Gardner .	
3,650,530	3/1972	Gantz .	

FIG. 1 is a front elevational view of the combined exercise step and punching bag stand showing my new design;
 FIG. 2 is a rear elevational view thereof;
 FIG. 3 is a left side elevational view thereof;
 FIG. 4 is a right side elevational view thereof, the broken line portions being for illustrative purposes only and forming no part of the claimed design;
 FIG. 5 is a top plan view thereof;
 FIG. 6 is a bottom plan view thereof; and,
 FIG. 7 is an upper right perspective view thereof.

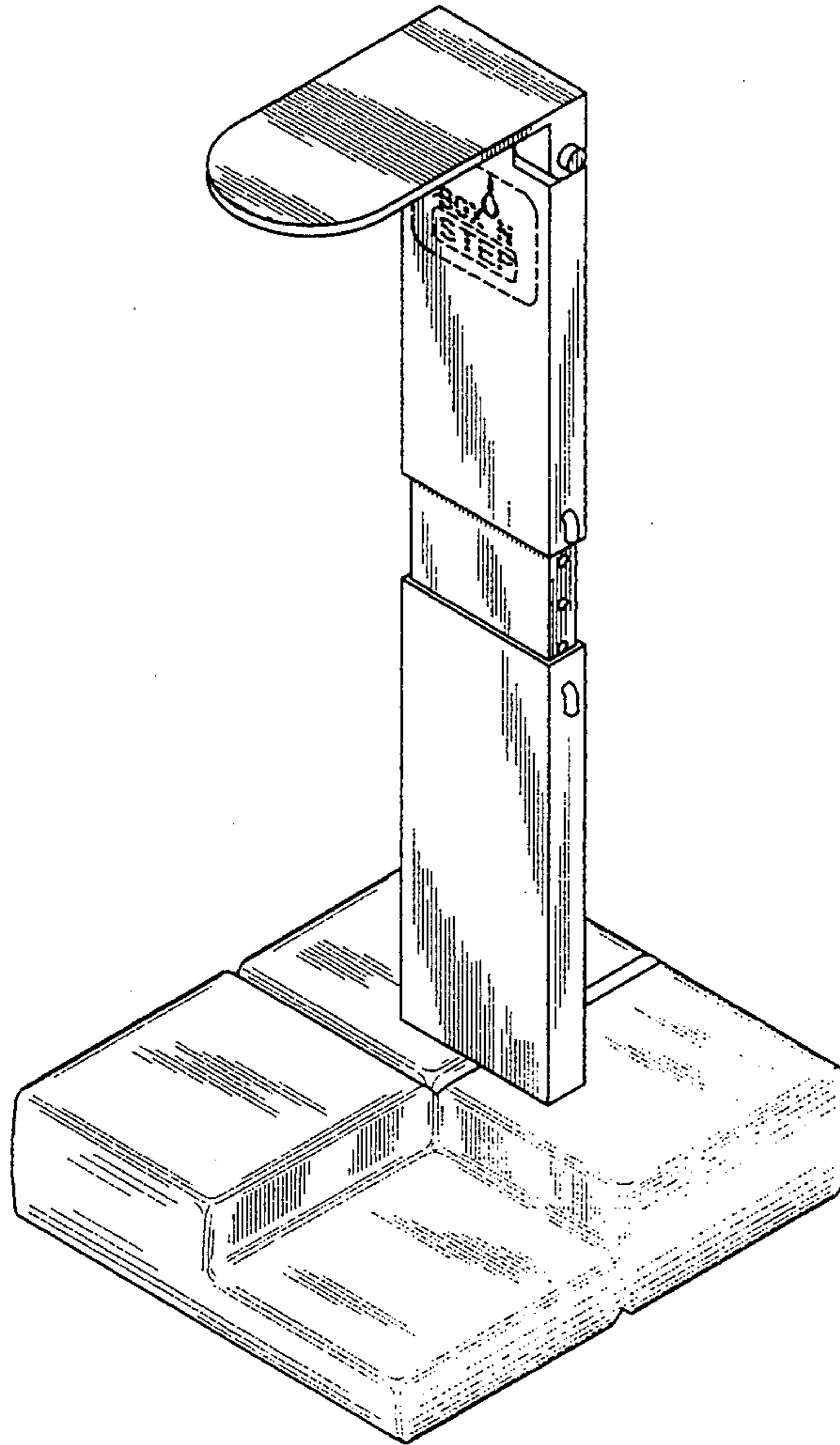

FIG. 1

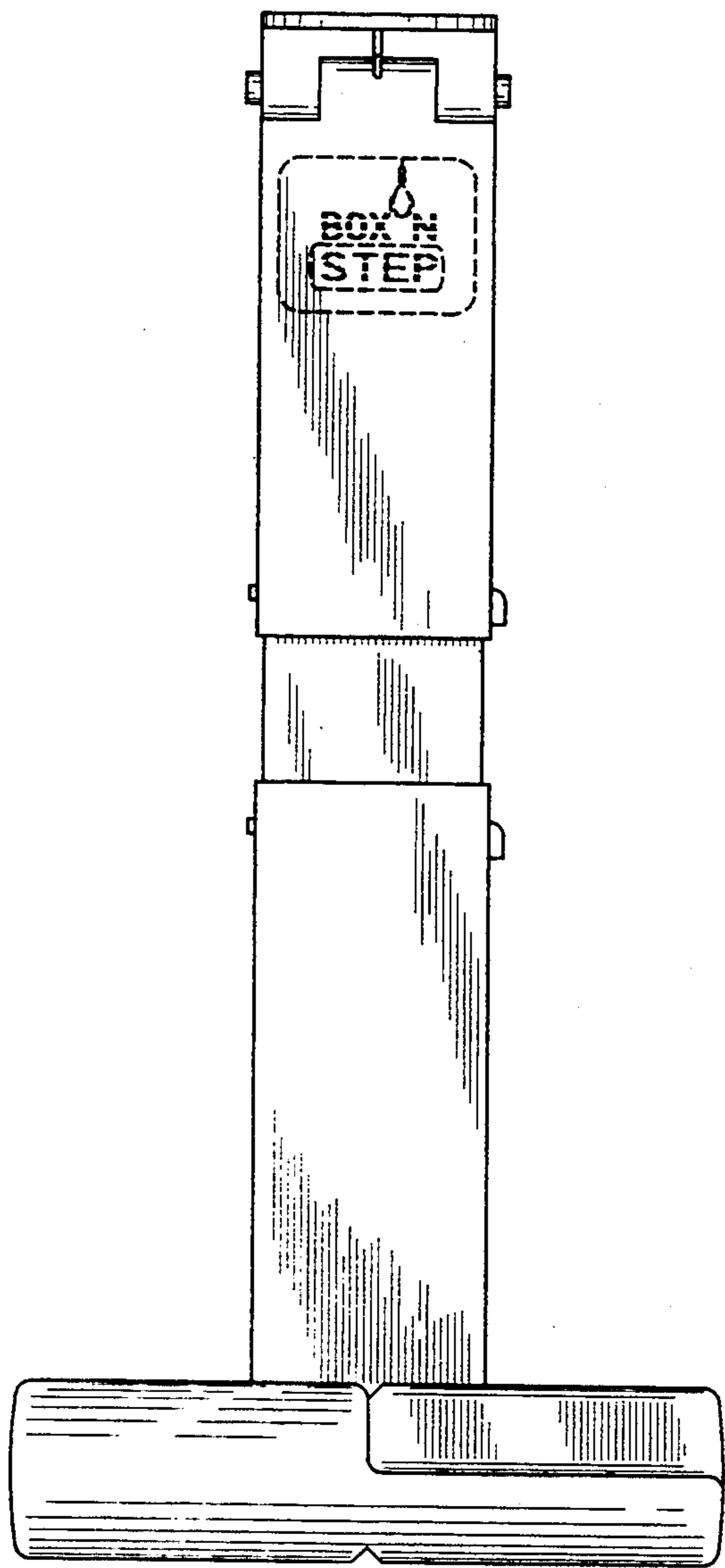

FIG. 2

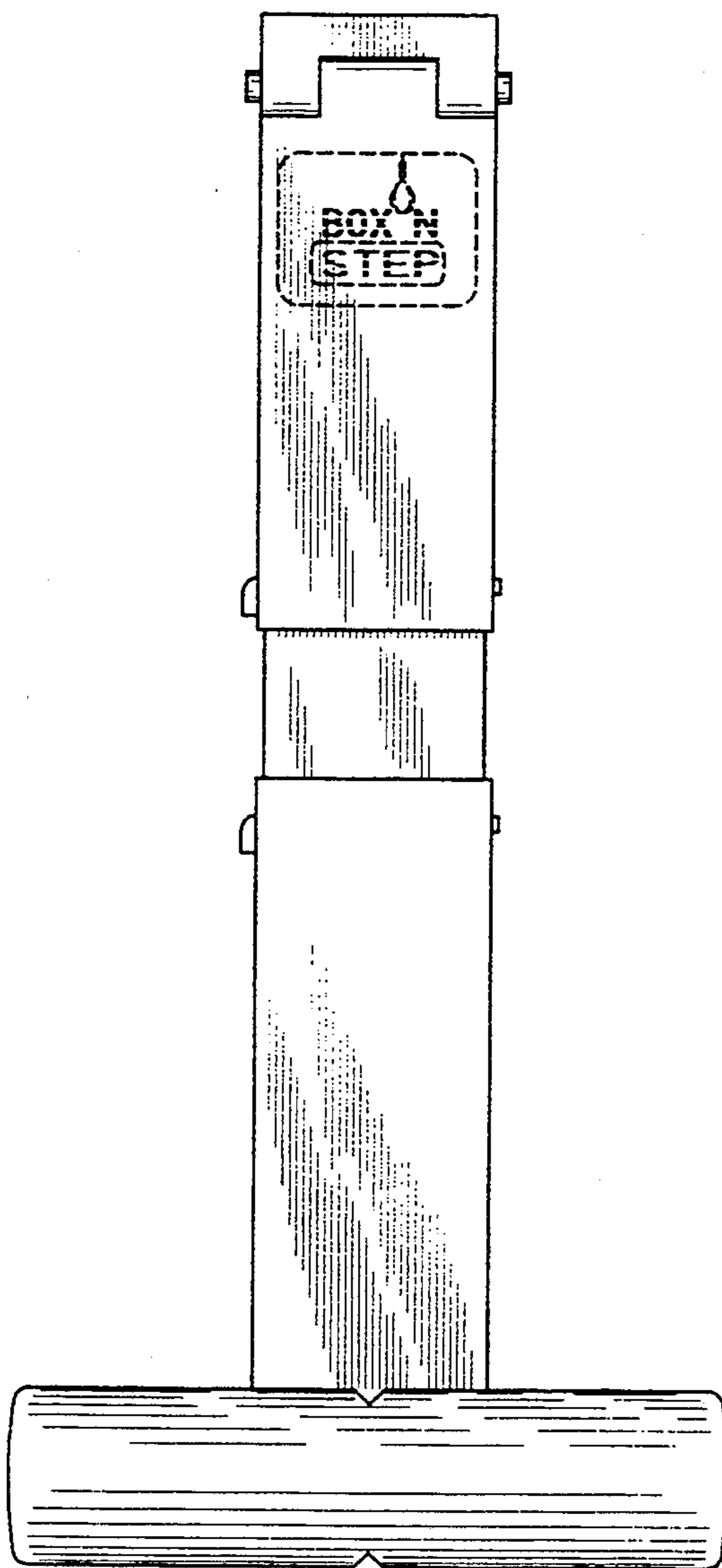

FIG. 3

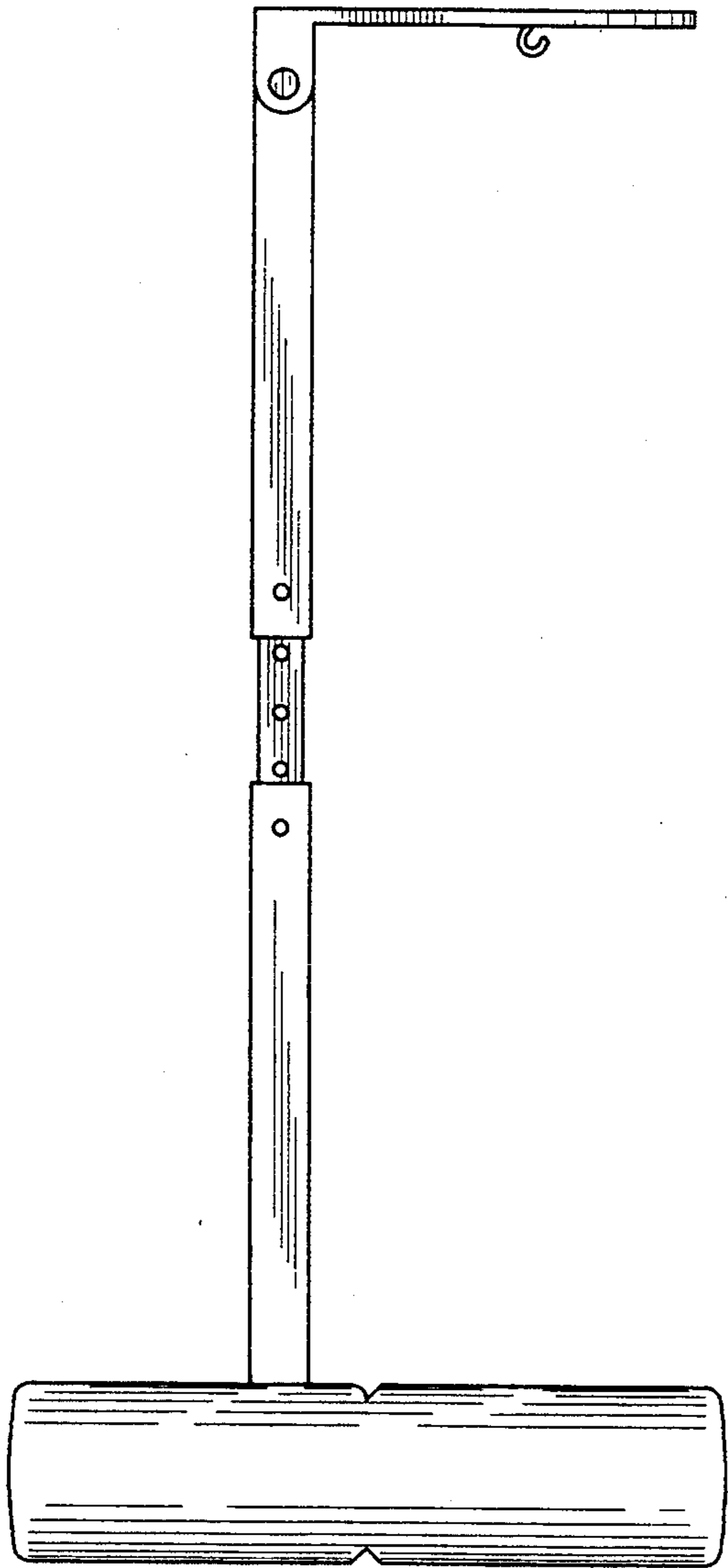

FIG. 4

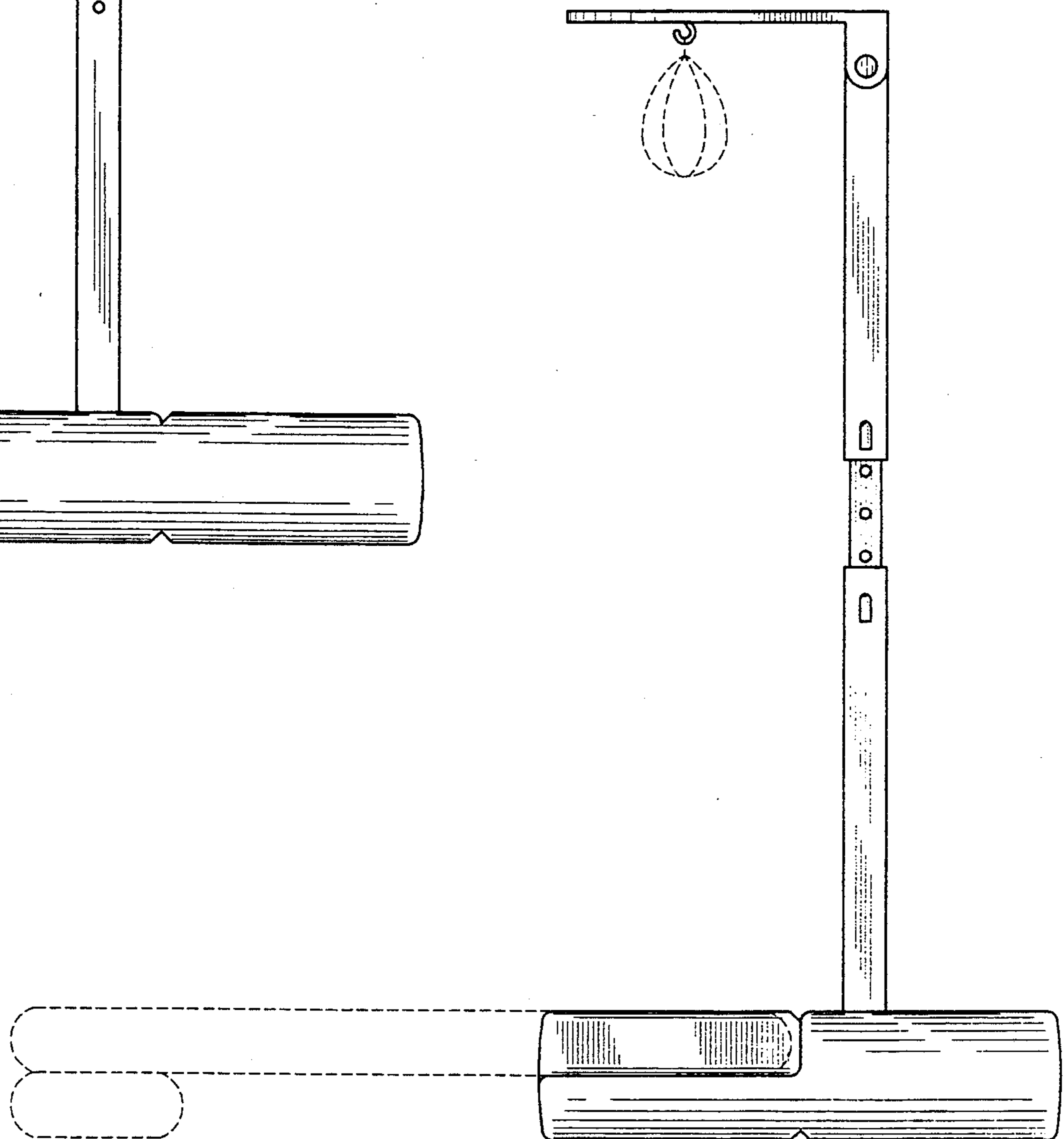

FIG. 5

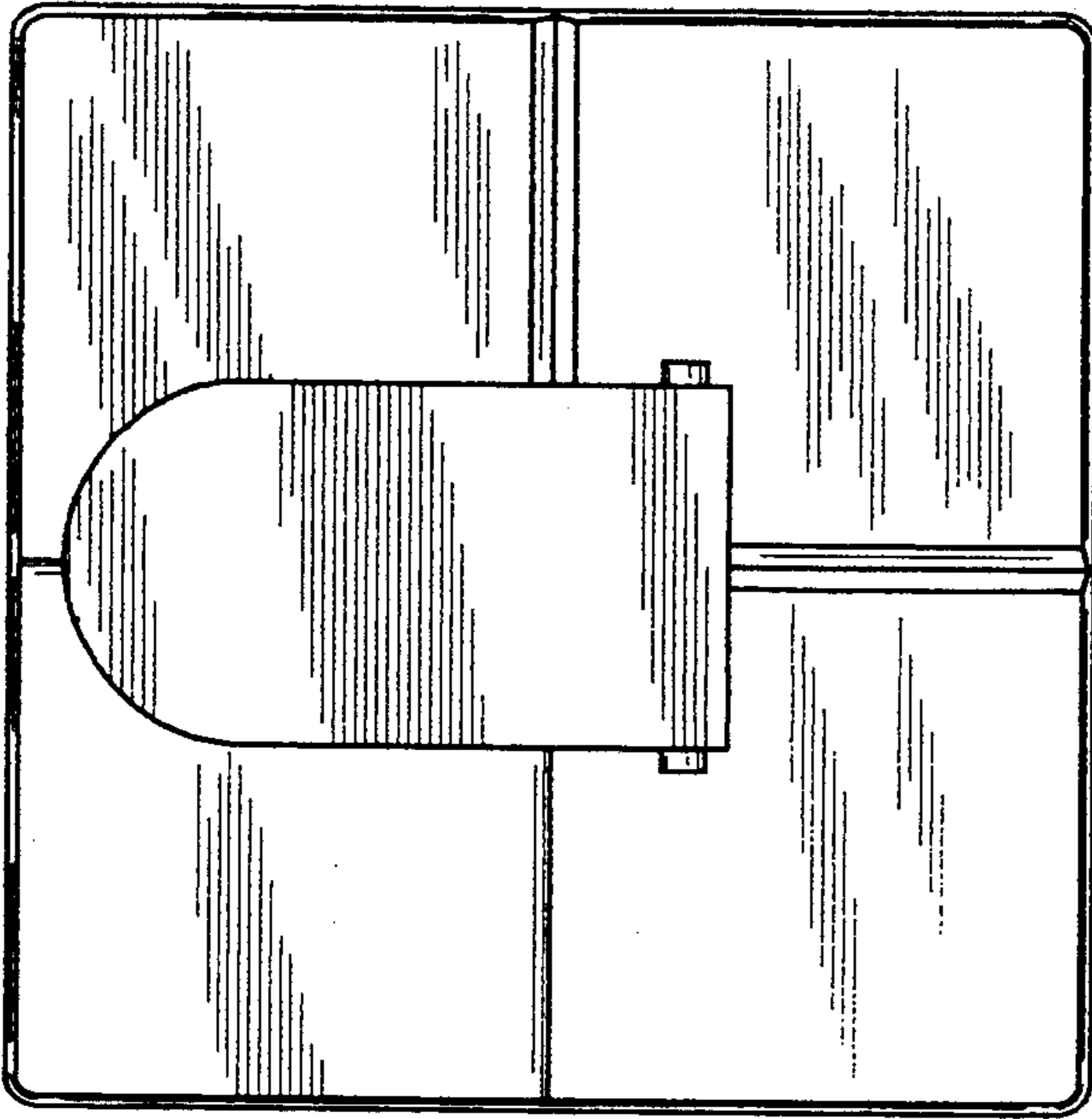

FIG. 6

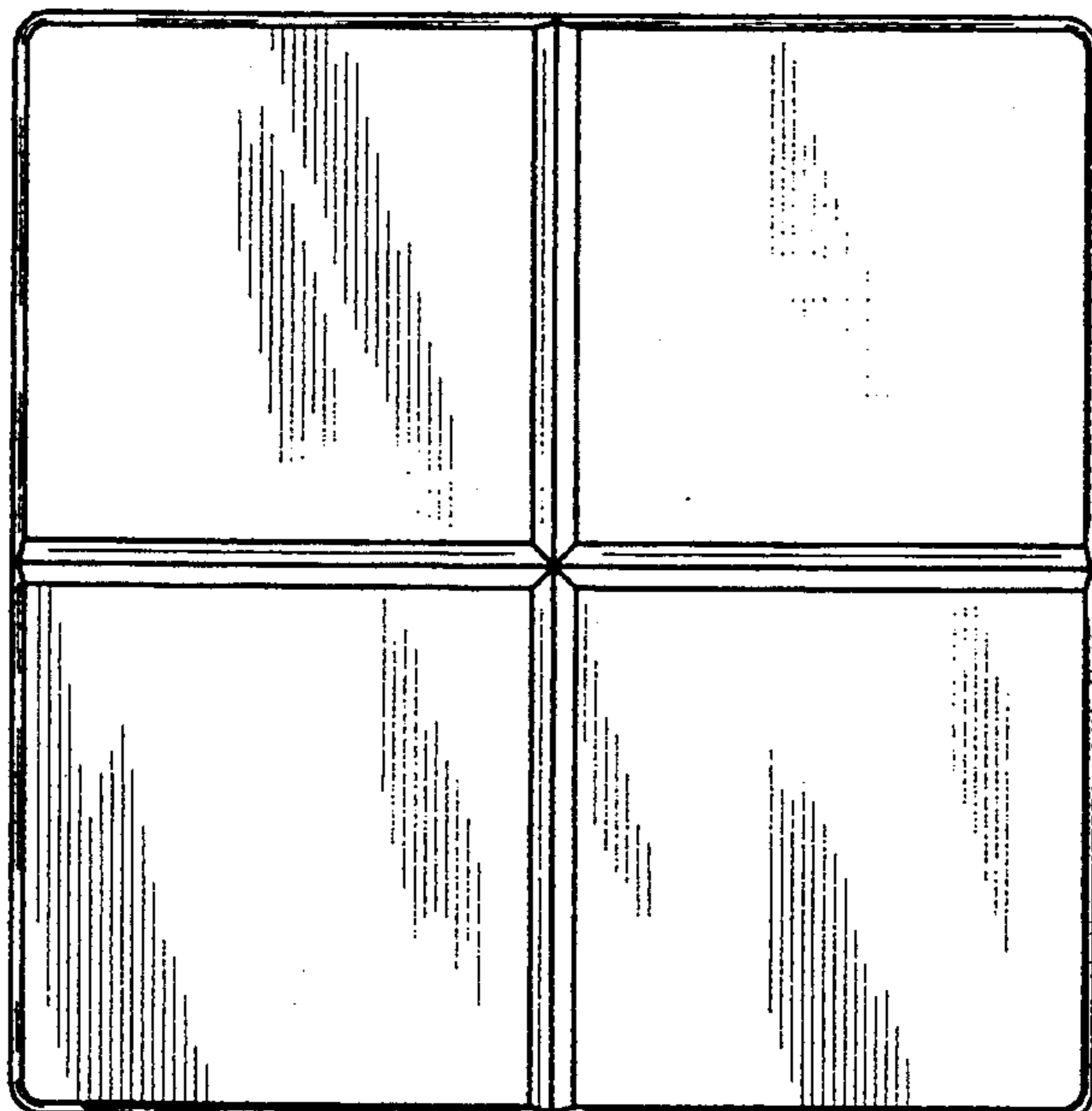

FIG. 7

