



US00D362475S

# United States Patent [19]

[11] Patent Number: **Des. 362,475**

Berres

[45] Date of Patent: **\*\* Sep. 19, 1995**

[54] **NOVELTY INDOOR/OUTDOOR CHILD'S TOY BOAT**

2,456,086	12/1948	Schwall, Jr.	114/345
2,456,637	12/1948	Kearny	440/106
2,483,249	9/1949	Sturtevant	114/345
4,704,981	11/1987	Agner	440/106
5,018,475	5/1991	Burke	D12/316

[76] Inventor: **Sandra R. Berres**, 2211 Salisbury Rd., West Bend, Wis. 53095

[\*\*] Term: **14 Years**

*Primary Examiner*—Terry A. Wallace  
*Assistant Examiner*—R. Barkai  
*Attorney, Agent, or Firm*—David L. Baker; Rhodes & Ascolillo

[21] Appl. No.: **14,489**

[22] Filed: **Oct. 25, 1993**

[52] U.S. Cl. .... **D21/130; D12/316**

### [57] CLAIM

[58] Field of Search ..... D21/71, 73, 130, 108; D12/316, 302; 446/153, 163, 165; 114/345, 347; 440/101, 106

The ornamental design for a novelty indoor/outdoor child's toy boat, as shown.

### DESCRIPTION

### [56] References Cited

#### U.S. PATENT DOCUMENTS

D. 221,395	8/1971	McNett	D21/130
D. 264,860	6/1982	Yamashina	D21/130
D. 267,502	1/1983	Becher et al.	D21/130
1,392,533	10/1921	Smyth	114/345
2,156,175	4/1939	Brown	114/345
2,334,072	11/1943	Cooper	114/345

FIG. 1 is a perspective view of a novelty indoor/outdoor child's toy boat showing my new design therefor; FIG. 2 is a top plan view; FIG. 3 is a front elevational view; FIG. 4 is a rear elevational view; FIG. 5 is a bottom plan view; FIG. 6 is a right side elevational view; and, FIG. 7 is a left side elevational view.

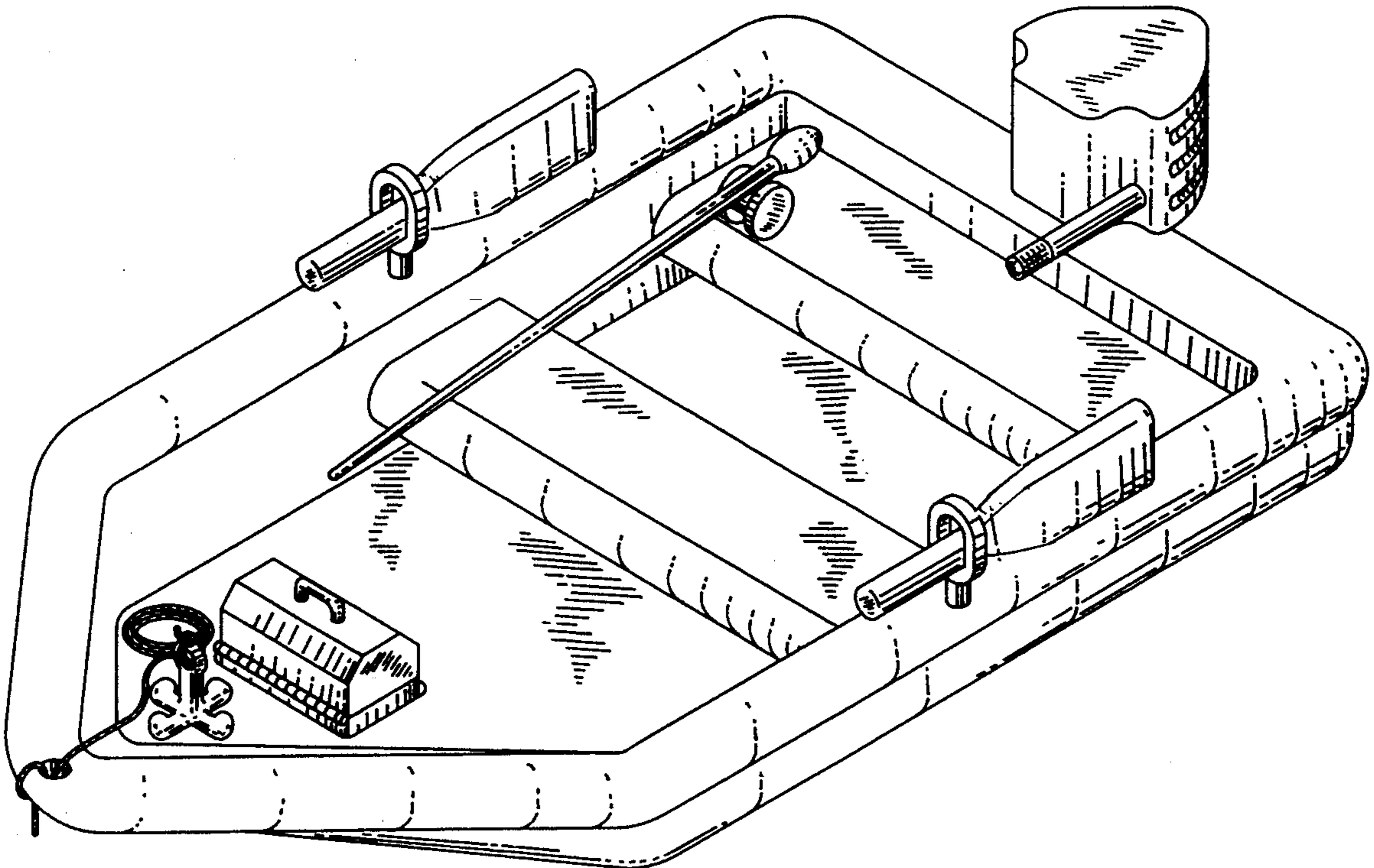

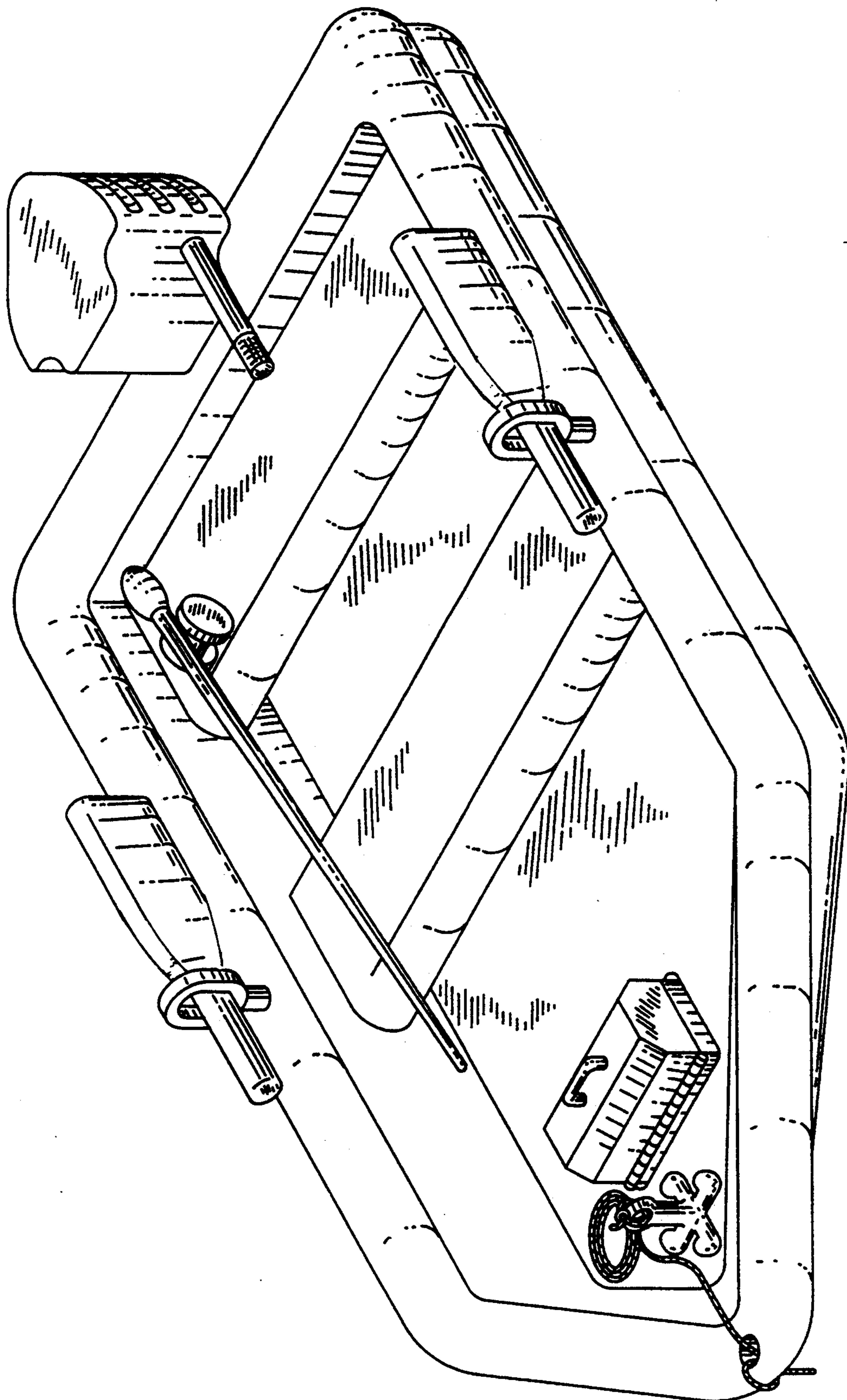

FIGURE 1

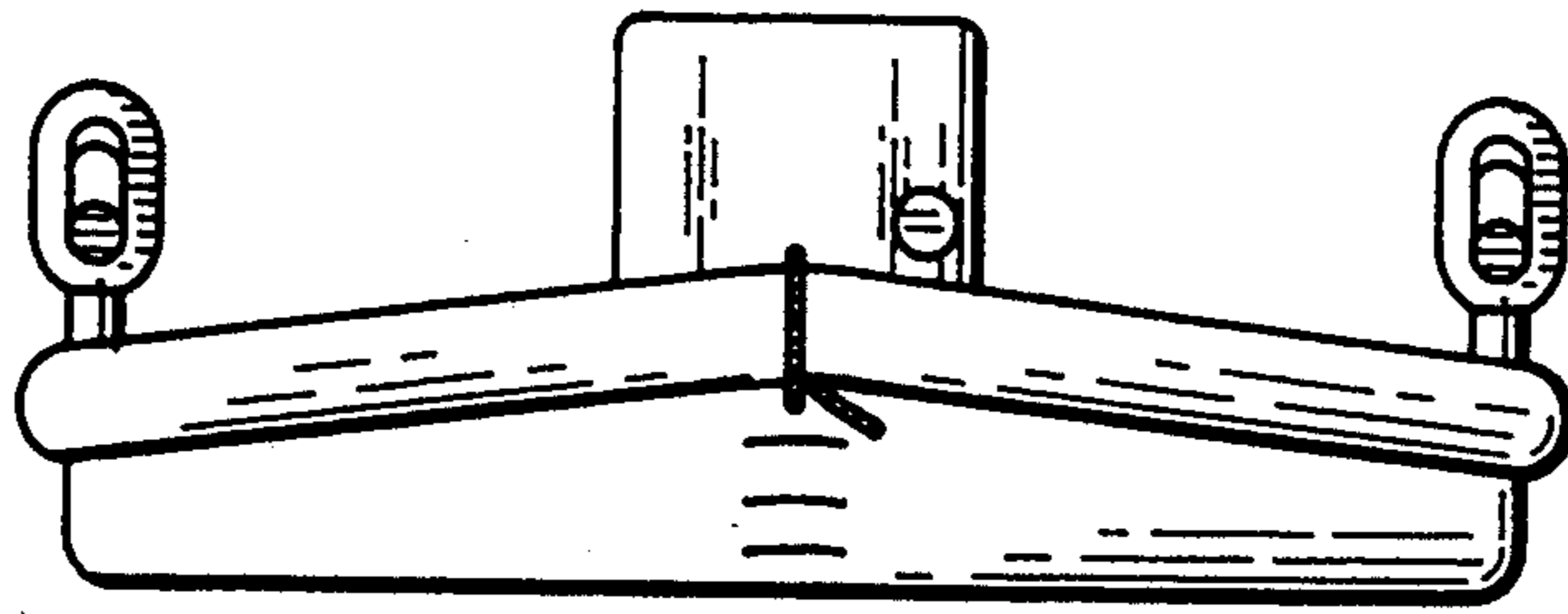

FIGURE 3

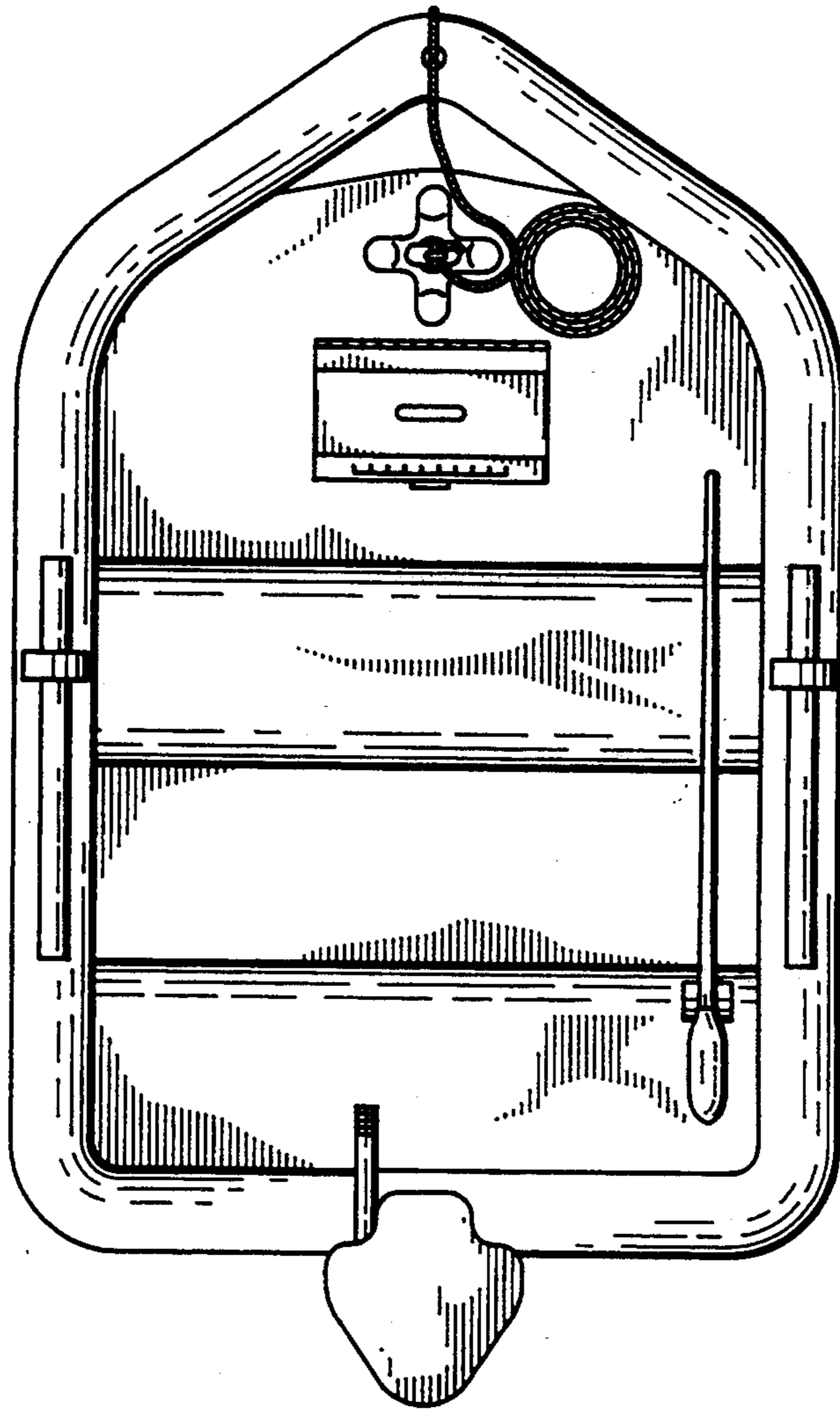

FIGURE 2

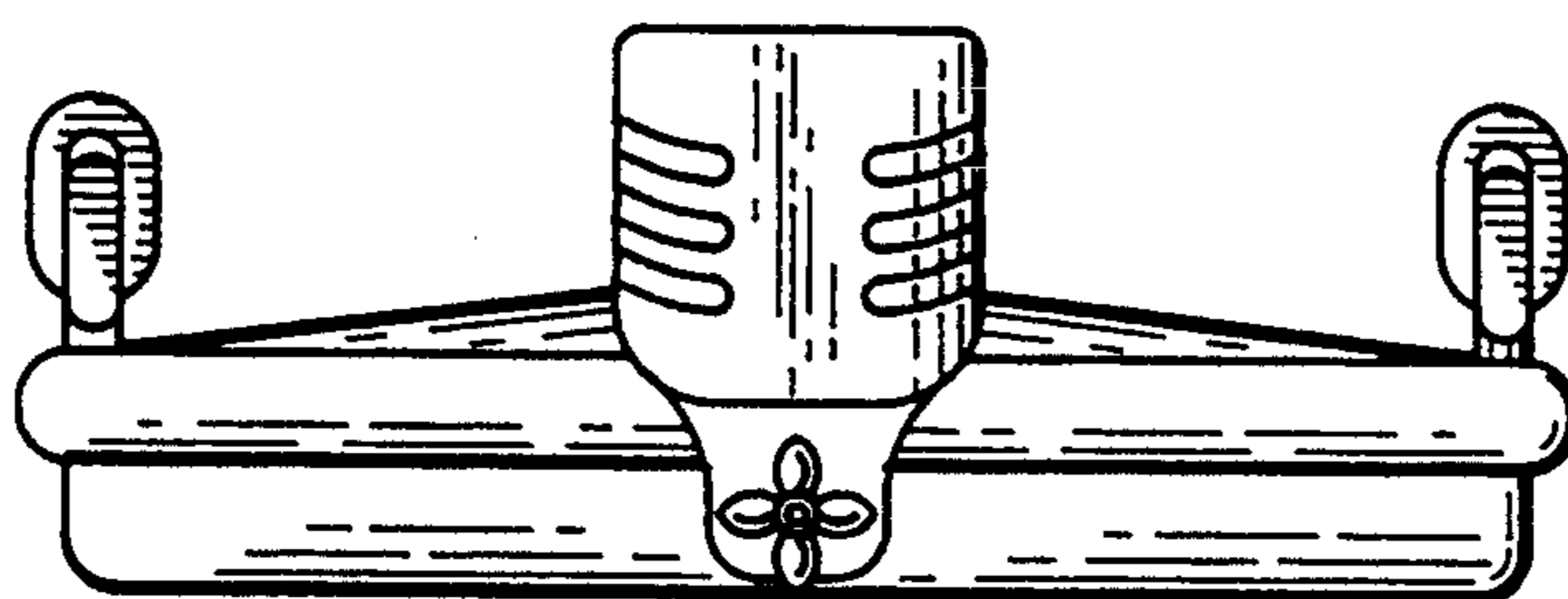

FIGURE 4



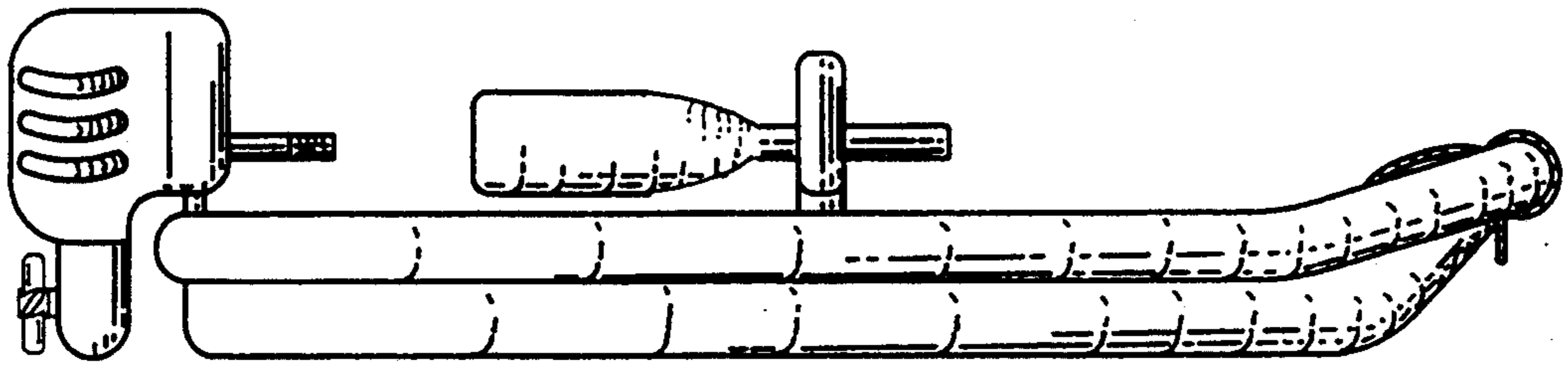

FIGURE 6

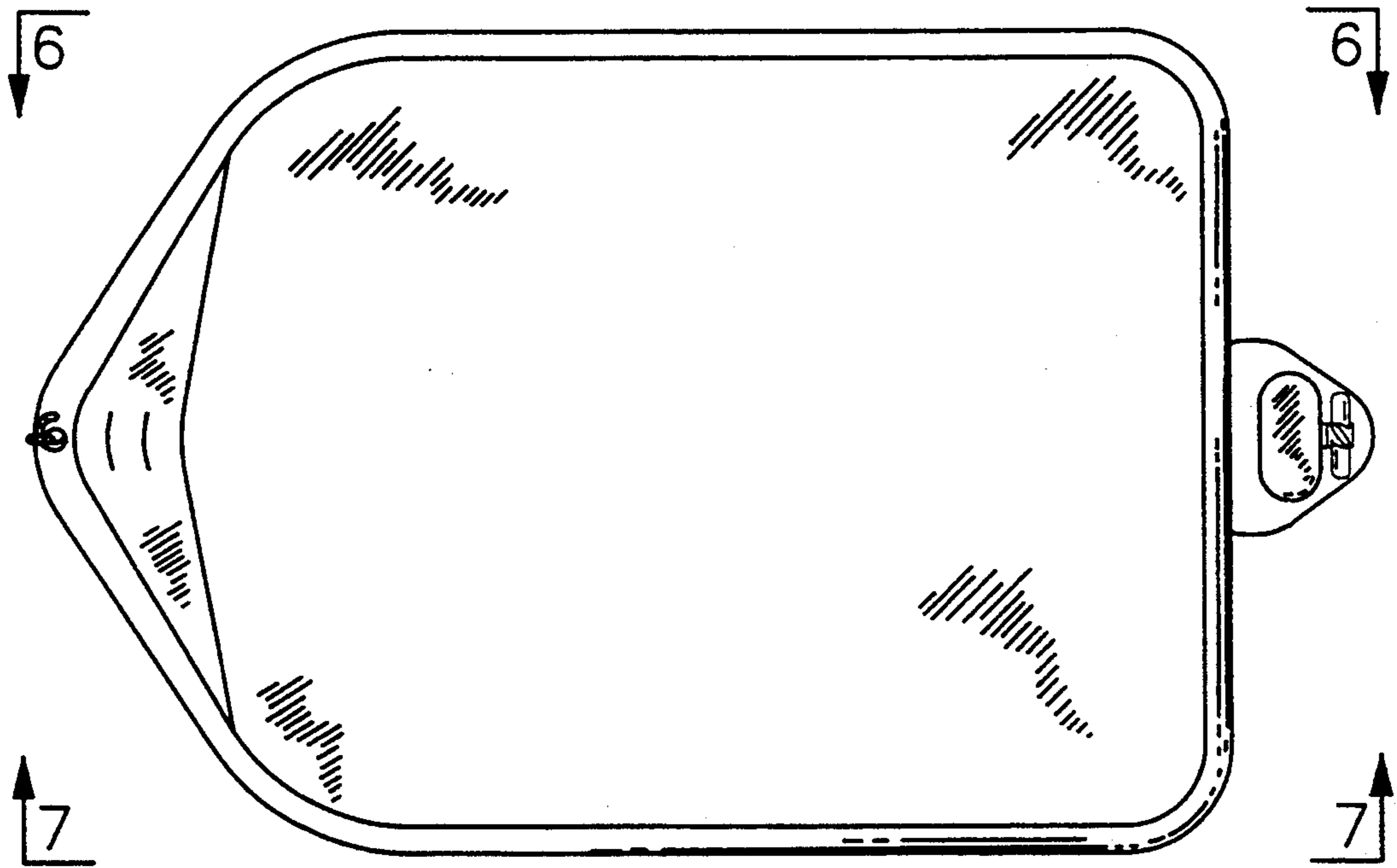

FIGURE 5

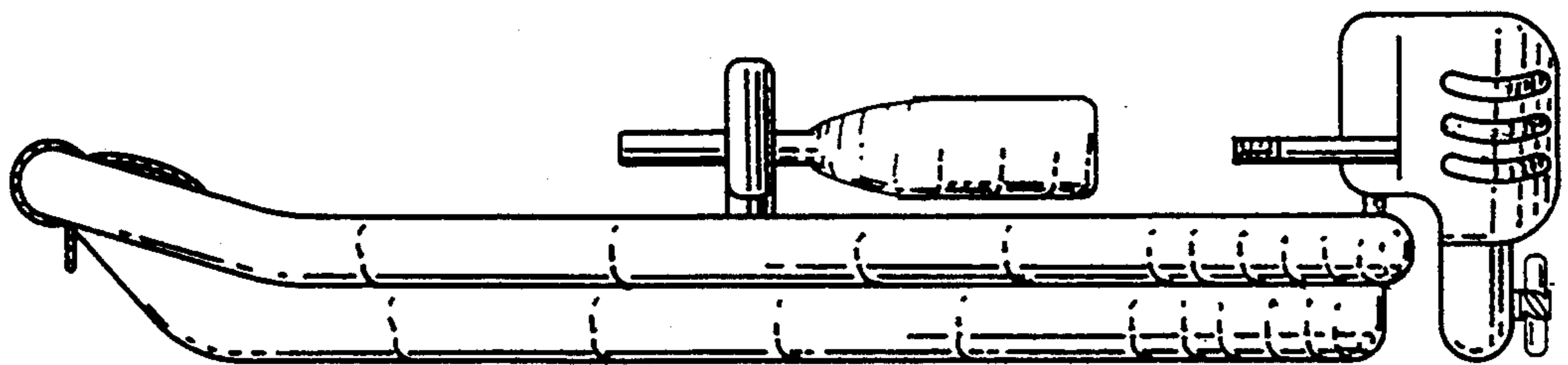

FIGURE 7