



US00D362456S

# United States Patent [19]

[11] Patent Number: **Des. 362,456**

Ishibashi et al.

[45] Date of Patent: **\*\* Sep. 19, 1995**

[54] **COPYING MACHINE**

[75] Inventors: **Masaaki Ishibashi, Hino; Takeshi Komada, Yokosuka, both of Japan**

[73] Assignee: **Canon Kabushiki Kaisha, Tokyo, Japan**

[\*\*] Term: **14 Years**

[21] Appl. No.: **25,096**

[22] Filed: **Jun. 27, 1994**

[30] **Foreign Application Priority Data**

Dec. 29, 1993 [JP] Japan ..... 5-40031

[52] U.S. Cl. .... **D18/39; D18/36**

[58] Field of Search ..... **D18/36-39; D14/111, 112, 116, 118; 355/43-45, 49-51, 66, 162, 200, 210, 231, 233-236, 245; 358/400**

[56] **References Cited**

**U.S. PATENT DOCUMENTS**

D. 276,166	10/1984	Masaki	.....	D18/37
D. 280,630	9/1985	Kadoda	.....	D16/30
D. 299,831	2/1989	Hirata	.....	D18/37
D. 299,926	2/1989	Katada et al.	.....	D18/38
D. 300,749	4/1989	Tokuda	.....	D18/38
D. 313,814	1/1991	Komada et al.	.....	D18/37
D. 316,424	4/1991	Komada et al.	.....	D18/39
D. 316,425	4/1991	Aoyama et al.	.....	D18/39
D. 317,622	6/1991	Isomoto et al.	.....	D18/38

D. 318,486	7/1991	Yamamoto et al.	.....	D18/39
D. 328,094	7/1992	Shimizu et al.	.....	D18/36
D. 328,382	7/1992	Komada et al.	.....	D18/36
D. 328,756	8/1992	Katada et al.	.....	D18/36
D. 334,768	4/1993	Katada et al.	.....	D18/36
D. 334,769	4/1993	Yamamoto et al.	.....	D18/36
D. 334,770	4/1993	Isomoto et al.	.....	D18/39
D. 334,943	4/1993	Suzuki et al.	.....	D18/39
D. 338,031	8/1993	Katada et al.	.....	D18/36
D. 338,226	8/1993	Yamamoto	.....	D18/39
D. 354,076	1/1995	Fukuda et al.	.....	D18/36
D. 354,510	1/1995	Ishibashi et al.	.....	D18/36
4,816,921	3/1989	Alkyama et al.	.....	D18/36 X

*Primary Examiner*—Alan P. Douglas  
*Assistant Examiner*—Caron D. Veynar  
*Attorney, Agent, or Firm*—Fitzpatrick, Cella, Harper & Scinto

[57] **CLAIM**

The ornamental design for a copying machine, as shown and described.

**DESCRIPTION**

FIG. 1 is a front elevational view of a copying machine showing our new design;  
FIG. 2 is a rear elevational view thereof;  
FIG. 3 is a top plan view thereof;  
FIG. 4 is a bottom plan view thereof;  
FIG. 5 is a left side elevational view thereof;  
FIG. 6 is a right side elevational view thereof; and,  
FIG. 7 is a perspective view thereof.

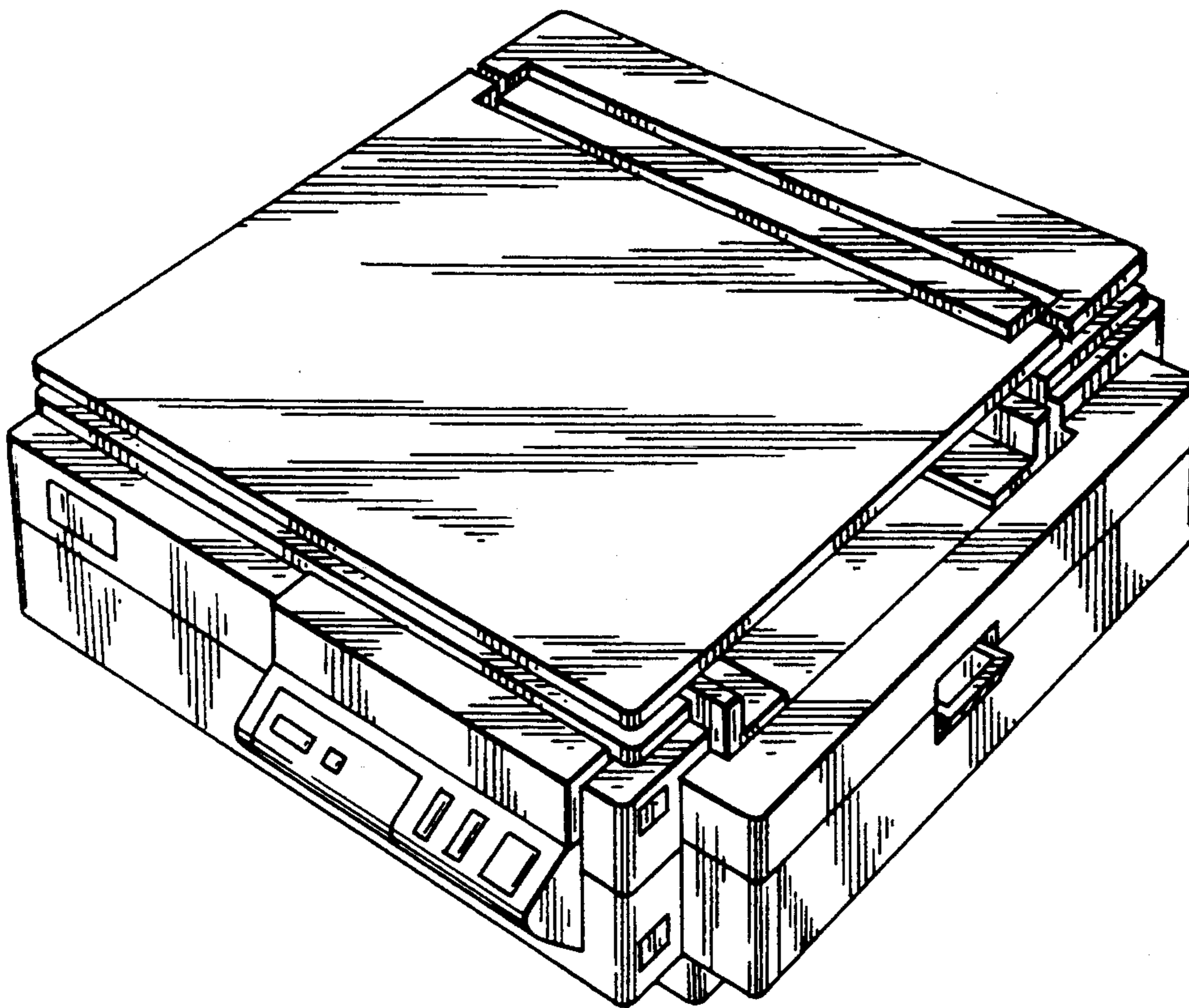

*FIG. 1*

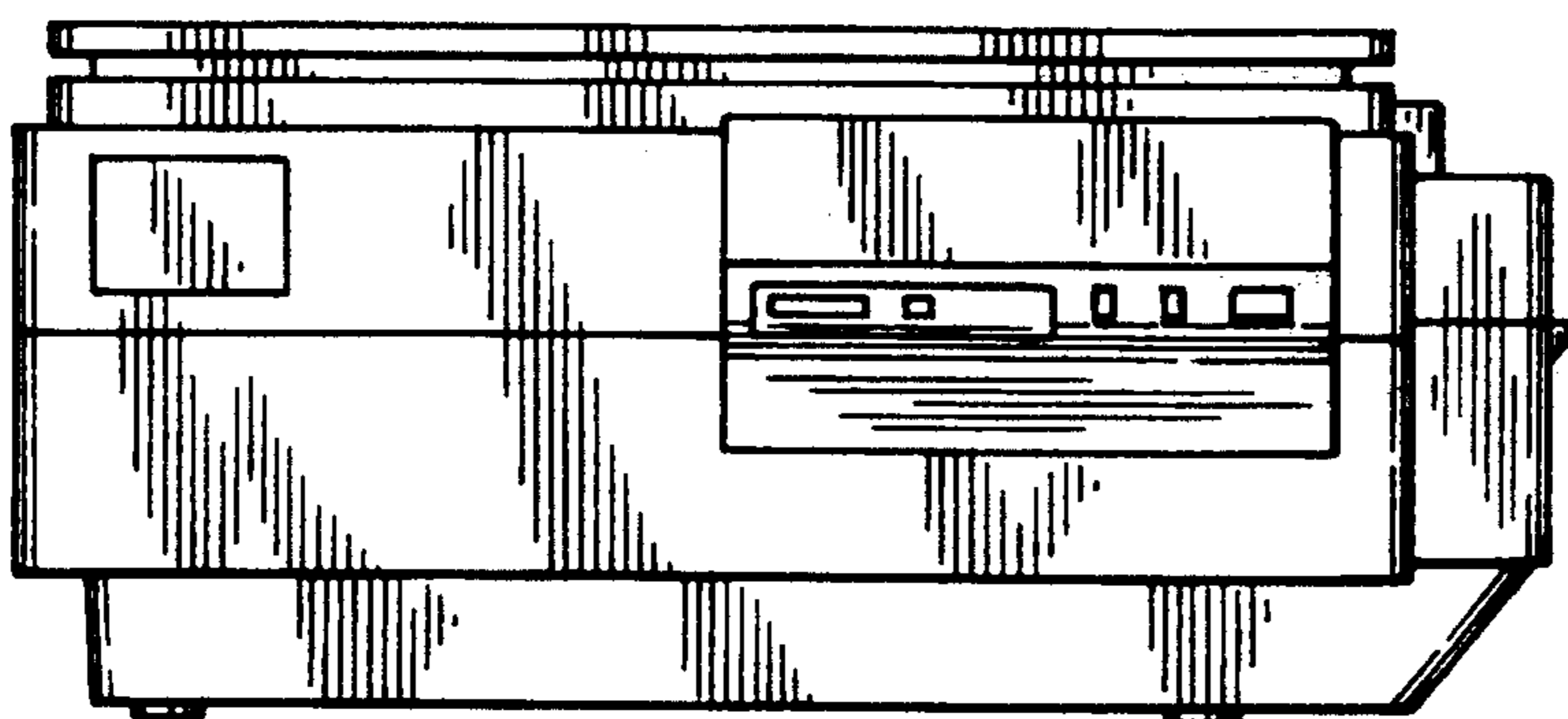

*FIG. 2*

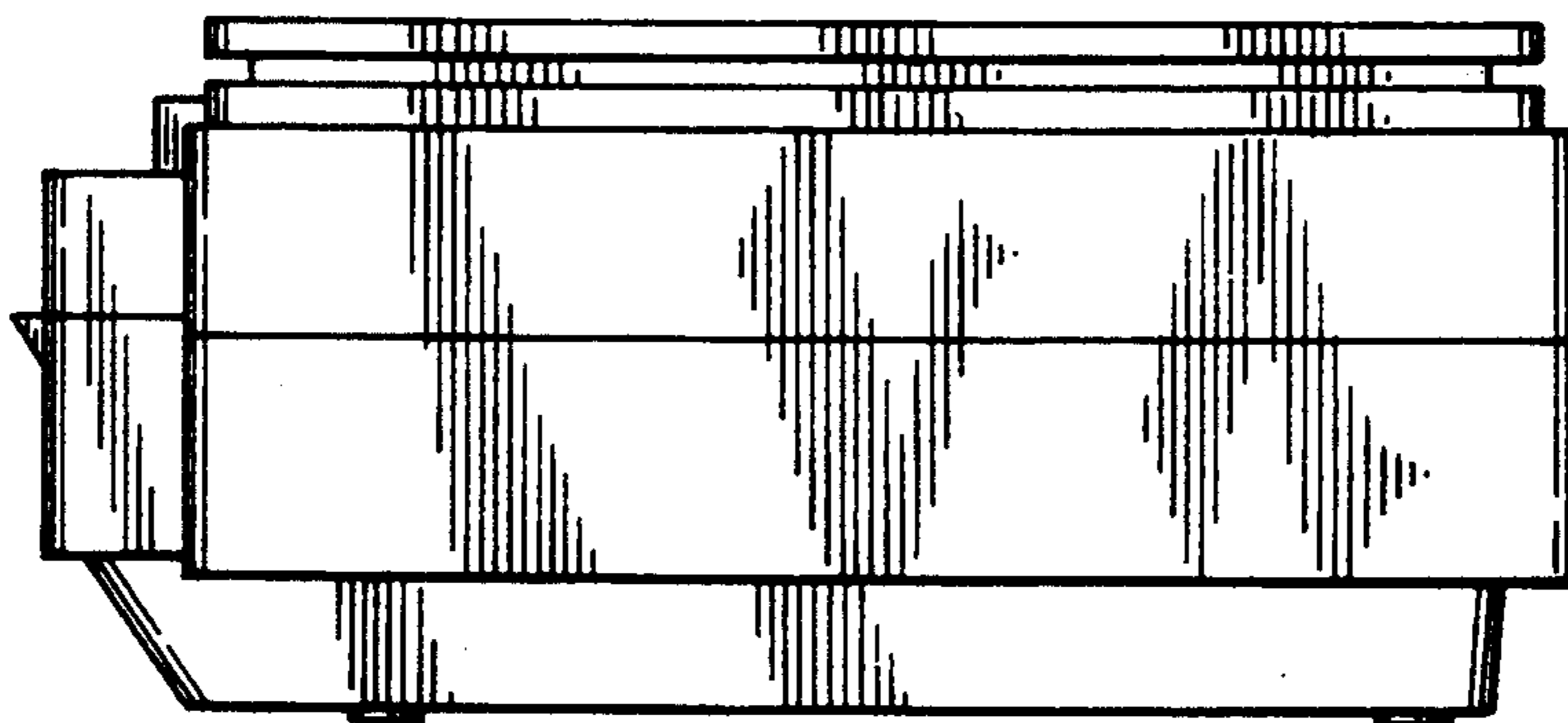

FIG. 3

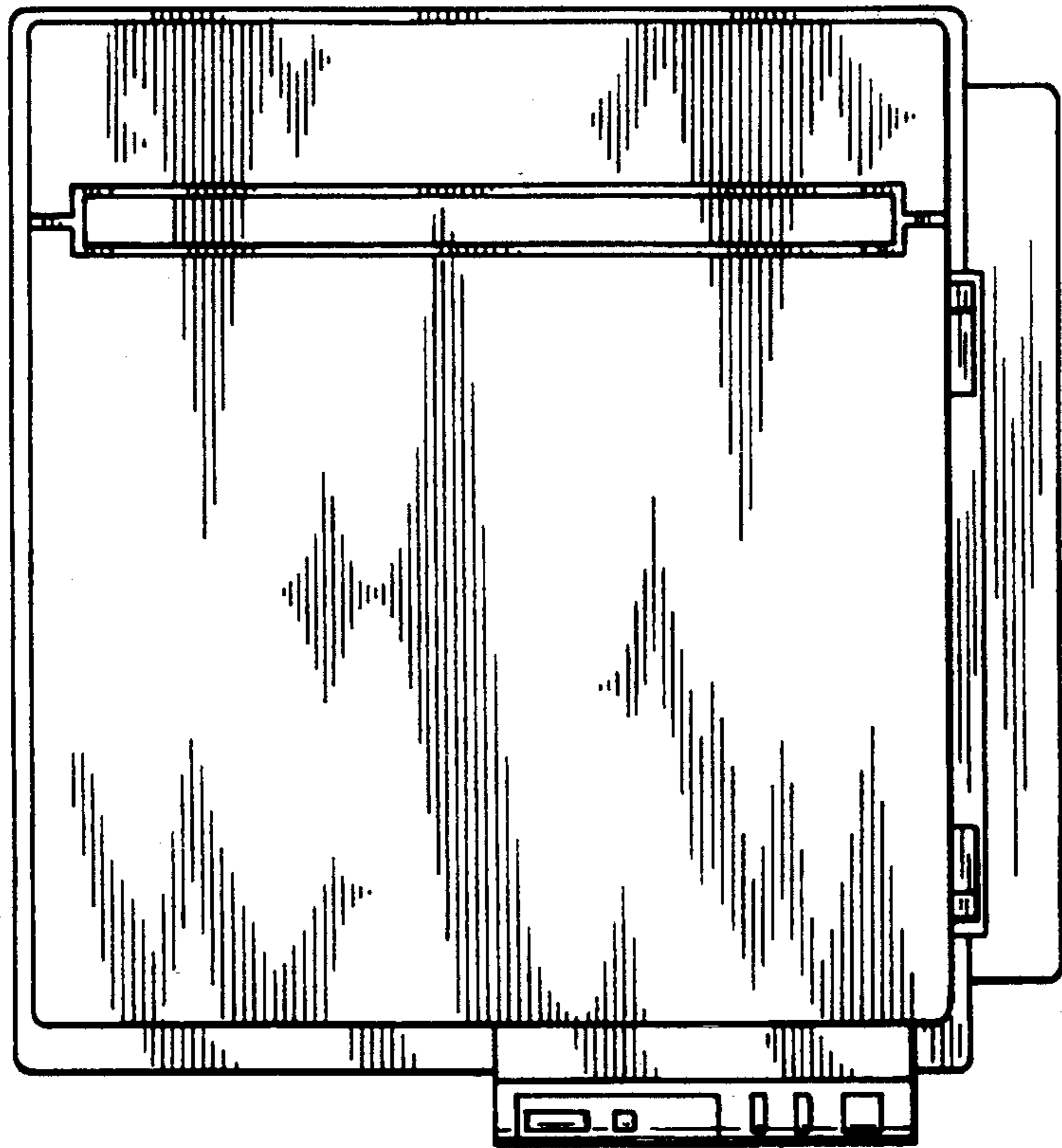
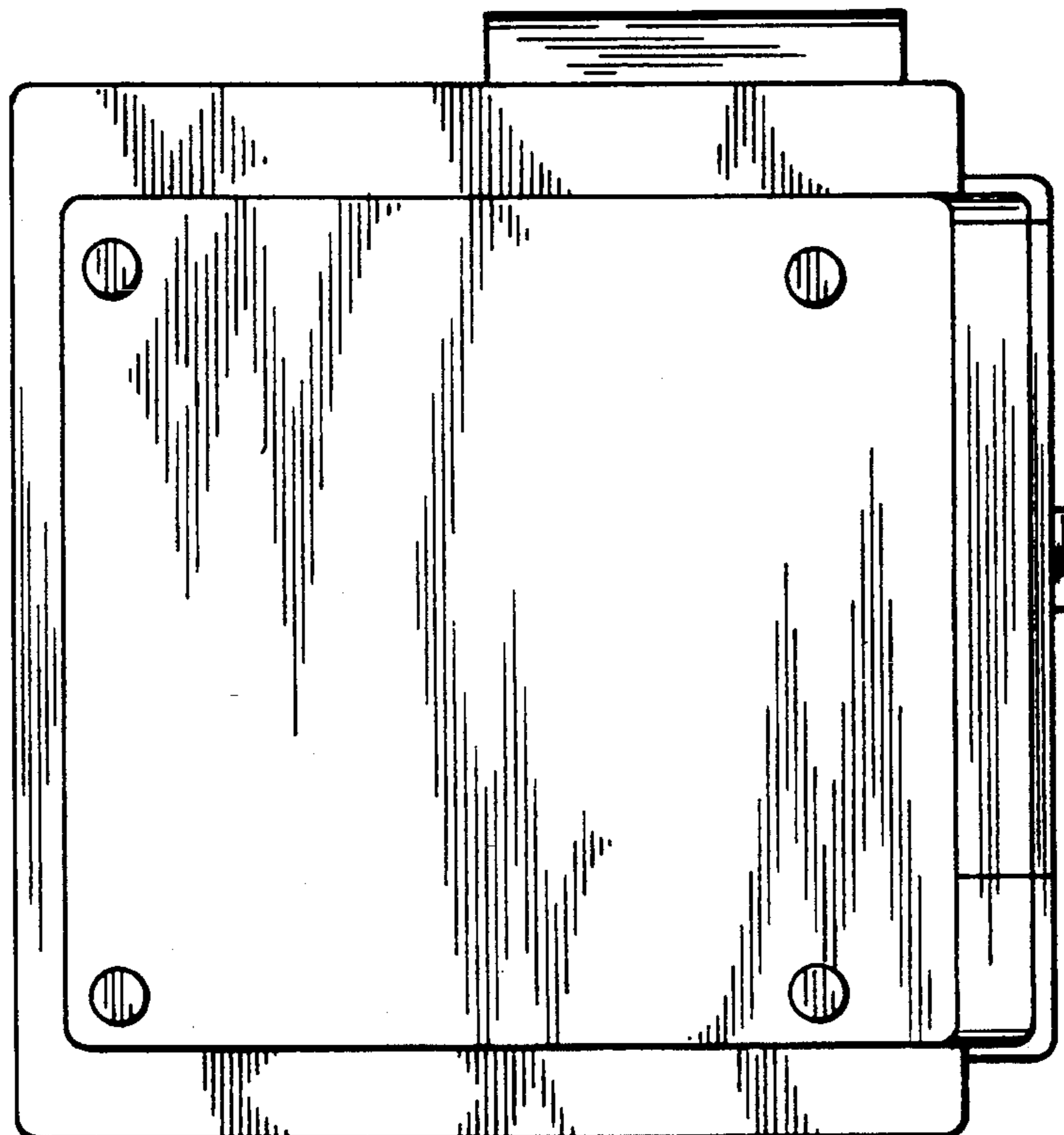
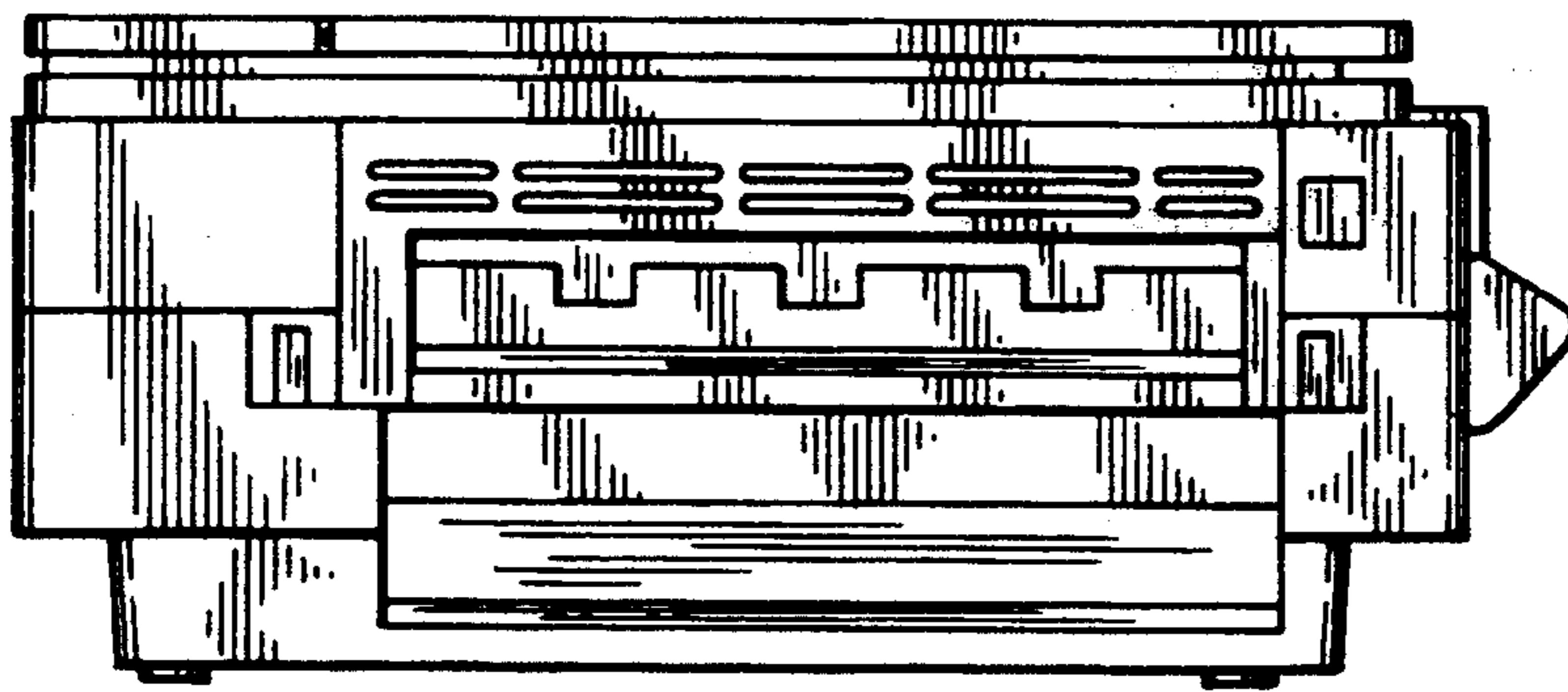

FIG. 4



*FIG. 5*



*FIG. 6*

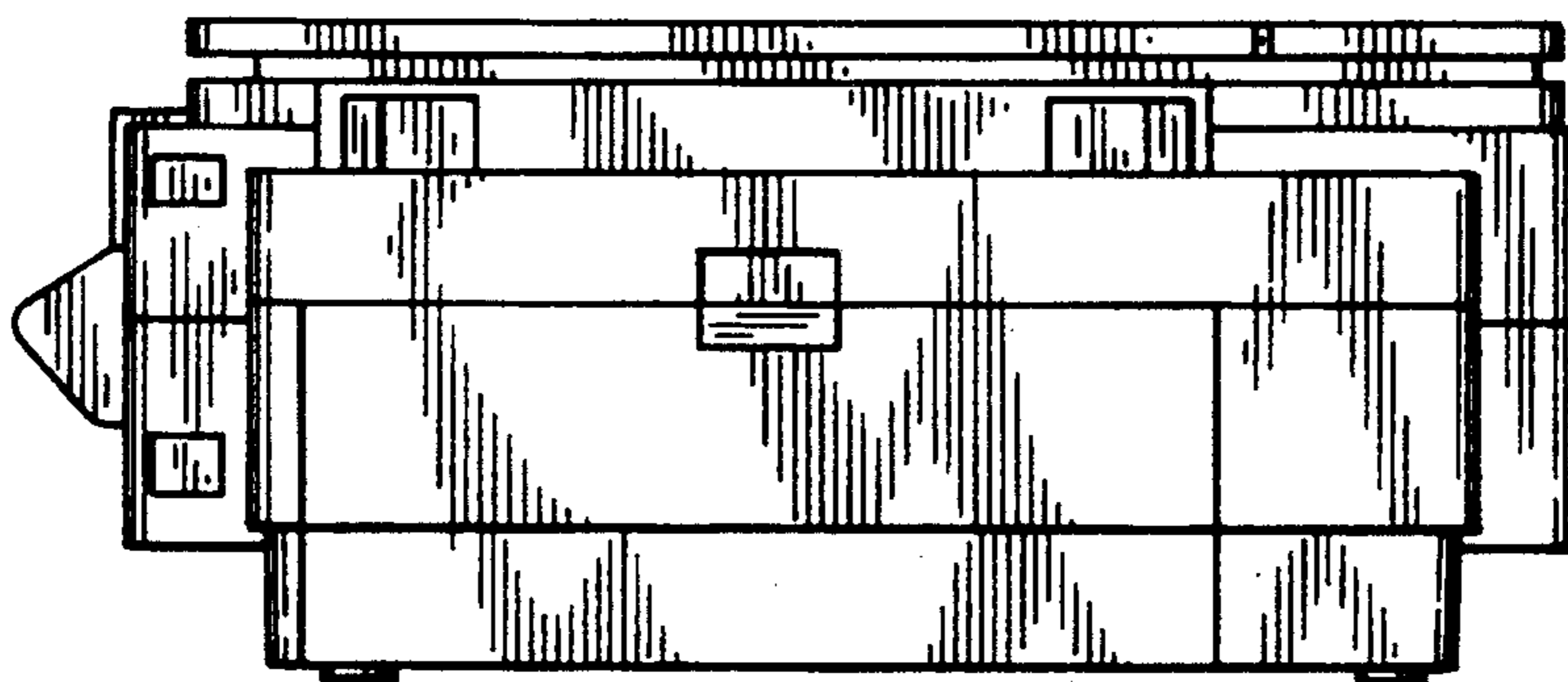

*FIG. 7*

