



US00D362450S

United States Patent [19]

[11] Patent Number: **Des. 362,450**

Bajadali

[45] Date of Patent: **** Sep. 19, 1995**

- [54] **ROCK CRUSHER ANVIL** 4,347,988 9/1982 Warren et al. 241/300
- [75] Inventor: **William J. Bajadali, Veradale, Wash.** 4,355,769 10/1982 Warren et al. 241/275 X
- [73] Assignee: **Spokane Industries, Inc., Spokane, Wash.** 4,659,026 4/1987 Krause et al. 241/275
- [**] Term: **14 Years** 4,699,326 10/1987 Warren 241/275
- [21] Appl. No.: **30,405** 4,756,484 7/1988 Bechler et al. 241/275
- [22] Filed: **Oct. 28, 1994** 5,184,784 2/1993 Rose et al. 241/275
- [52] U.S. Cl. **D15/123; D15/138**
- [58] Field of Search **D15/122, 123, 138, 199; D8/46; 29/283; 241/275, 300**

Primary Examiner—Antoine Duval Davis
Attorney, Agent, or Firm—Wells, St. John, Roberts, Gregory & Matkin

[57] **CLAIM**

The ornamental design for rock crusher anvil, as shown and described.

DESCRIPTION

FIG. 1 is a perspective view of a rock crusher anvil showing my new design;
FIG. 2 is a front elevational view thereof;
FIG. 3 is a rear elevational view thereof;
FIG. 4 is a right side elevational view thereof;
FIG. 5 is a left side elevational view thereof;
FIG. 6 is a bottom view thereof; and,
FIG. 7 is a top view thereof.

[56] **References Cited**

U.S. PATENT DOCUMENTS

D. 254,256	2/1980	Ackers et al.	D15/123
D. 254,257	2/1980	Ackers et al.	D15/123
2,991,949	7/1961	Sellars	241/275
3,168,991	2/1965	Herman	241/275
3,540,667	11/1970	Parker	241/275
4,090,673	5/1978	Ackers et al.	241/275

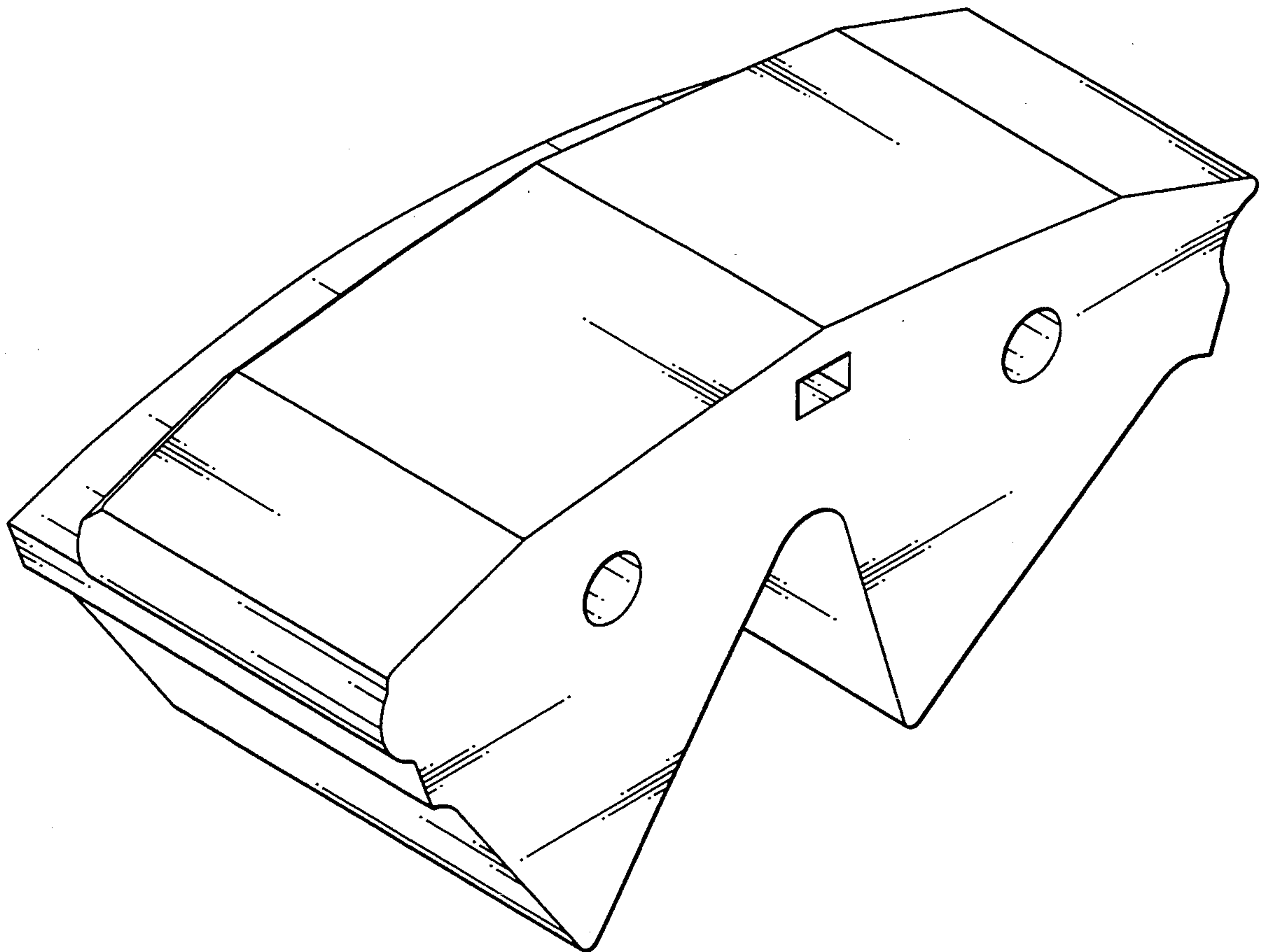

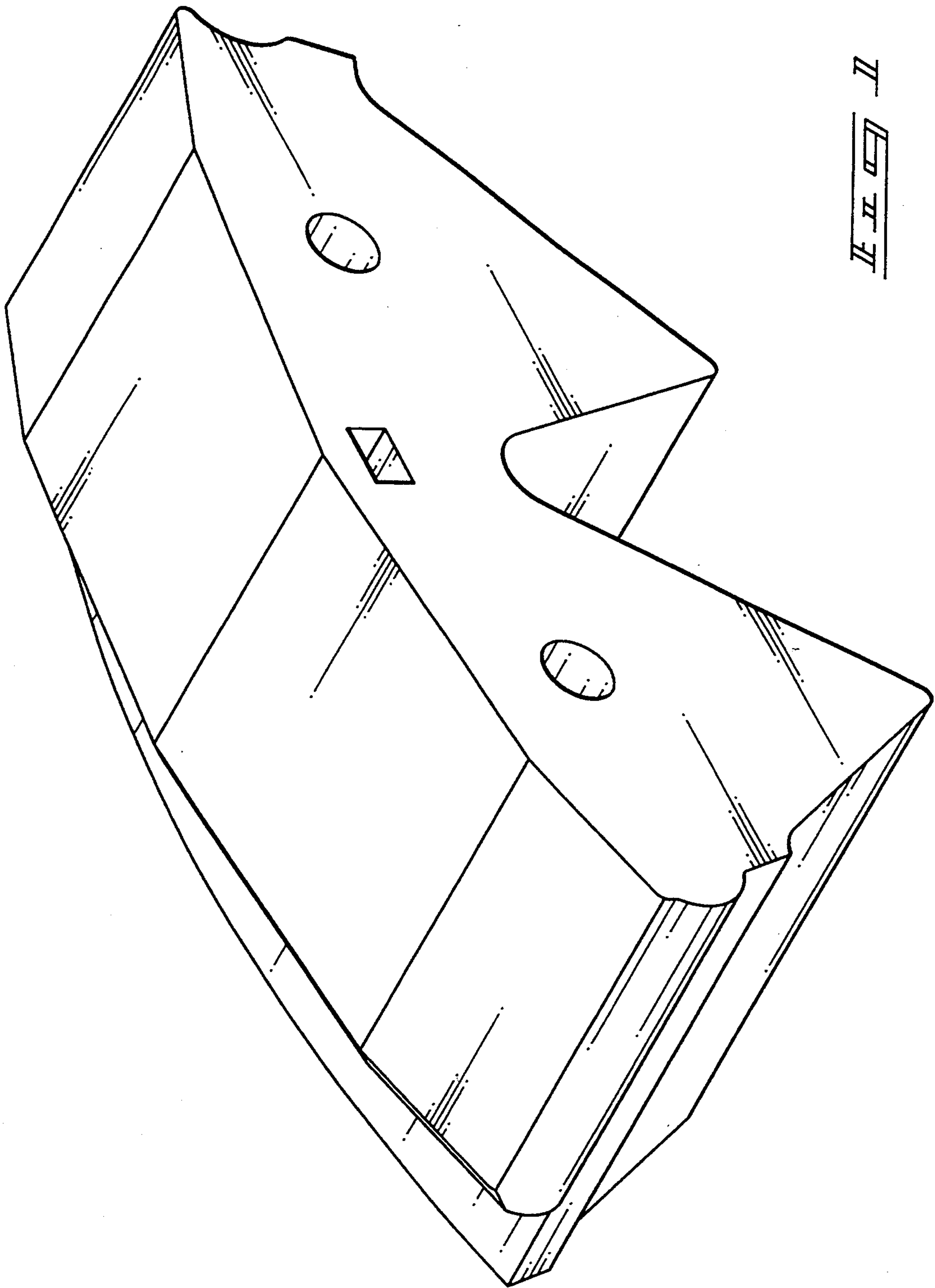

II
II

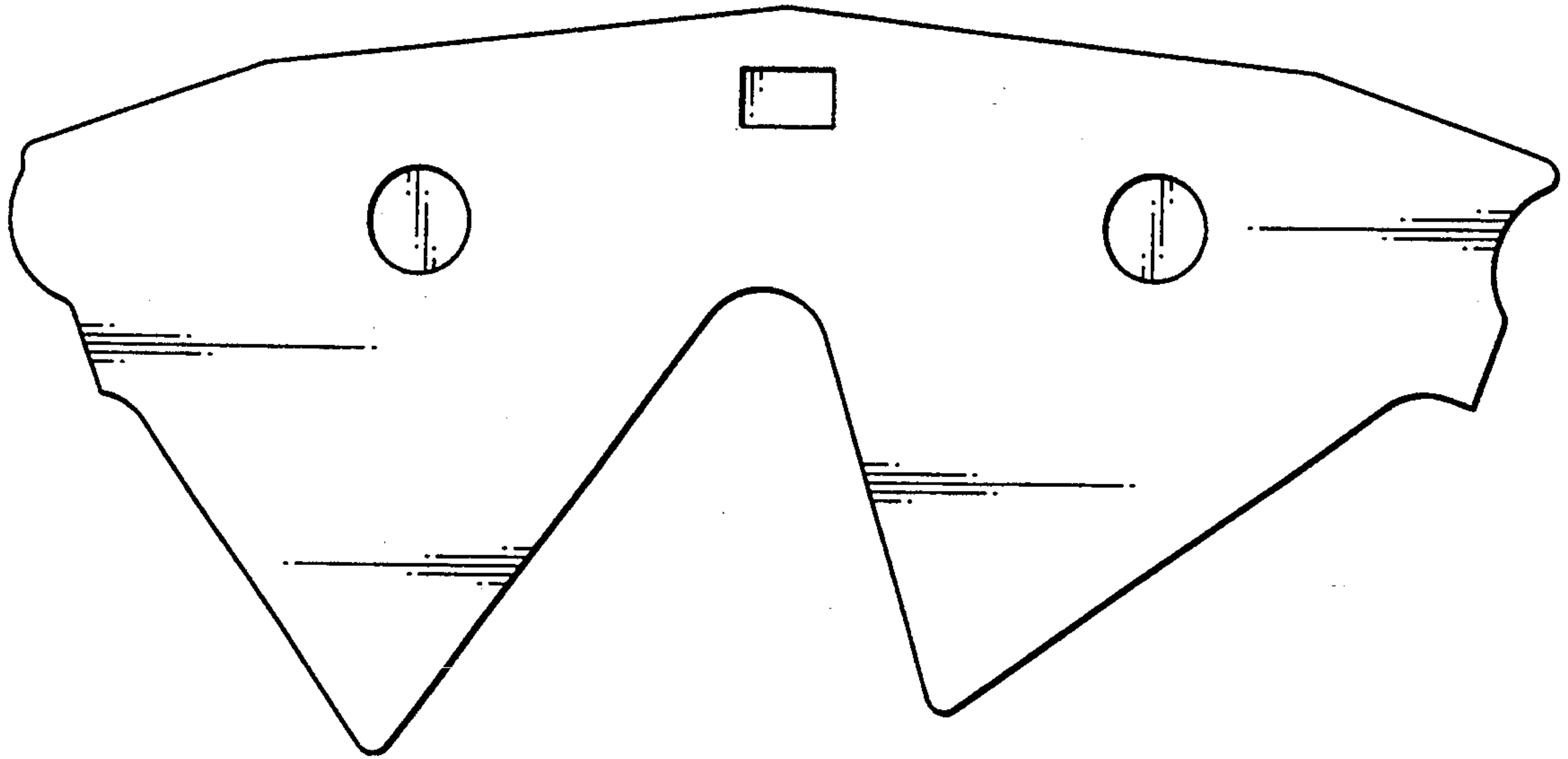

Fig. 2

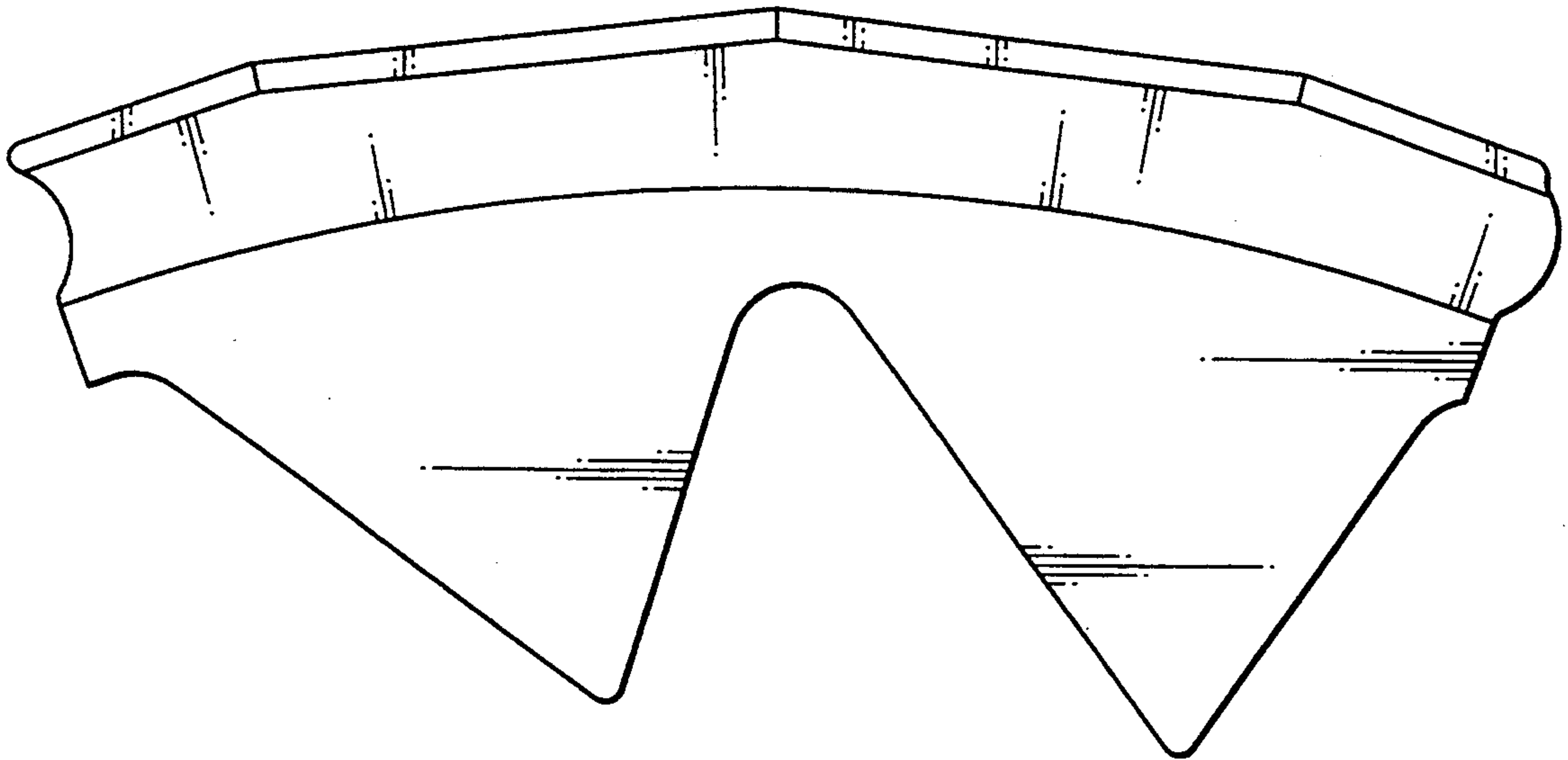

Fig. 3

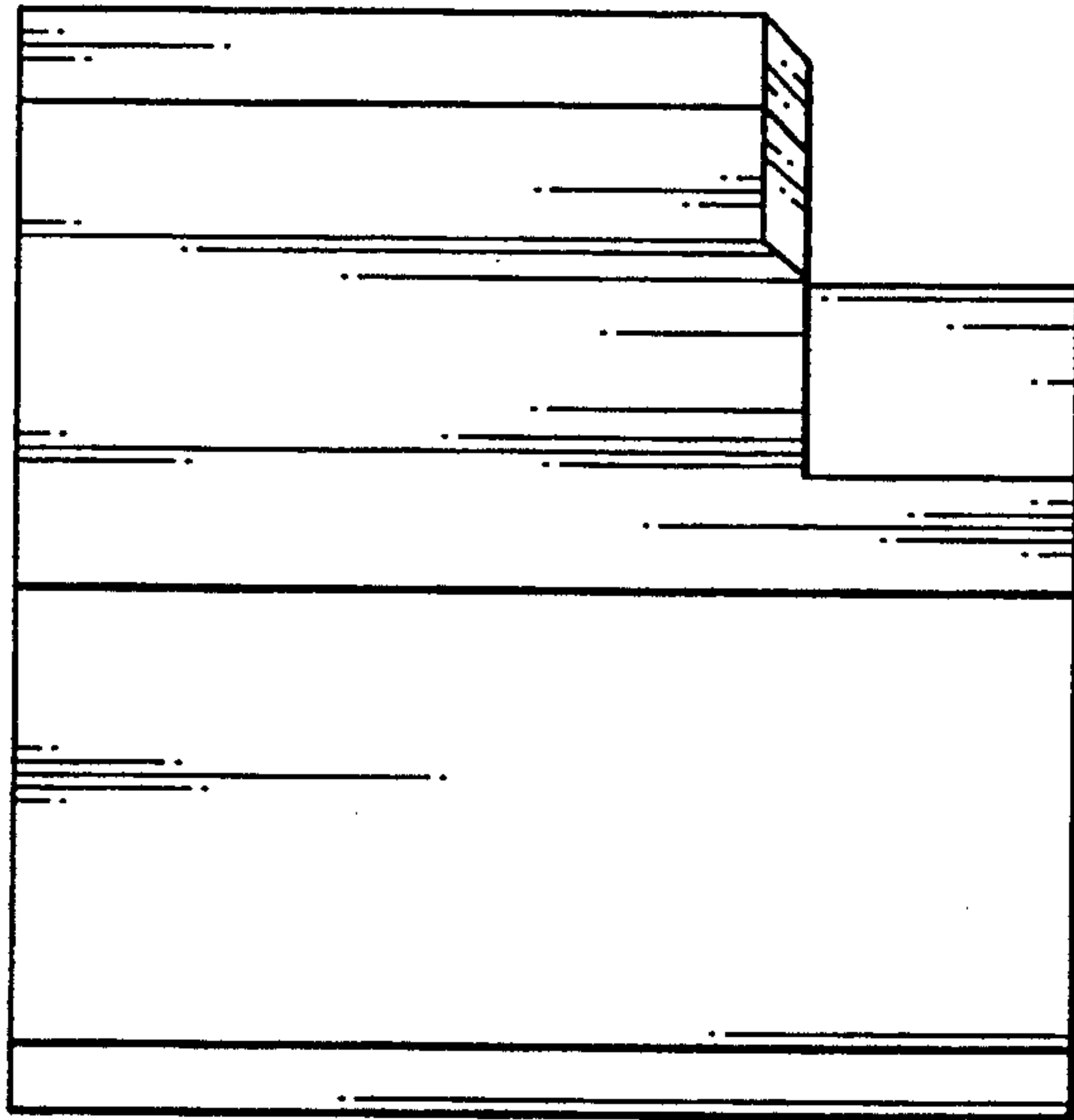

Fig. 4

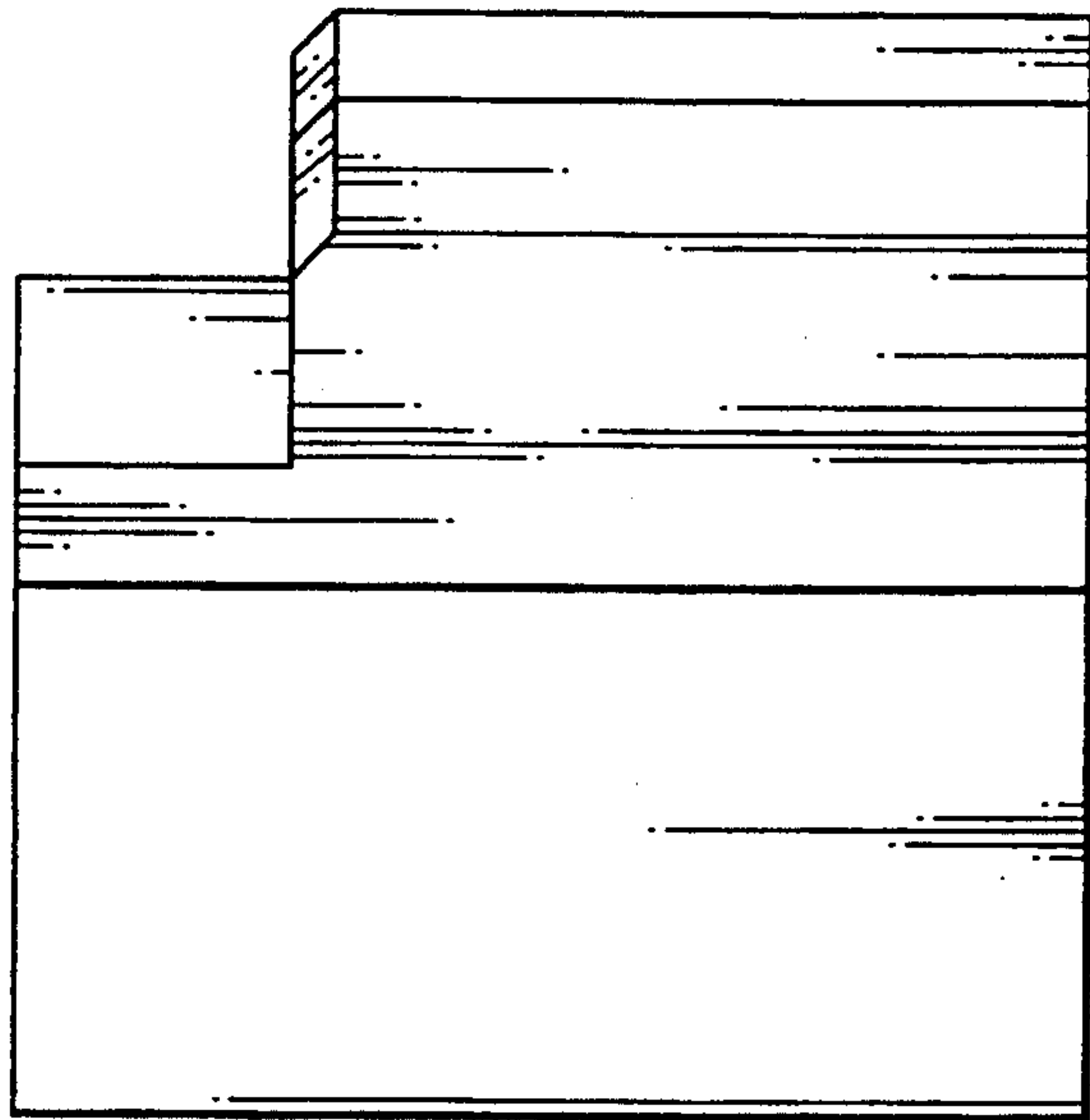

Fig. 5

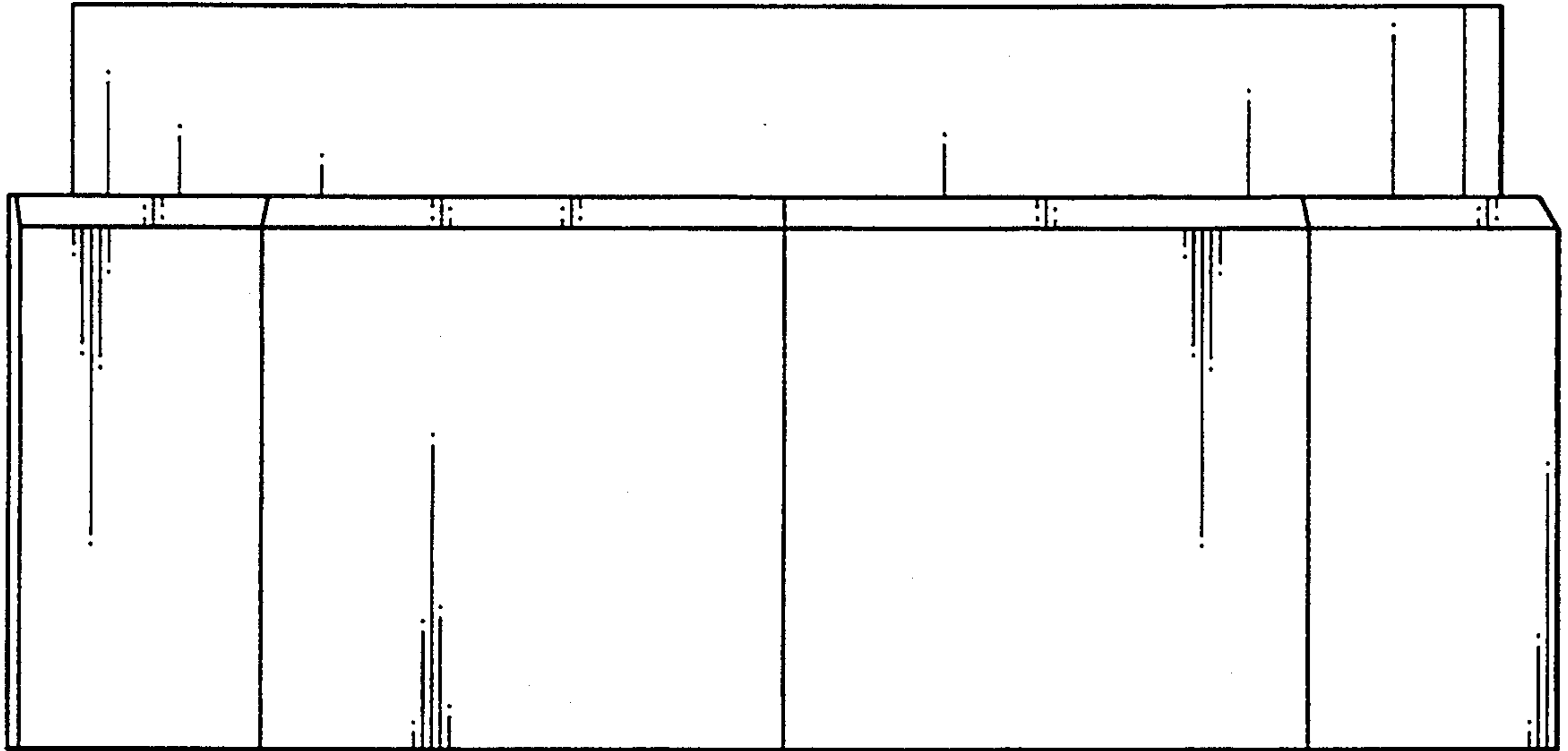

Fig. 4

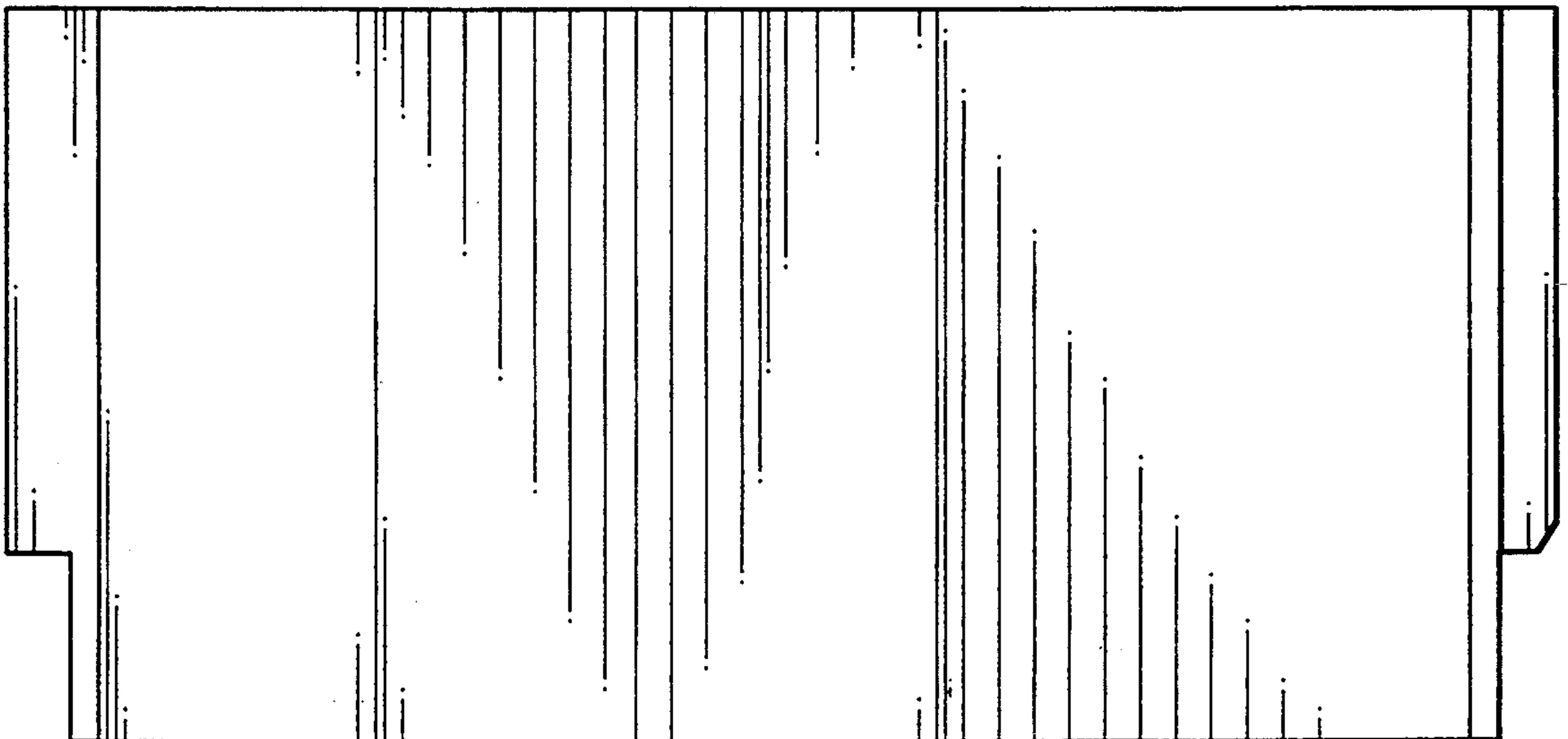

Fig. 5