



US00D362428S

United States Patent [19]

[11] Patent Number: Des. 362,428

Nakada

[45] Date of Patent: ** Sep. 19, 1995

[54] PERSONAL COMPUTER

[57] CLAIM

[75] Inventor: Kazuo Nakada, Kanagawa, Japan

The ornamental design for a personal computer, as shown and described.

[73] Assignee: International Business Machines Corporation, Armonk, N.Y.

DESCRIPTION

[**] Term: 14 Years

FIG. 1 is an enlarged front top and right side perspective view of the personal computer with the cover opened;

[21] Appl. No.: 14,523

FIG. 2 is a front elevational view thereof with the cover opened;

[22] Filed: Oct. 22, 1993

FIG. 3 is a rear elevational view thereof with the cover opened;

[30] Foreign Application Priority Data

Apr. 28, 1993 [JP] Japan 5-12483 U

FIG. 4 is a top plan view thereof with the cover opened;

[52] U.S. Cl. D14/106

FIG. 5 is a bottom plan view thereof with the cover opened;

[58] Field of Search D14/100, 101, 106, 113,

D14/115, 124-127; D18/1, 2, 7, 11, 12;

235/145 A, 145 R; 341/22, 23; 345/104, 156,

168, 173, 87, 901-905; 361/679-686; 364/708.1,

709.04, 709.12; 400/486, 489

FIG. 6 is a left side elevational view thereof with the cover opened;

FIG. 7 is a right side elevational view thereof with the cover opened;

FIG. 8 is an enlarged front top and side perspective view of the personal computer with the cover closed;

FIG. 9 is a front elevational view thereof with the cover closed;

[56] References Cited

U.S. PATENT DOCUMENTS

D. 317,759 6/1991 Azima D14/106

D. 341,579 11/1993 Sugihara et al. D14/106

D. 346,592 5/1994 High et al. D14/106

FIG. 10 is a rear elevational view thereof with the cover closed;

FIG. 11 is a top plan view thereof with the cover closed;

FIG. 12 is a bottom plan view thereof with the cover closed;

FIG. 13 is a left side elevational view thereof with the cover closed; and,

FIG. 14 is a right side elevational view thereof with the cover closed.

Primary Examiner—Freda S. Nunn

Attorney, Agent, or Firm—Martin J. McKinley; Andrew J. Dillon

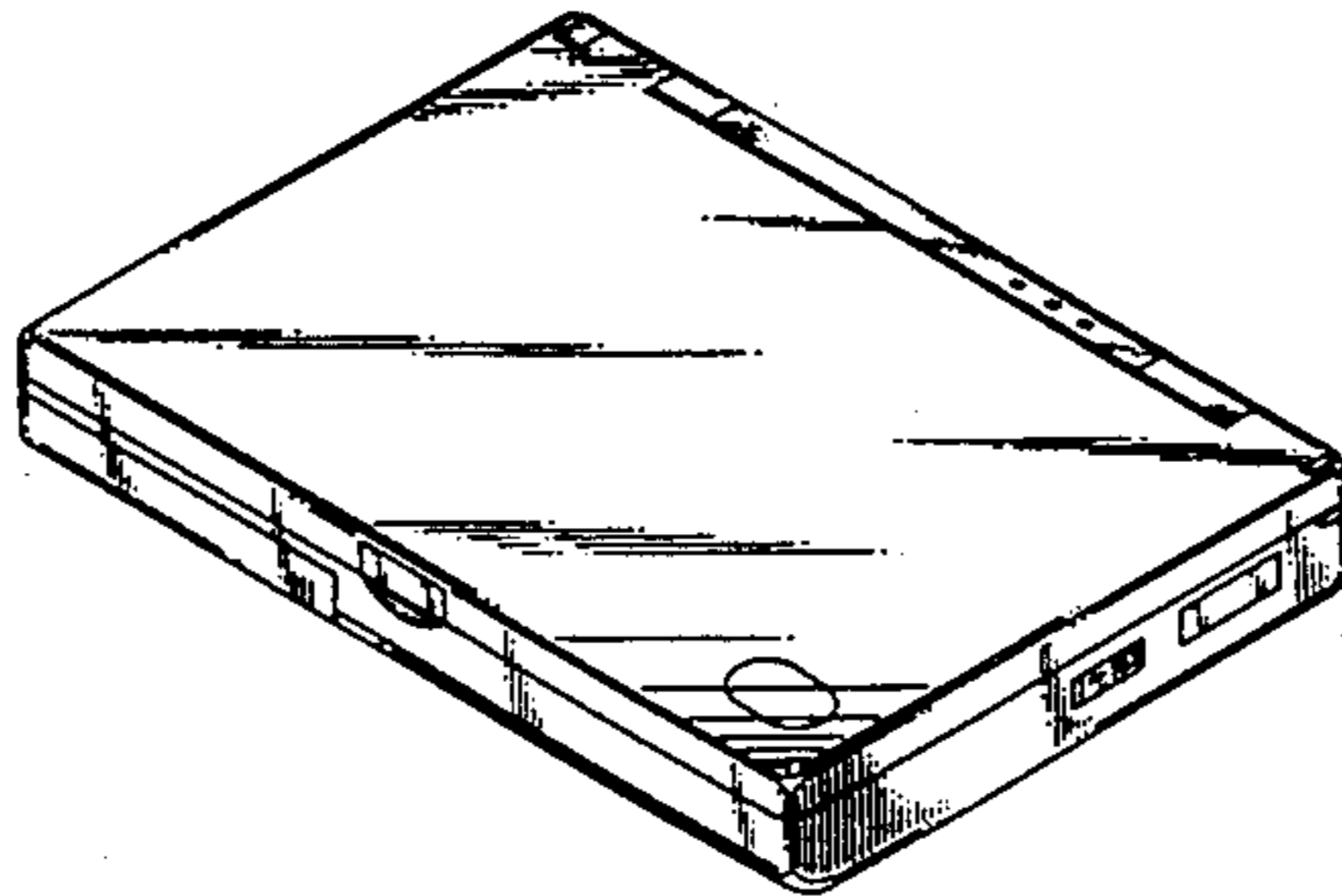
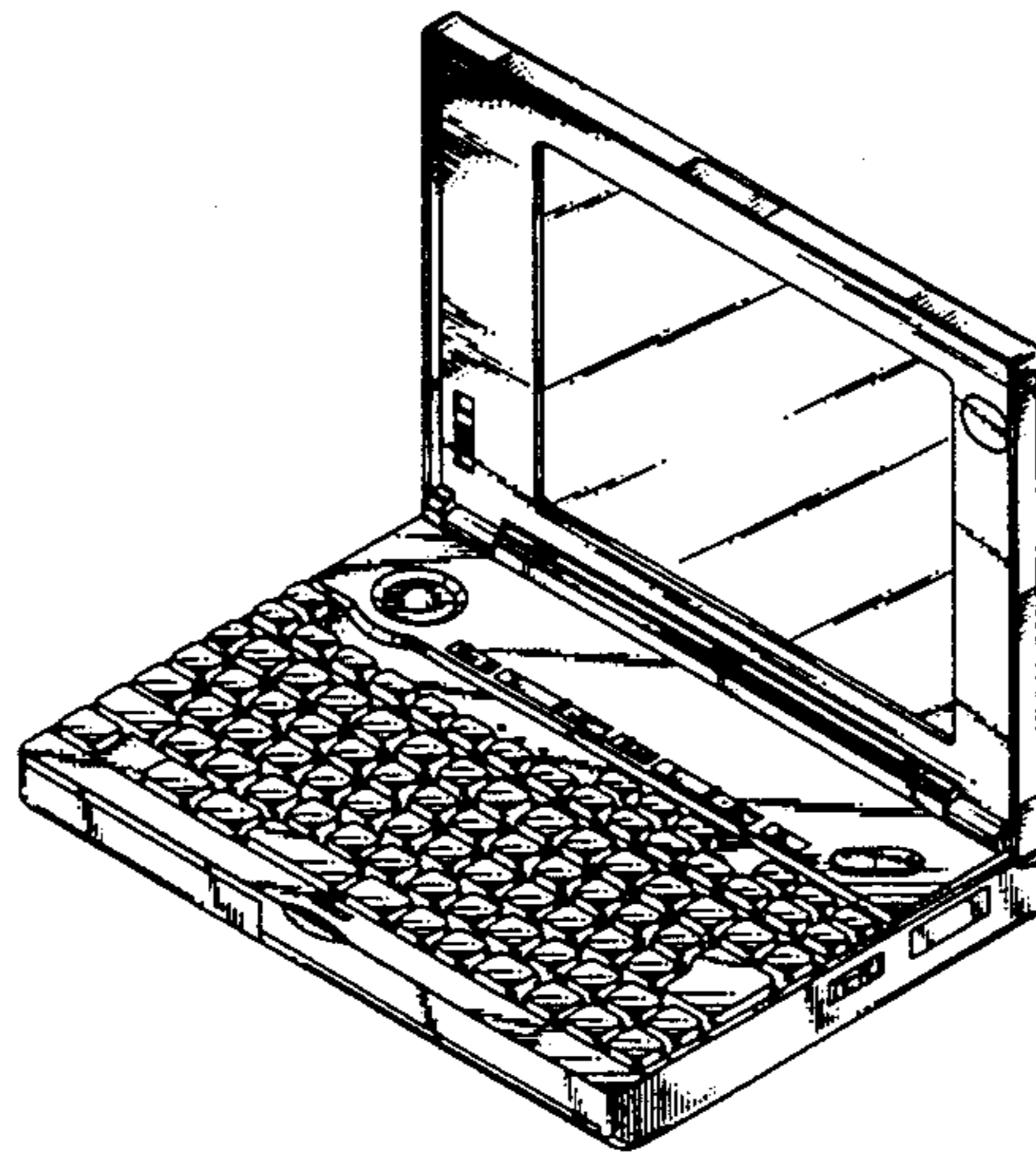

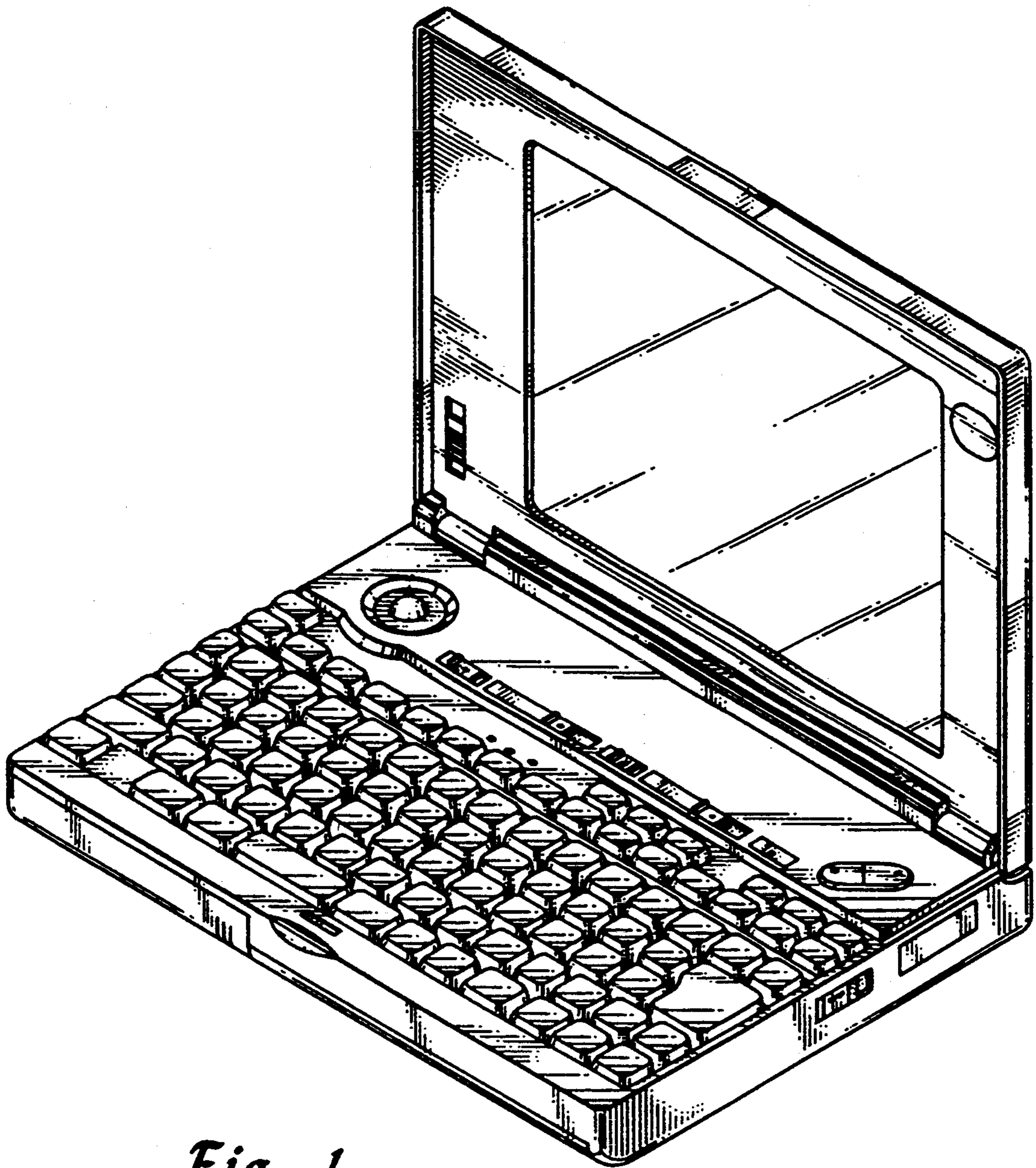
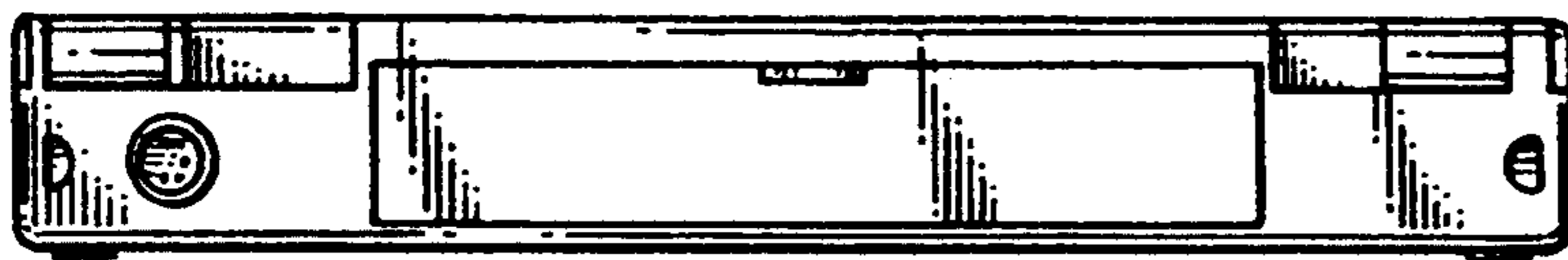

Fig. 1

Fig. 10



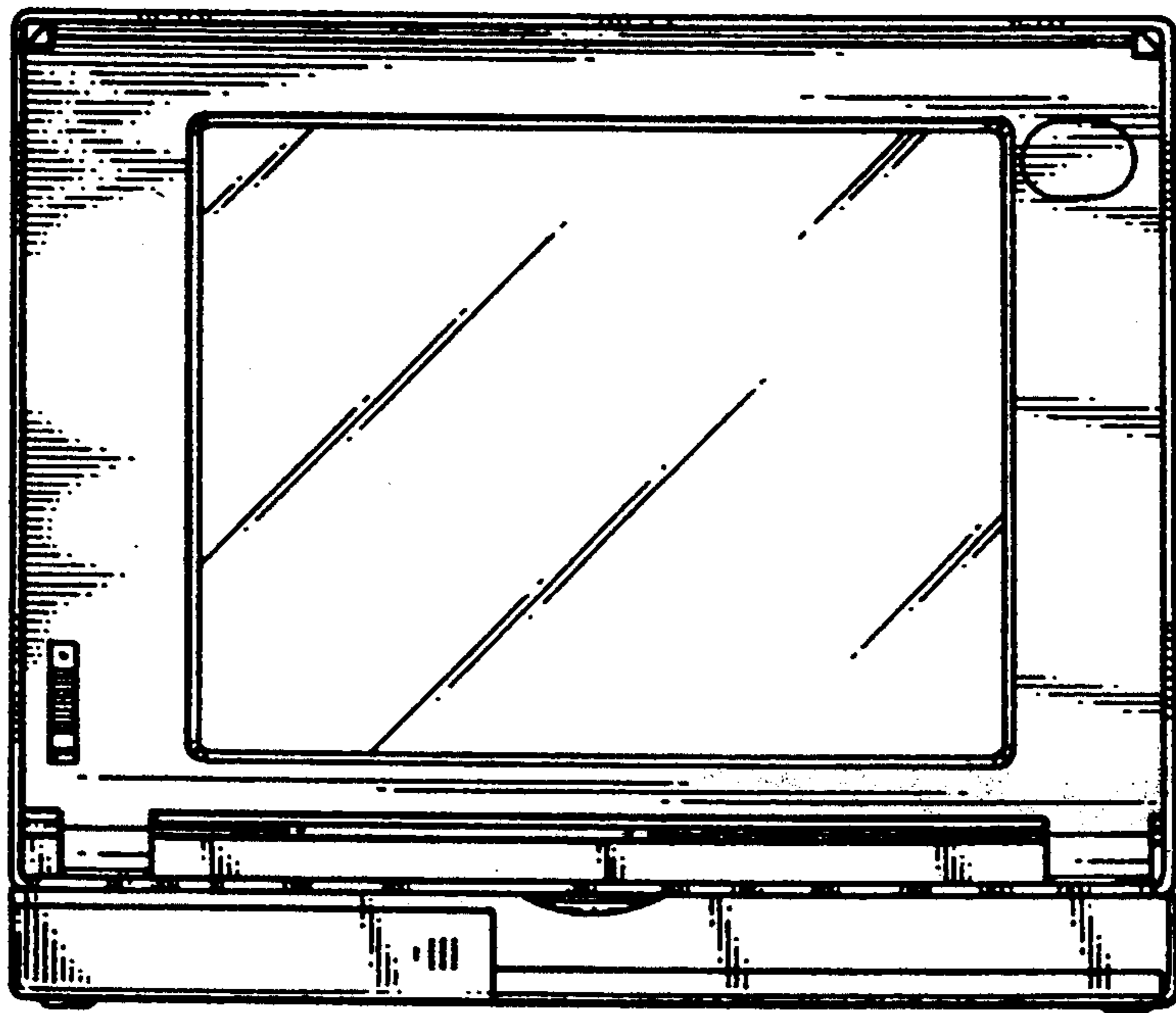

Fig. 2

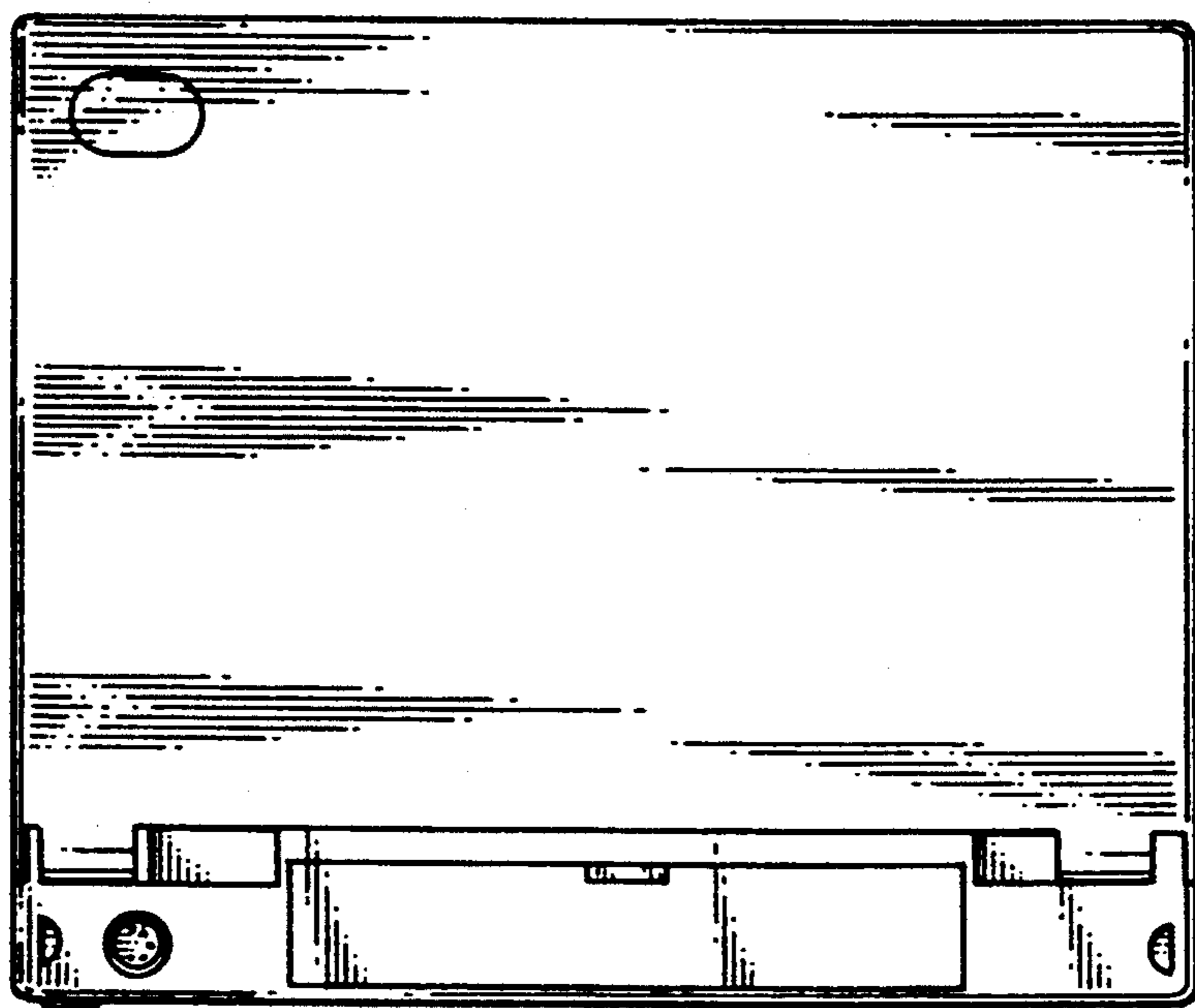

Fig. 3

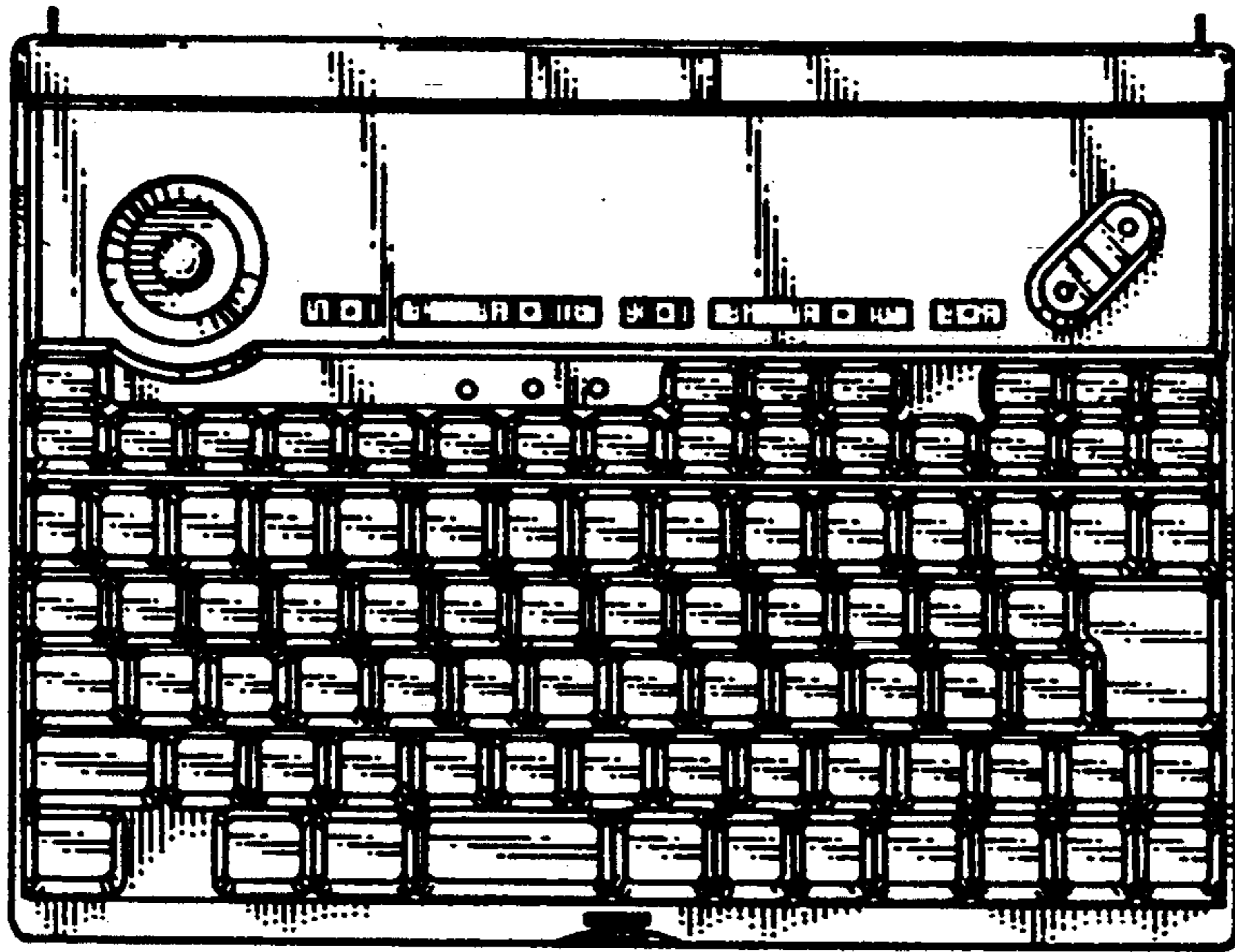

Fig. 4

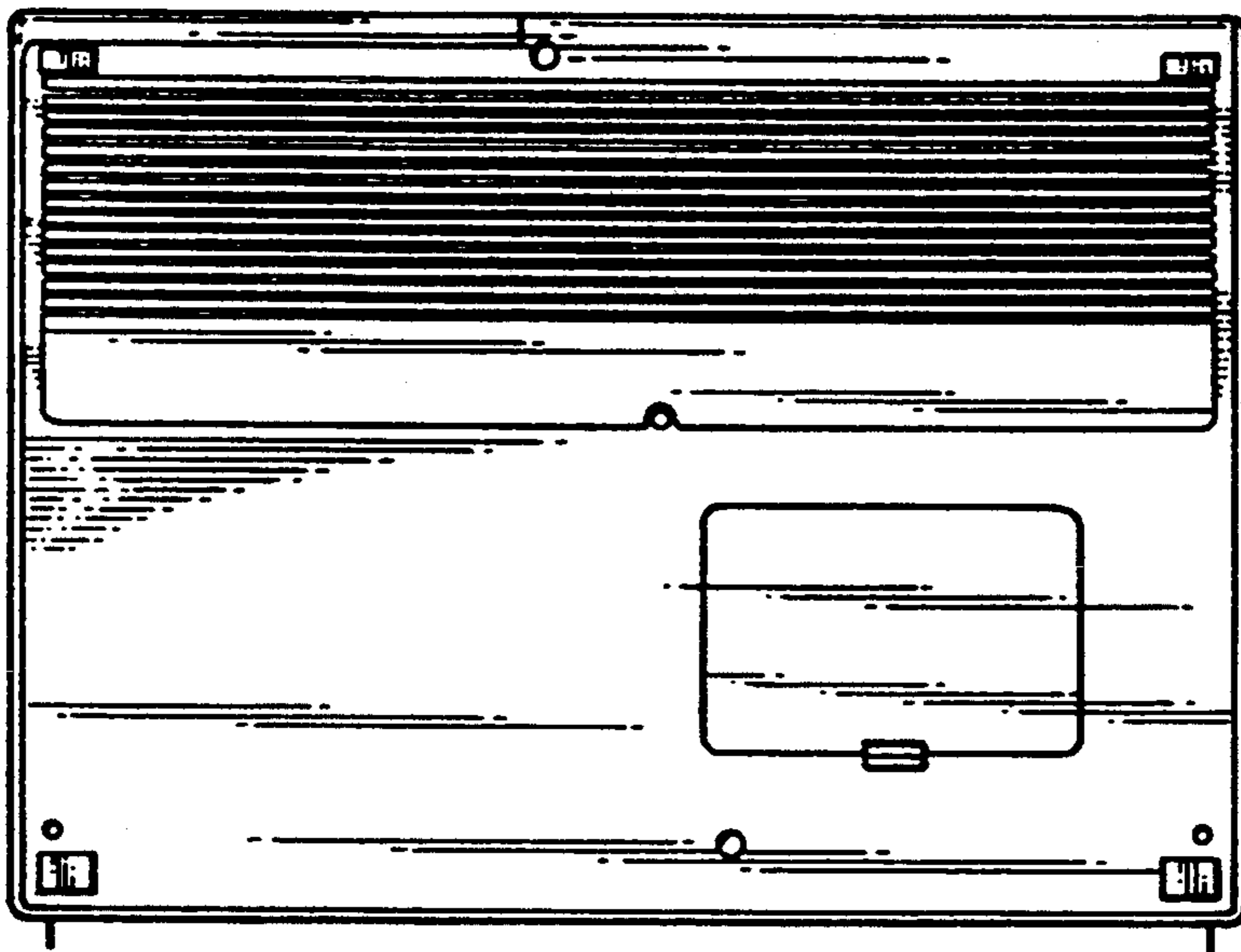

Fig. 5

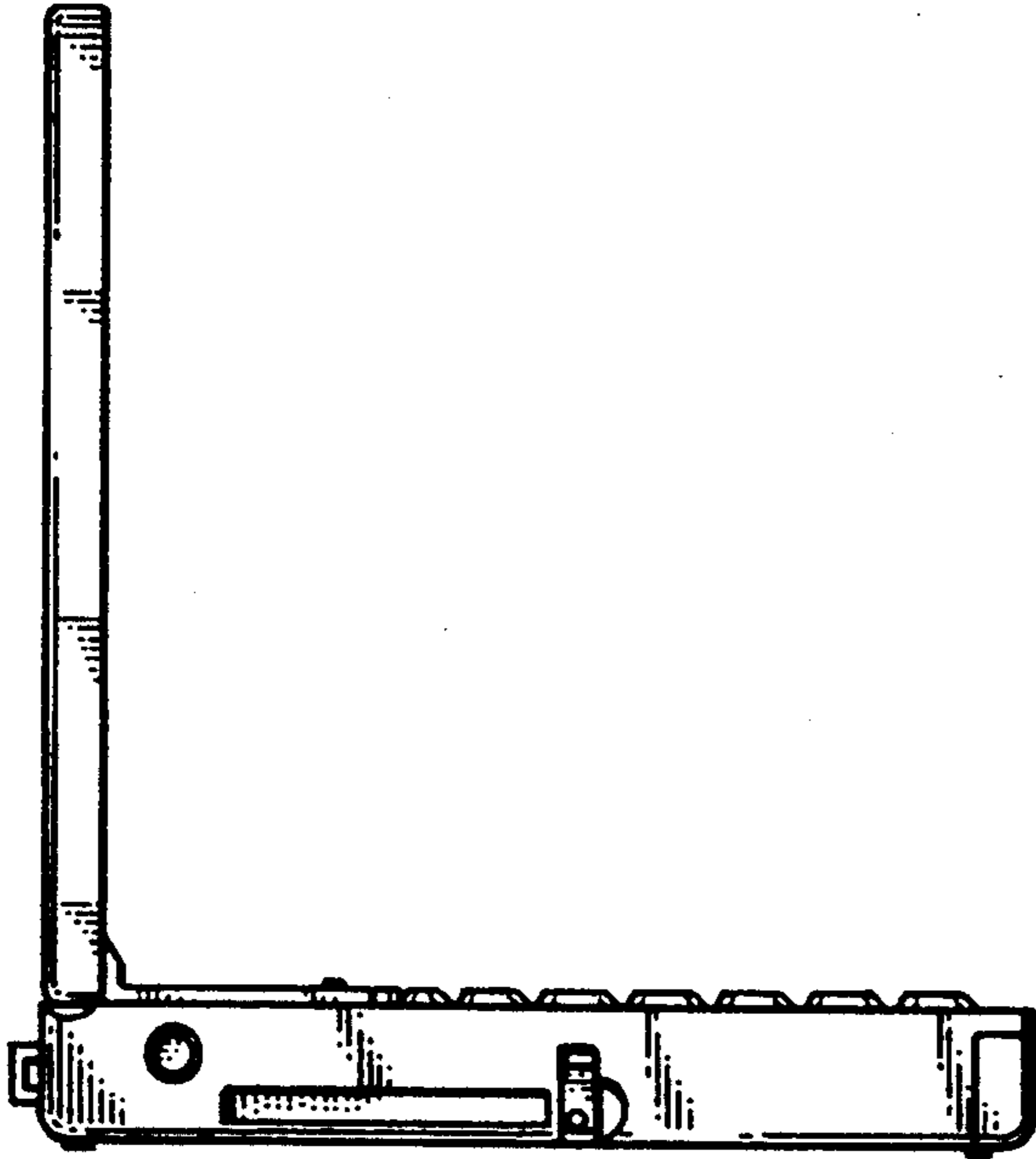

Fig. 6

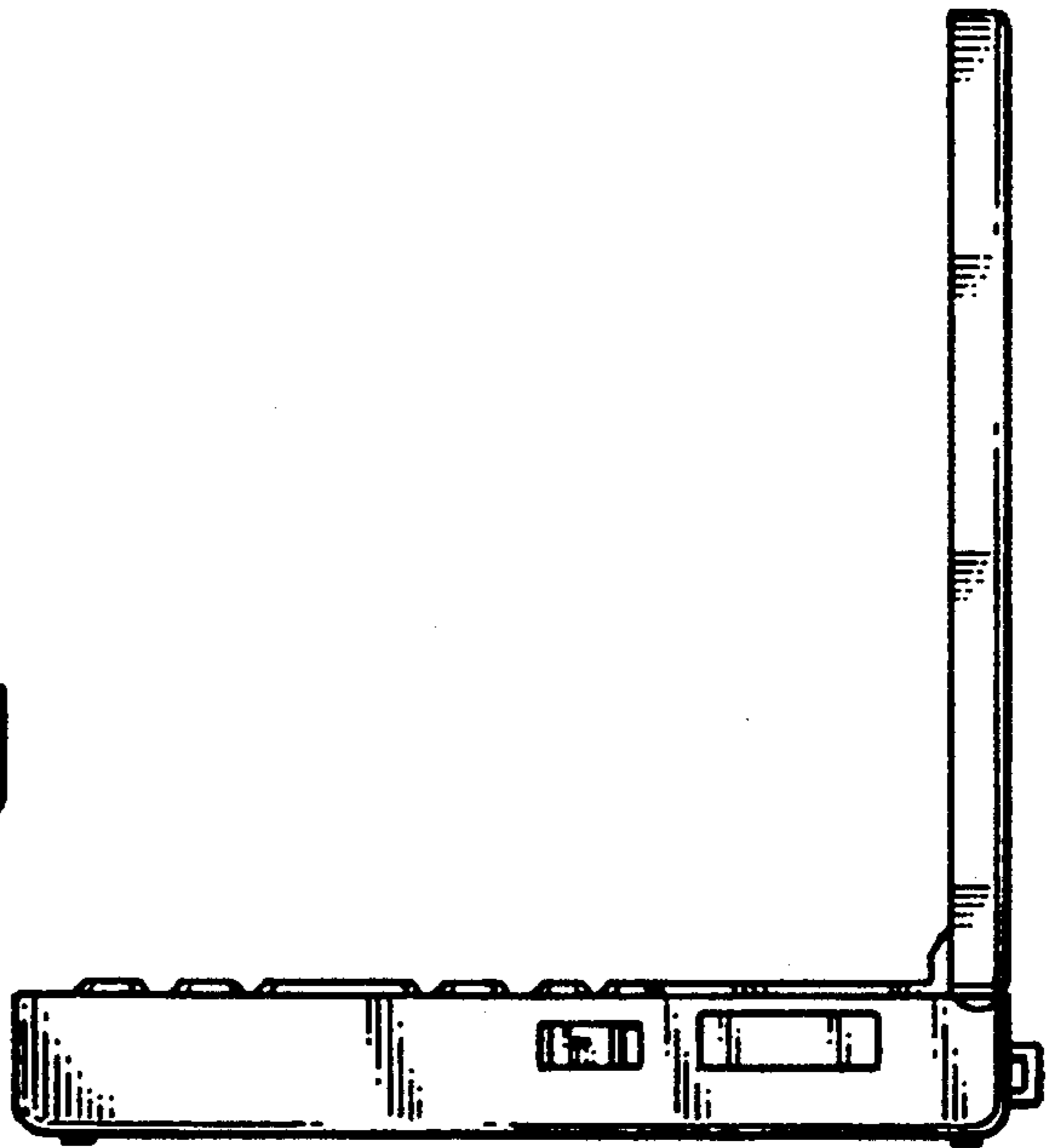

Fig. 7

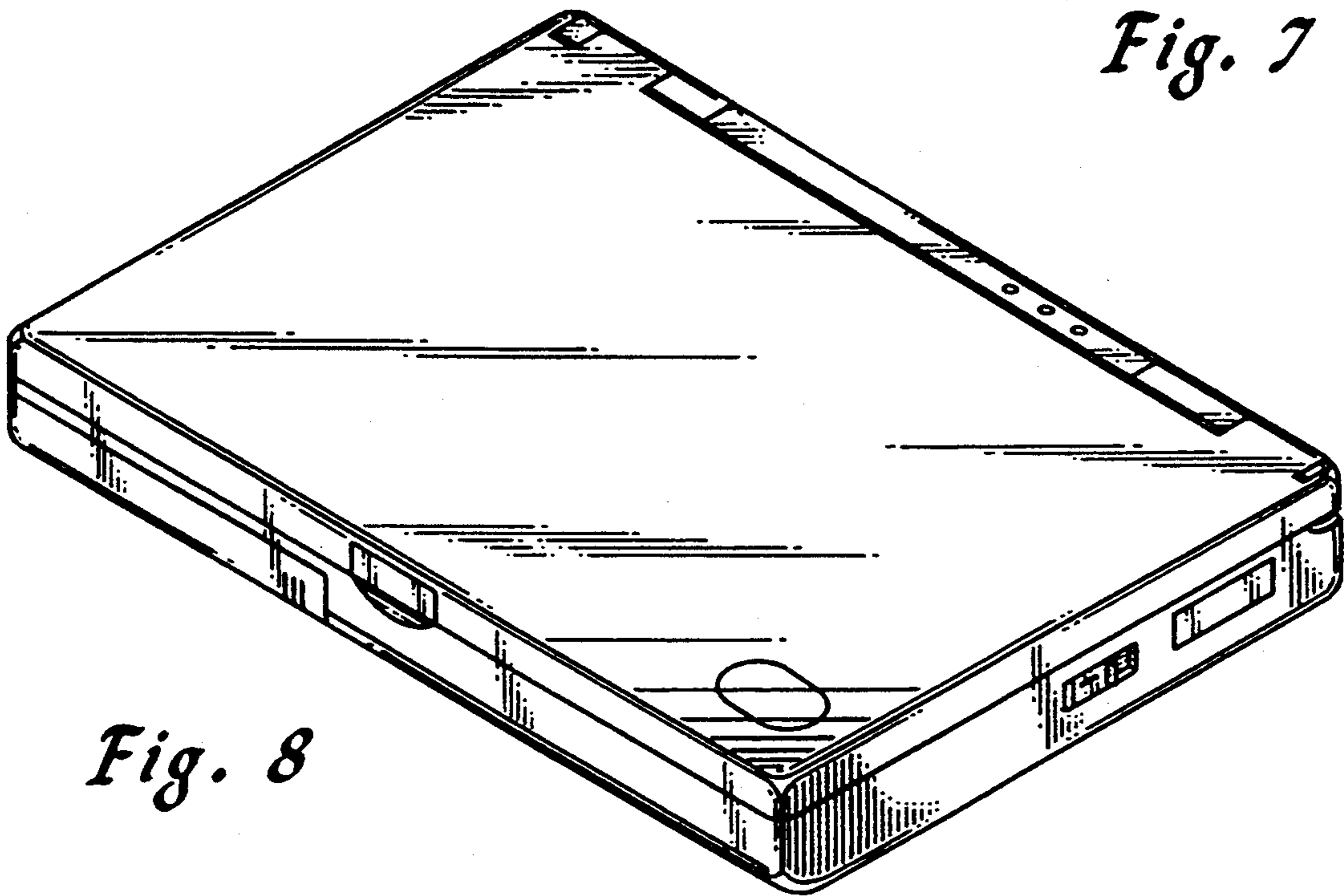

Fig. 8

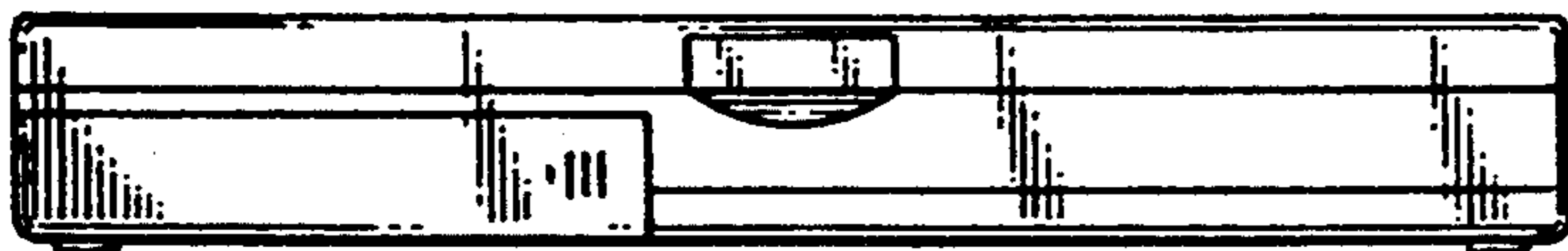

Fig. 9

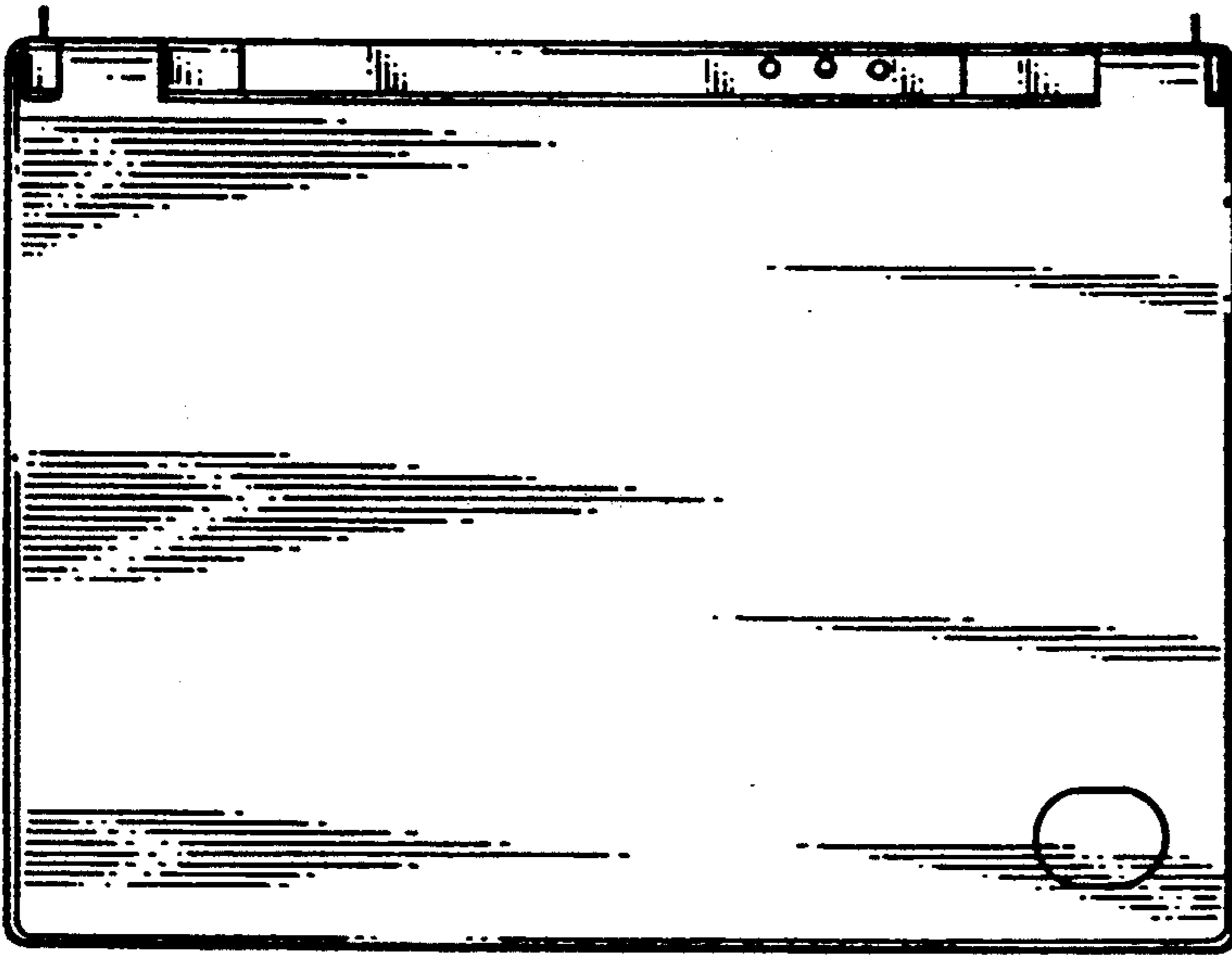

Fig. 11

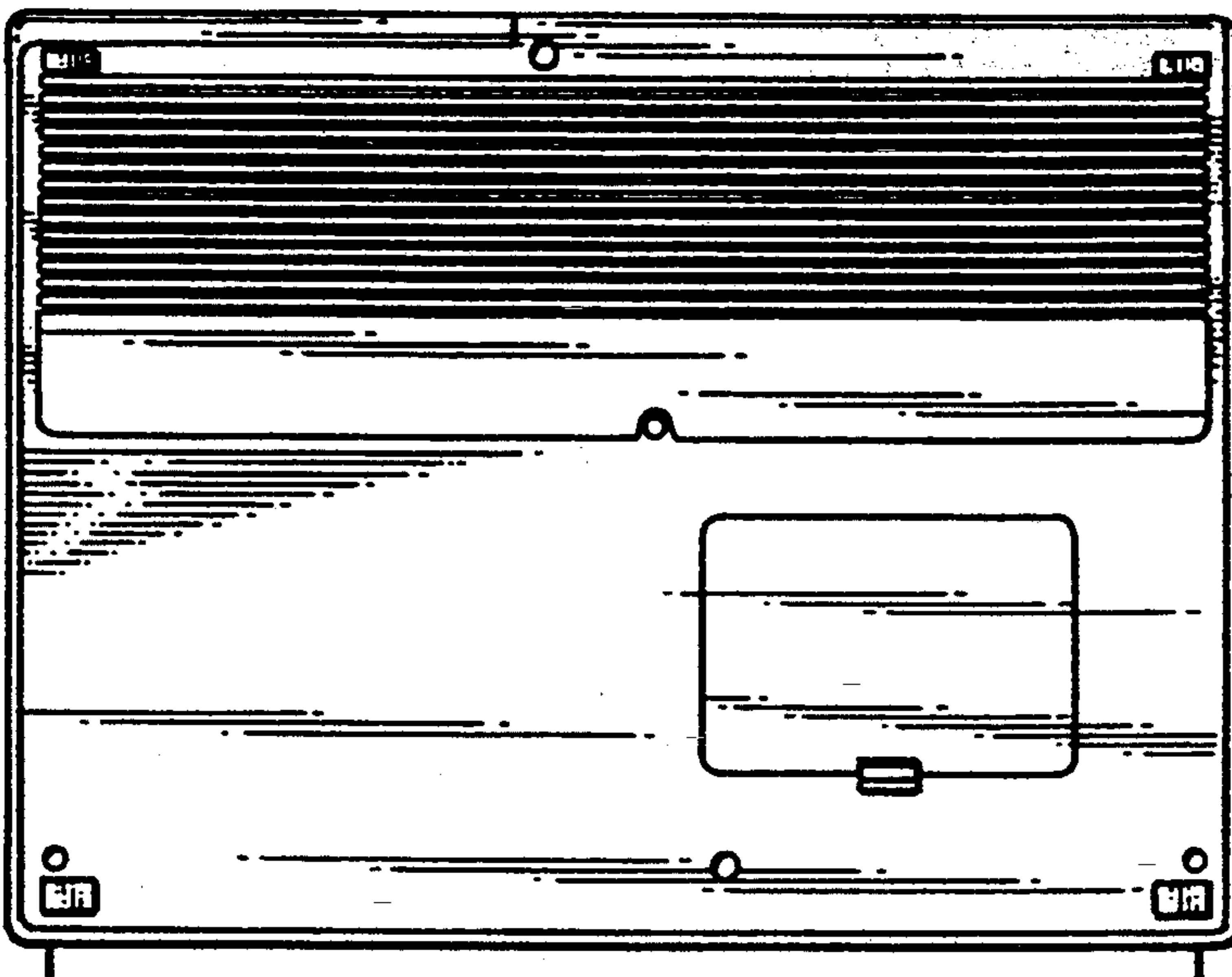

Fig. 12

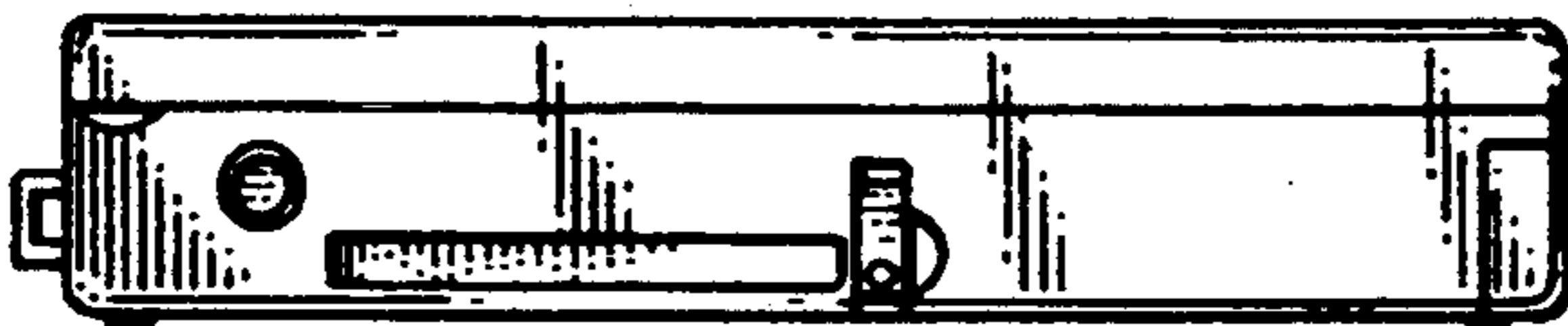

Fig. 13

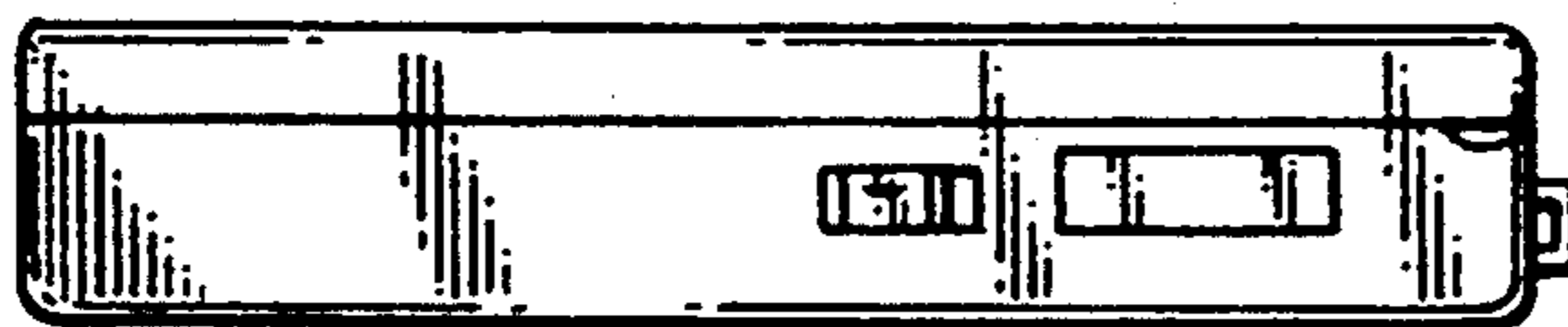

Fig. 14

UNITED STATES PATENT AND TRADEMARK OFFICE
CERTIFICATE OF CORRECTION

PATENT NO. : D-362,428
DATED : September 19, 1995
INVENTOR(S) : Kazuo Nakada

It is certified that error appears in the above-identified patent and that said Letters Patent is hereby corrected as shown below:

On the cover page, in the description of **Figure 8**, after "and" and before "side," please insert --right--.

Signed and Sealed this
Twelfth Day of March, 1996



BRUCE LEHMAN

Commissioner of Patents and Trademarks

Attest:

Attesting Officer