



US00D362341S

United States Patent [19]

[11] Patent Number: **Des. 362,341**

Sprague

[45] Date of Patent: **** Sep. 19, 1995**

[54] **COMBINED TOOTHBRUSH WITH COVER AND DENTAL FLOSS DISPENSER**

4,821,752 4/1989 Widlak 132/309
5,176,157 1/1993 Mazza 132/322

[76] Inventor: **Frances Sprague, 7751 E. Country Club Blvd., Boca Raton, Fla. 44387**

Primary Examiner—A. Hugo Word
Assistant Examiner—Lavone D. Tabor
Attorney, Agent, or Firm—M. K. Silverman

[**] Term: **14 Years**

[57] **CLAIM**

[21] Appl. No.: **829,335**

The ornamental design for a combined toothbrush with cover and dental floss dispenser, as shown and described.

[22] Filed: **Feb. 3, 1992**

[52] U.S. Cl. **D4/108; D28/64**

[58] Field of Search **D4/104-112, D4/116, 134, 138, 199; D28/64; 15/105, 159.1, 160, 167.1, 167.2, 184; 132/308-309, 311, 322-328**

DESCRIPTION

[56] **References Cited**

U.S. PATENT DOCUMENTS

D. 136,566 10/1943 Watt D4/108
D. 156,134 11/1949 Lodewick et al. D4/108
3,927,687 12/1975 Thierman 132/325

FIG. 1 is a perspective view of the inventive combined toothbrush with cover and dental floss dispenser;
FIG. 2 is a top view thereof;
FIG. 3 is a bottom view thereof;
FIG. 4 is a left end view thereof;
FIG. 5 is a right end view thereof;
FIG. 6 is a rear view of the system; and,
FIG. 7 is a front view thereof.

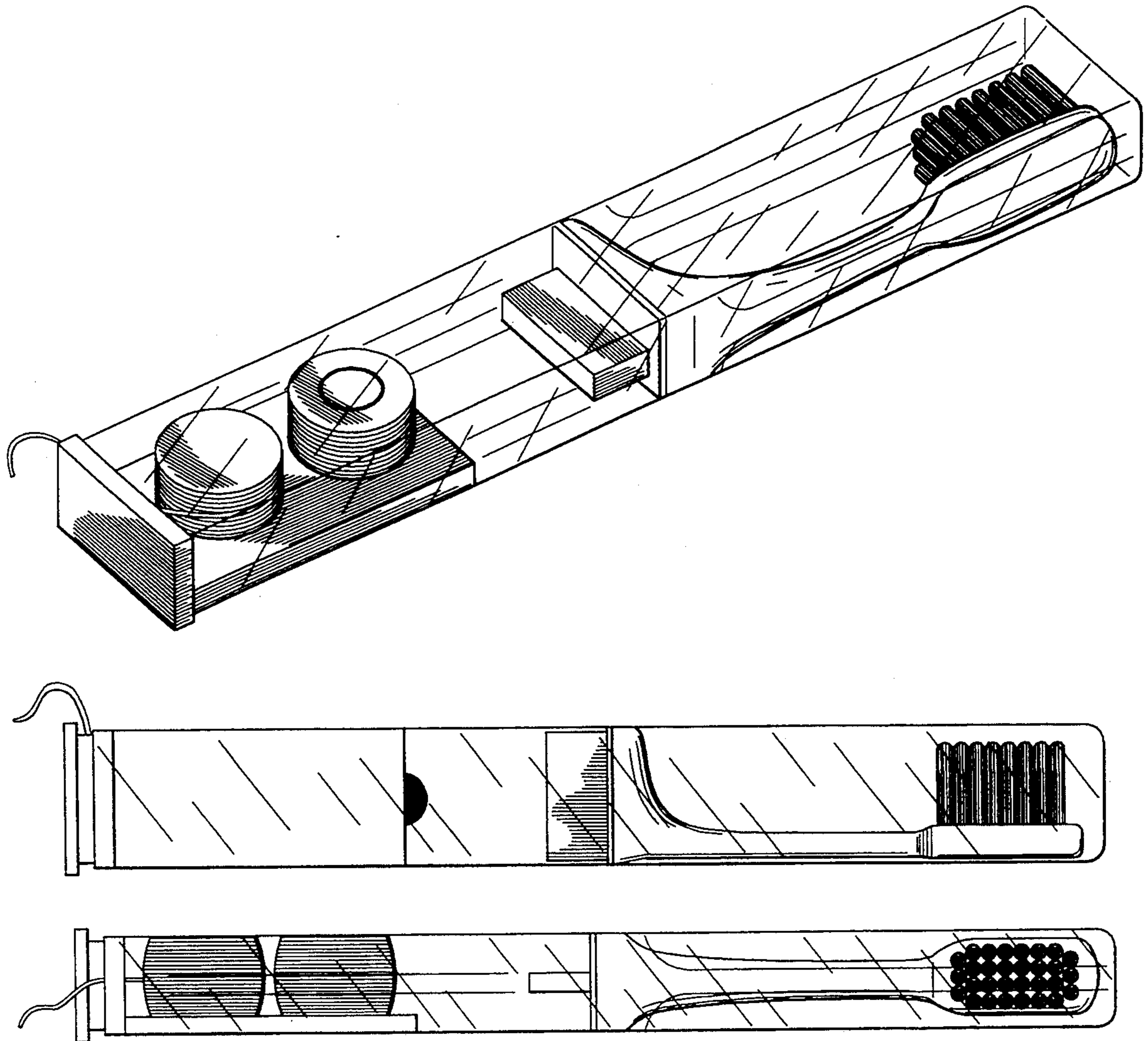

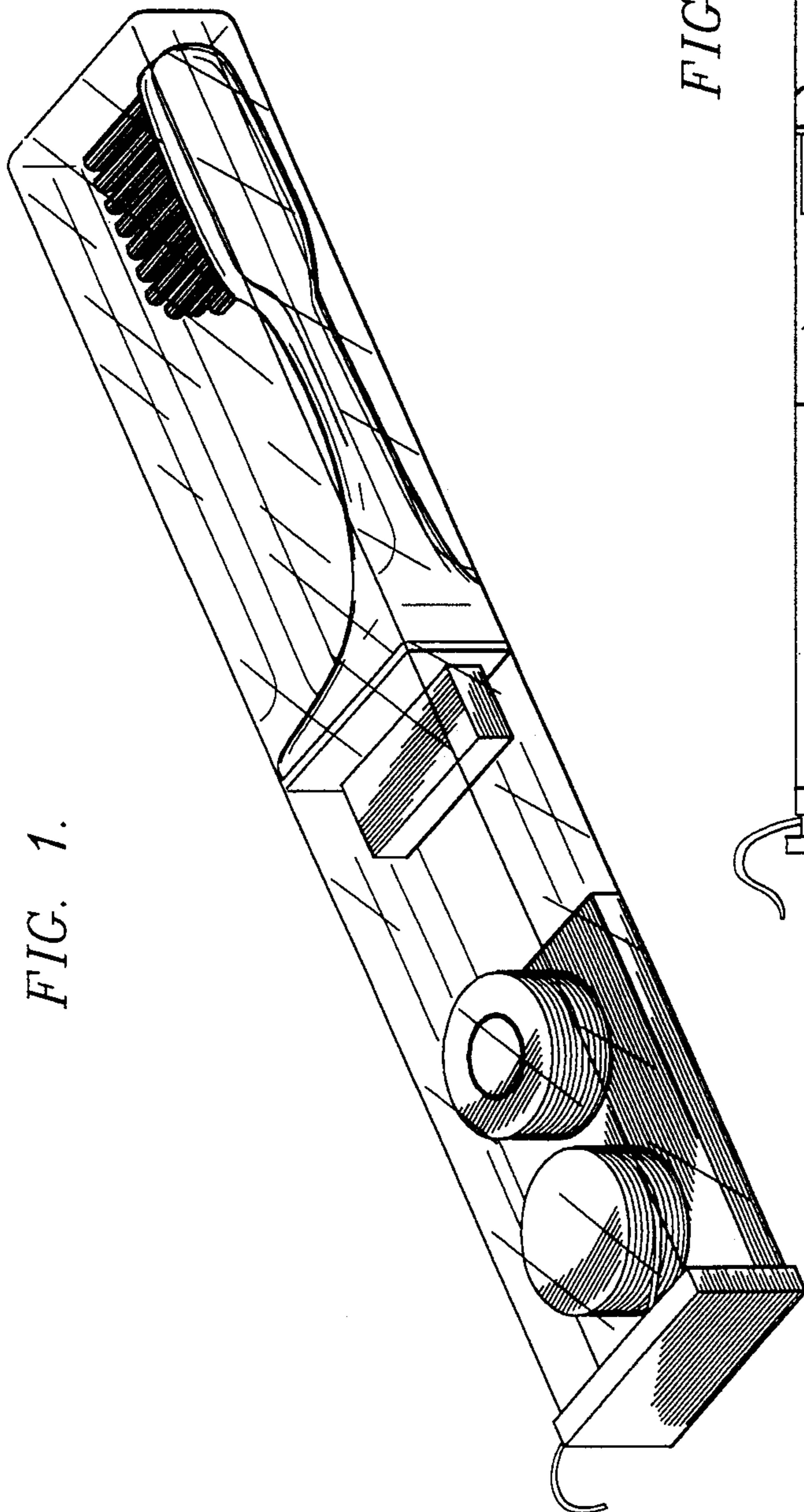

FIG. 1.

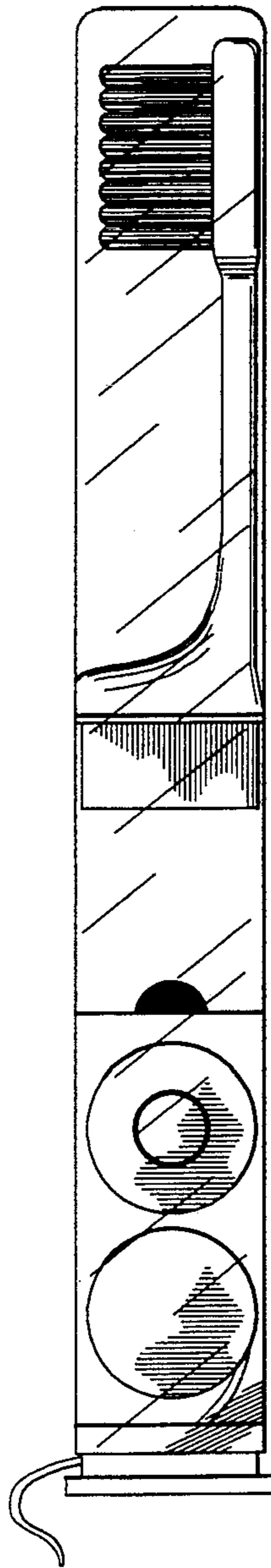

FIG. 2.

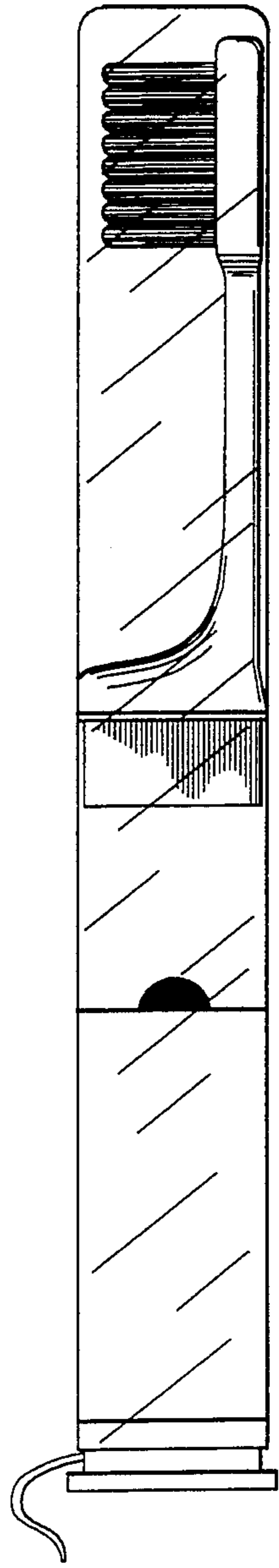

FIG. 3.

FIG. 4.

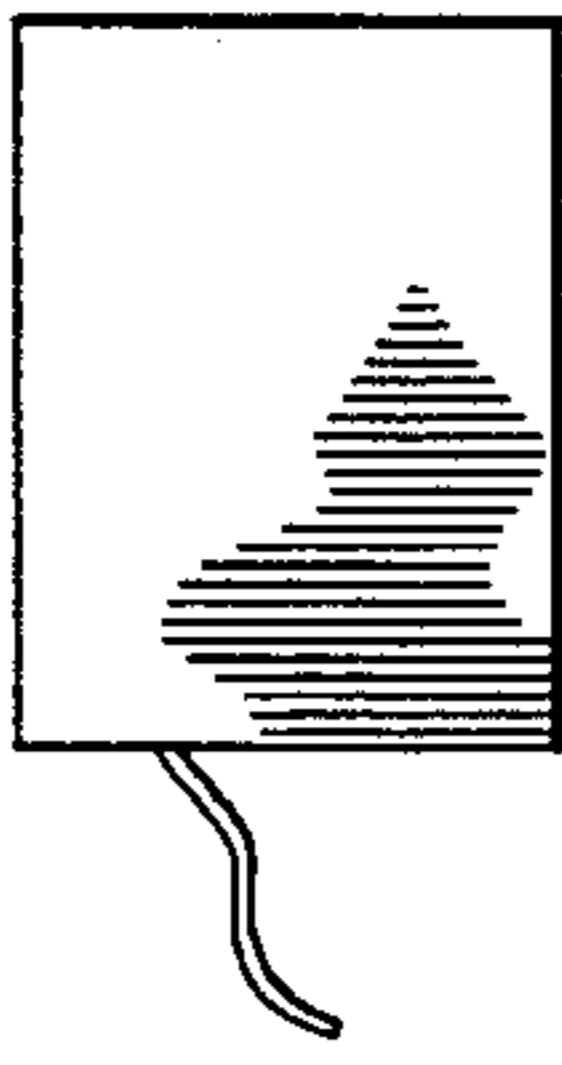

FIG. 5.

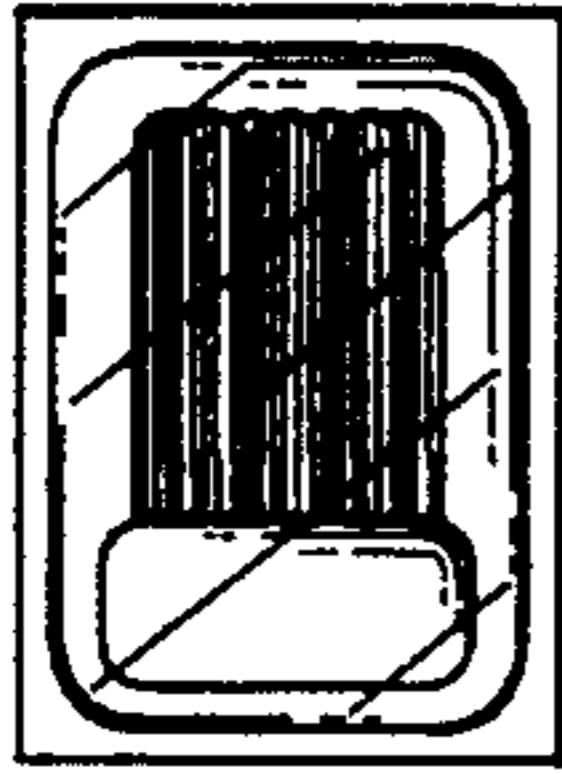

FIG. 6.

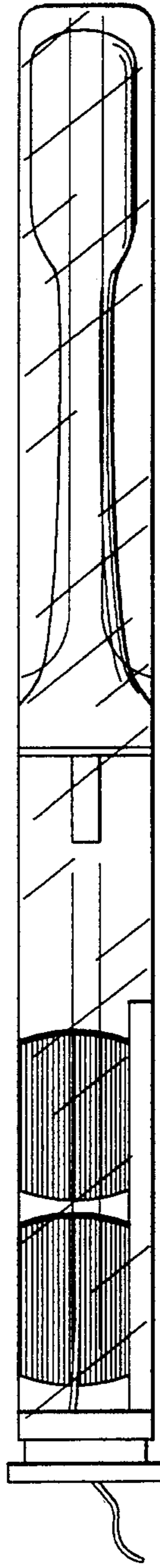

FIG. 7.

