



US00D362310S

# United States Patent [19]

[11] Patent Number: **Des. 362,310**

Fleming et al.

[45] Date of Patent: **\*\* Sep. 12, 1995**

[54] **GLASS BLOCK**

D. 311,975 11/1990 Hackelsberger ..... D25/103  
3,017,724 1/1962 Frank ..... 52/306

[75] Inventors: **Harry A. Fleming**, Smethport; **Ralph J. Harrison**, Roulette, both of Pa.; **Donald E. Hock**, Olean, N.Y.

*Primary Examiner*—Doris Clark  
*Attorney, Agent, or Firm*—Reed Smith Shaw & McClay

[73] Assignee: **Pittsburgh Corning Corporation**, Pittsburgh, Pa.

### [57] CLAIM

An ornamental design for a glass block, as shown.

[\*\*] Term: **14 Years**

### DESCRIPTION

[21] Appl. No.: **21,057**

FIG. 1 is a front view of the glass block;  
FIG. 2 is a left side view of the glass block;  
FIG. 3 is a right side view of the glass block;  
FIG. 4 is a top plan view of the glass block; and  
FIG. 5 is a bottom plan view of the glass block;  
FIG. 6 is a front cross-sectional view of the glass block taken along lines VI—VI of FIG. 3 illustrating undulations upon the inner surface of the glass block, giving the glass block an undulating appearance; and,  
FIG. 7 is a right side cross-sectional view of the glass block taken along lines VII—VII of FIG. 1 illustrating undulations upon the inner surface of the glass block, giving the glass block an undulating appearance.

[22] Filed: **Apr. 8, 1994**

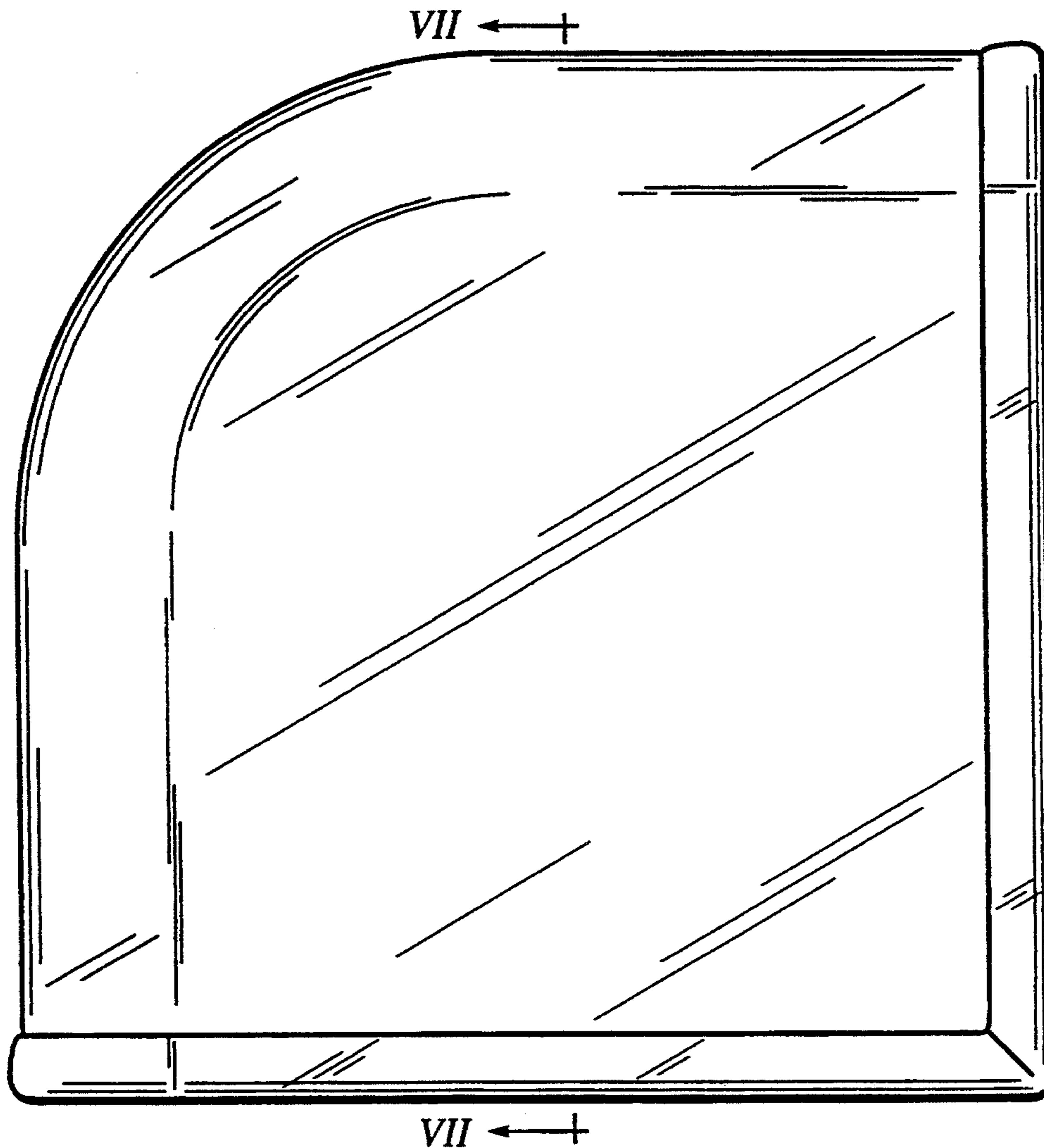
[52] U.S. Cl. .... **D25/103**

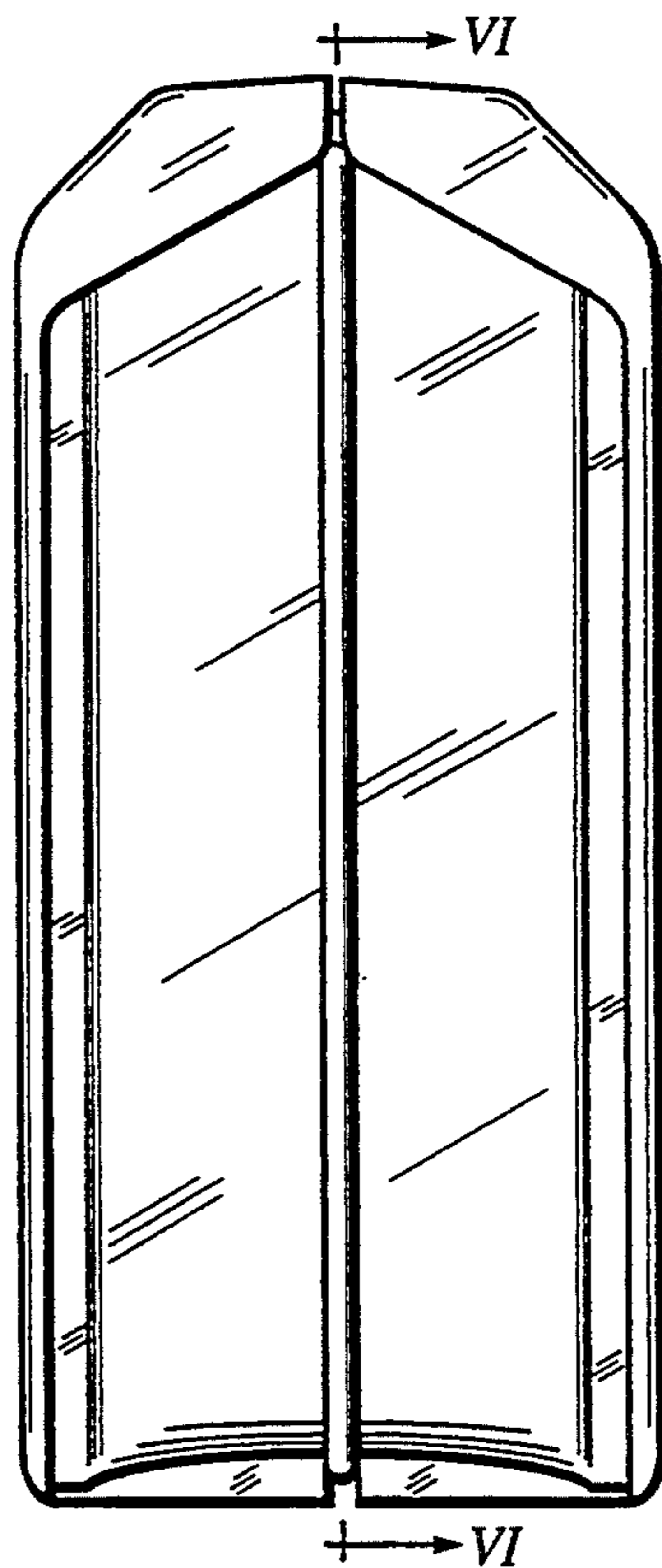
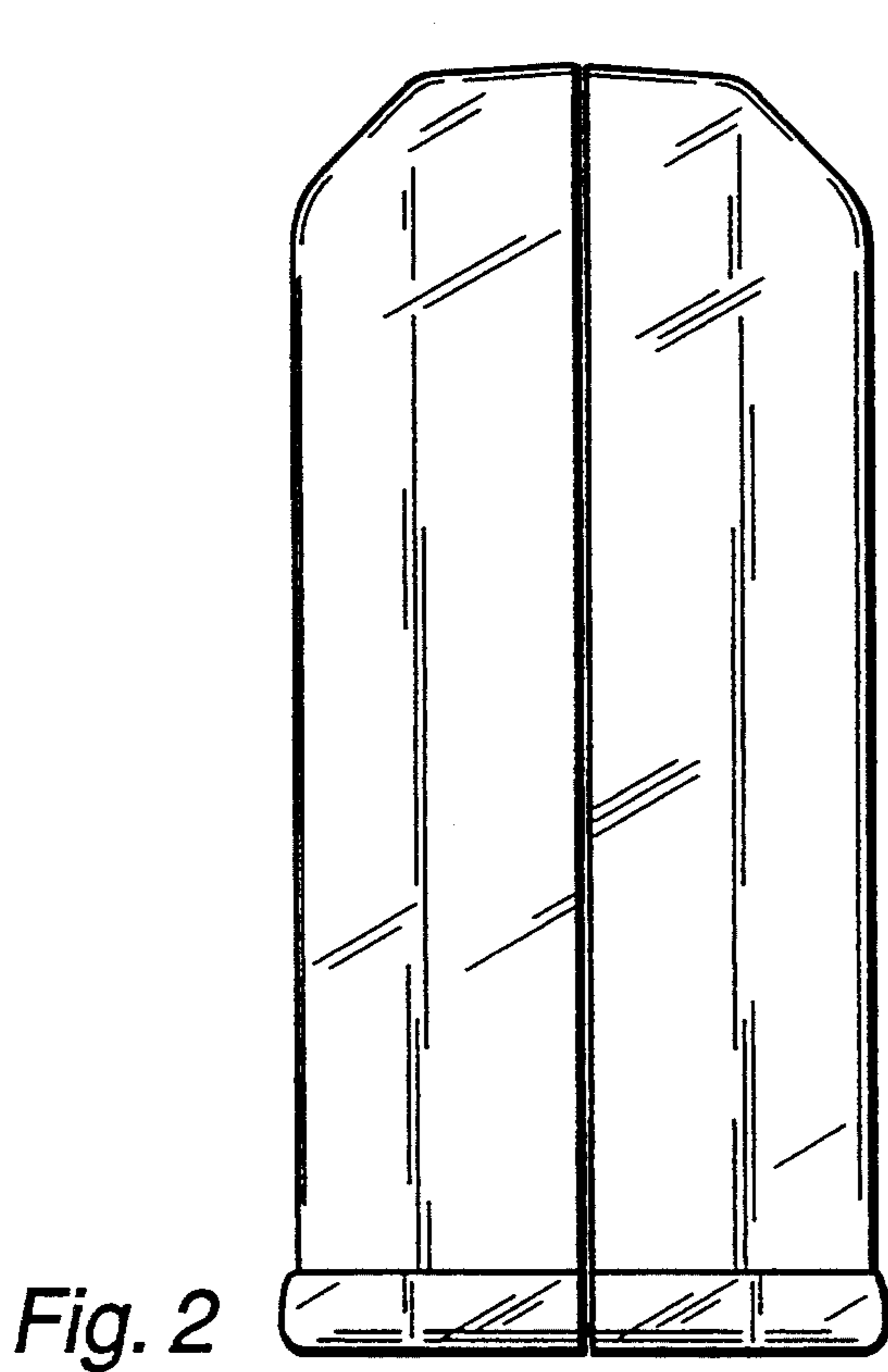
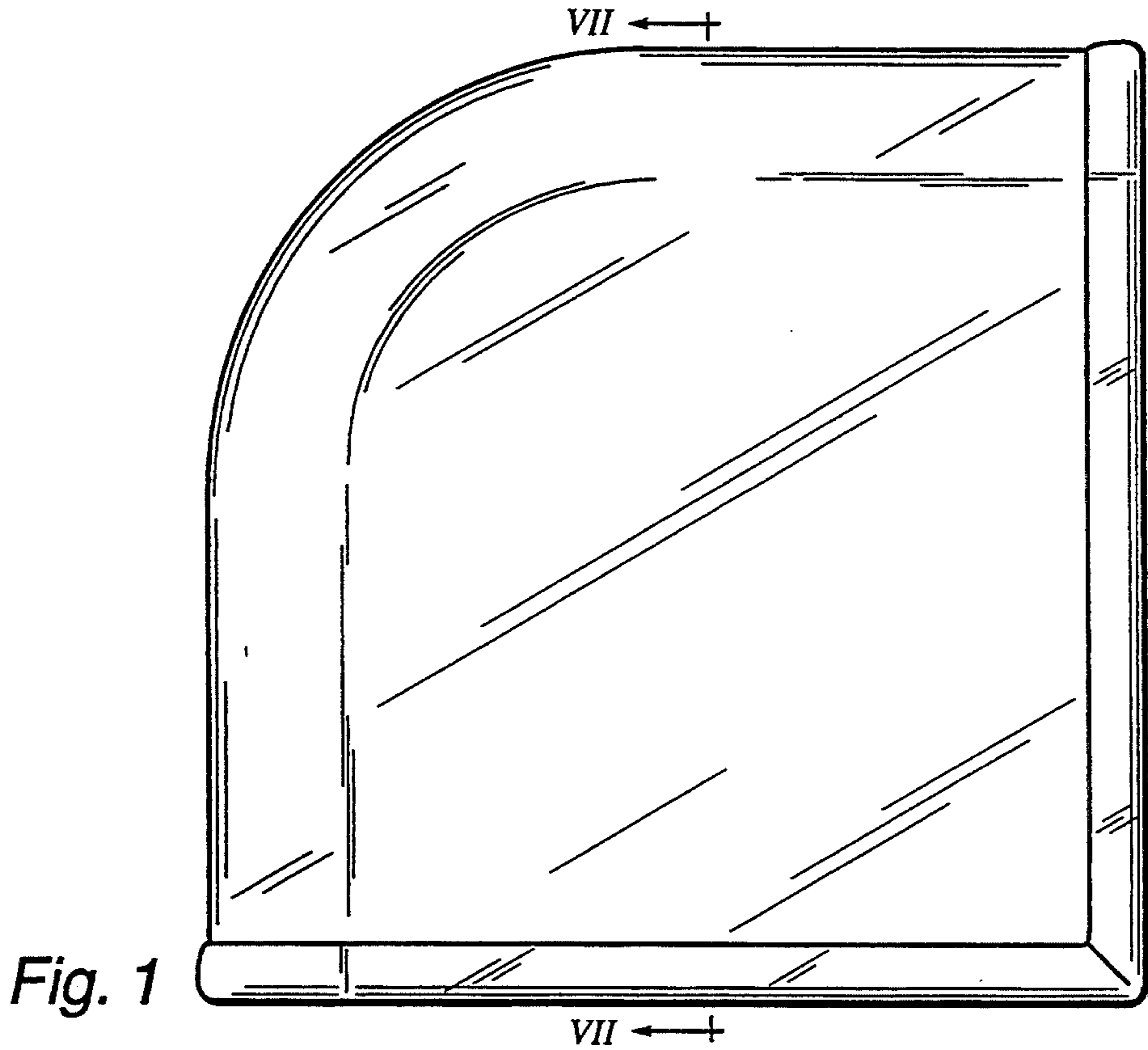
[58] Field of Search ..... D25/103-118;  
52/306, 308

### [56] References Cited

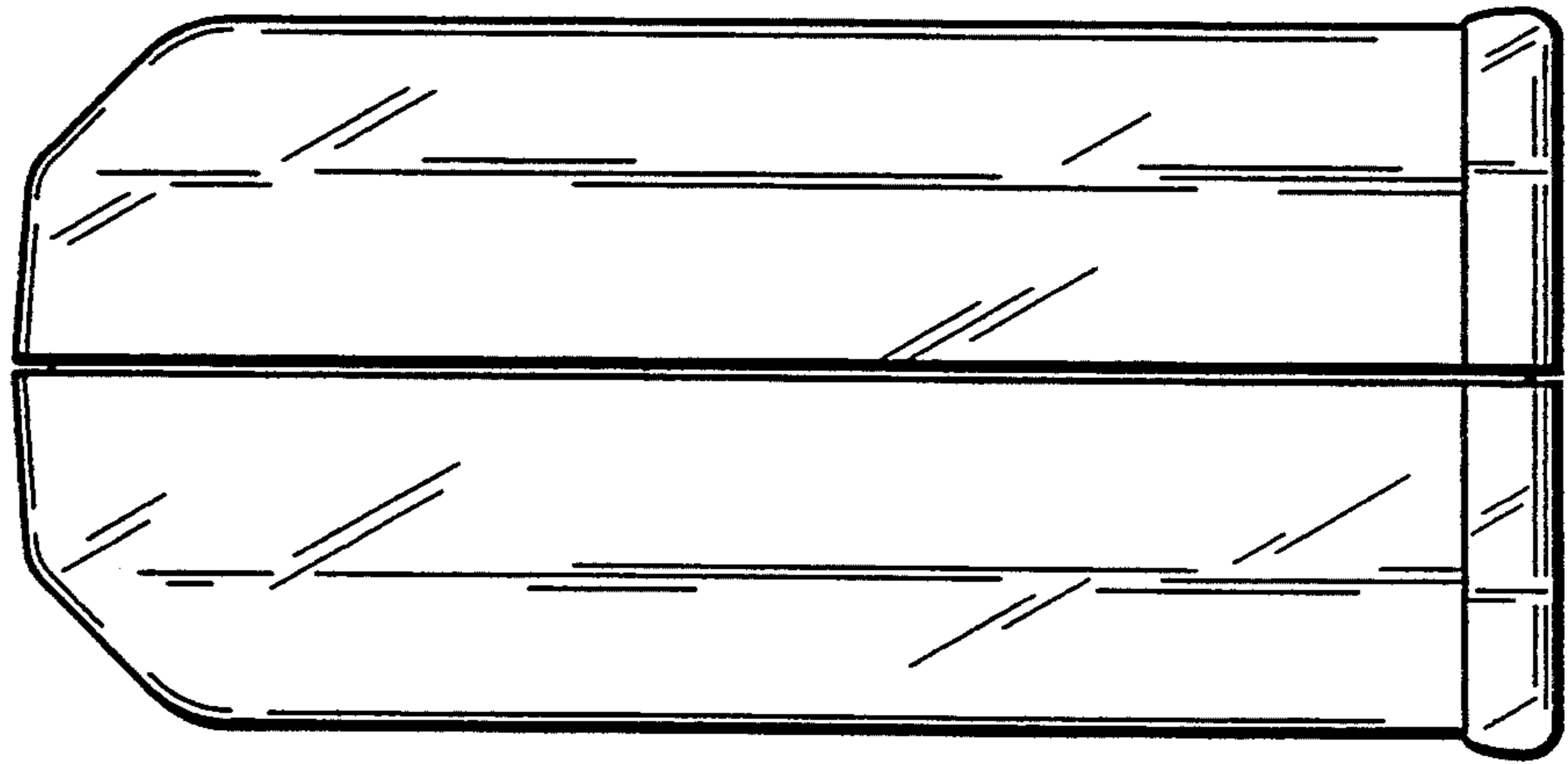
#### U.S. PATENT DOCUMENTS

D. 31,329 8/1899 McNeill ..... D25/113  
D. 109,025 3/1938 Perkins ..... D25/108  
D. 300,061 2/1989 Hackelsberger ..... D25/107

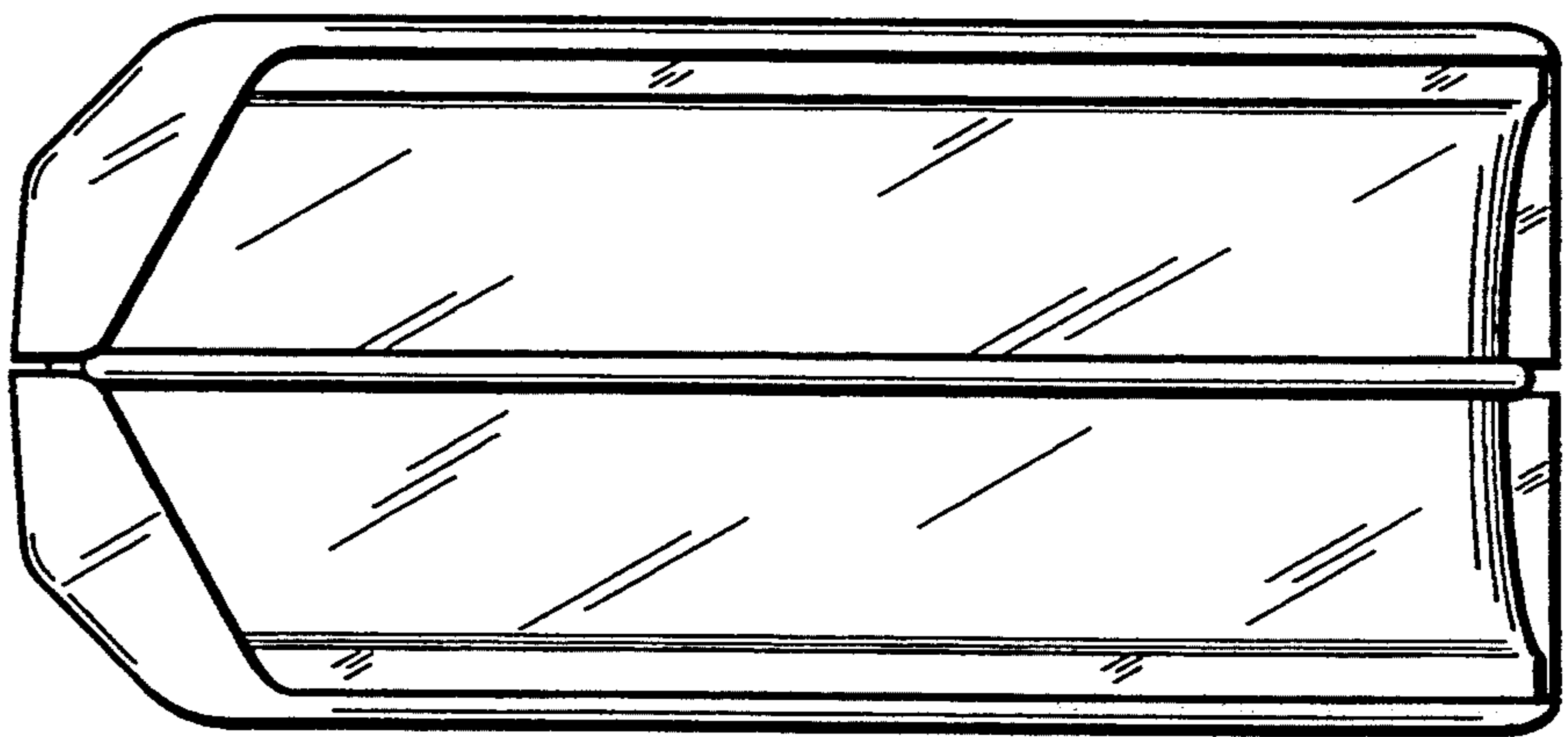




*Fig. 4*



*Fig. 5*



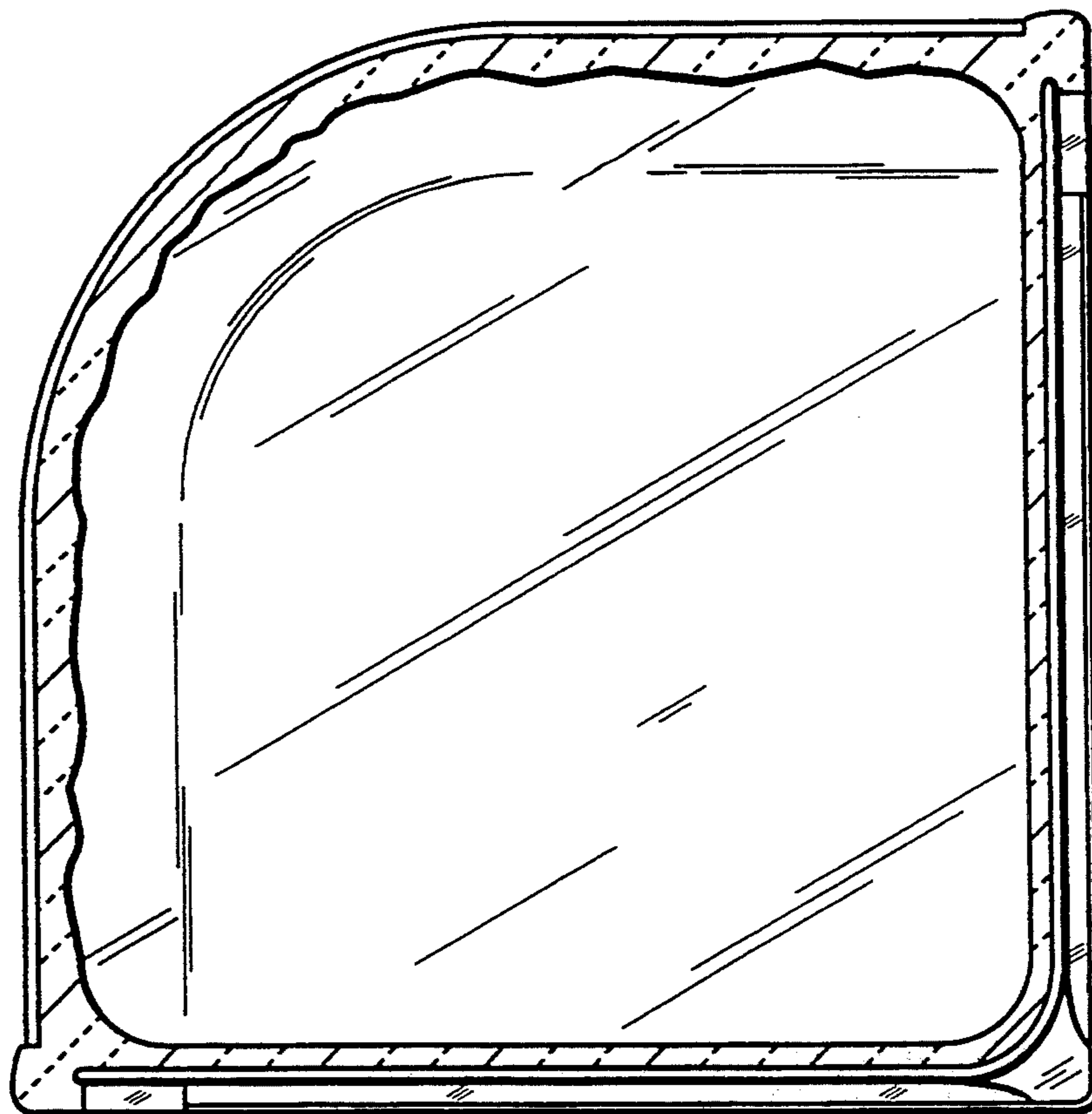


Fig. 6

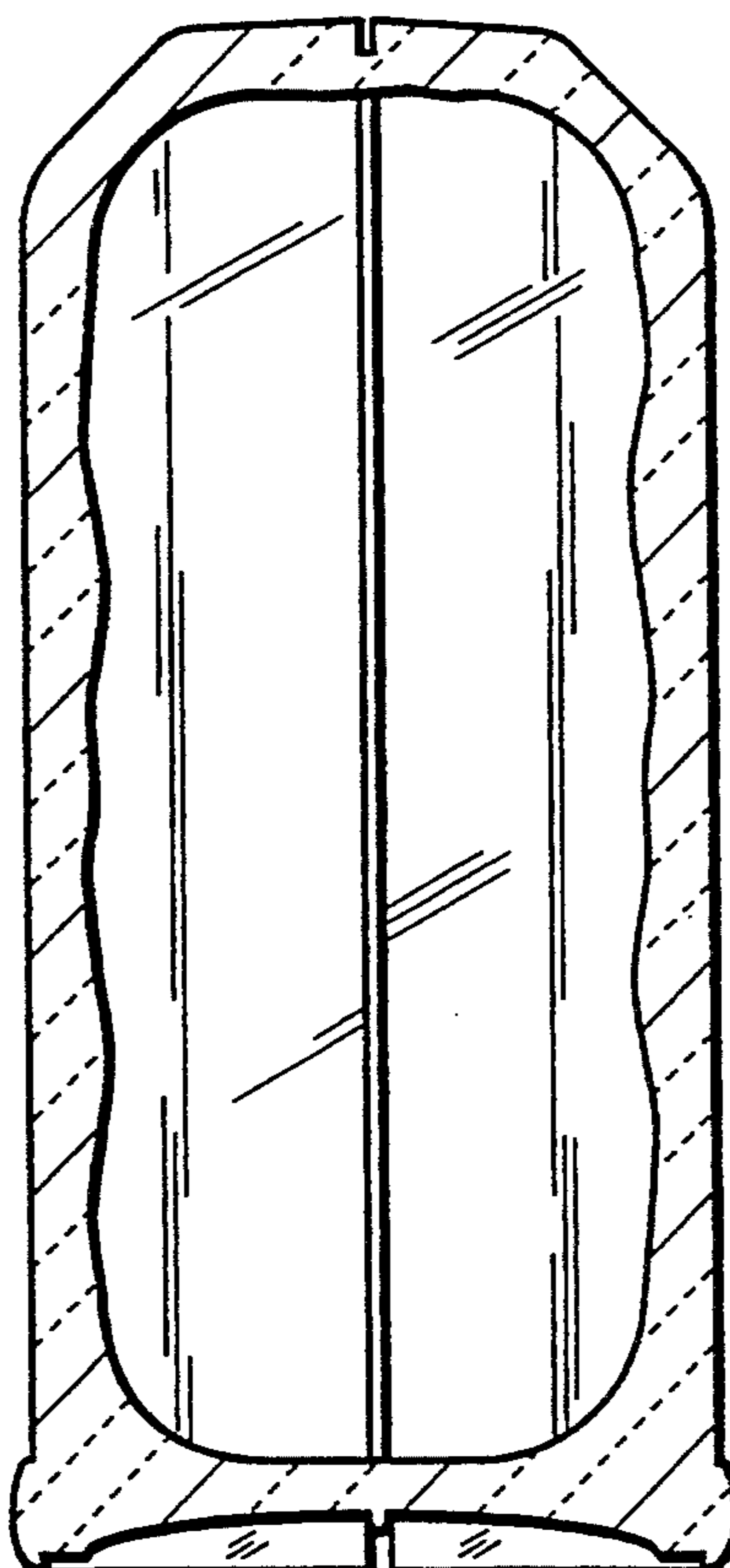


Fig. 7