



US00D362269S

United States Patent [19]

[11] Patent Number: **Des. 362,269**

Hollington

[45] Date of Patent: **** Sep. 12, 1995**

[54] WRITING INSTRUMENT

DESCRIPTION

- [75] Inventor: **Geoffrey A. Hollington**, London, England
- [73] Assignee: **Parker Pen (I.P) Limited**, Isleworth, United Kingdom
- [**] Term: **14 Years**
- [21] Appl. No.: **18,794**
- [22] Filed: **Feb. 15, 1994**

[30] Foreign Application Priority Data

- Aug. 17, 1993 [GB] United Kingdom 2033205
- Aug. 17, 1993 [GB] United Kingdom 2033206
- Aug. 17, 1993 [GB] United Kingdom 2033207
- Aug. 17, 1993 [GB] United Kingdom 2033208
- [52] U.S. Cl. **D19/51; D19/50; D19/56; D19/57**
- [58] Field of Search **D19/35, 36, 41-51, D19/54-58, 75, 81-85; 401/221, 243, 244, 245, 246, 247**

[56] References Cited

U.S. PATENT DOCUMENTS

- D. 88,821 12/1932 Platt et al. D19/56
- D. 143,176 12/1945 Whitehouse D19/51
- D. 150,320 7/1948 Starr D19/51
- D. 223,130 3/1972 Green D19/75 X
- D. 312,477 12/1990 Porsche D19/43
- D. 330,217 10/1992 Booker D19/48
- D. 331,261 11/1992 Bannwart D19/48 X
- D. 338,491 8/1993 Hollington D19/50

Primary Examiner—Martie Thompson
Attorney, Agent, or Firm—Paul I. Douglas

[57] CLAIM

The ornamental design for a writing instrument, as shown and described.

FIG. 1 is a left side elevational view of a writing instrument showing my new design;
 FIG. 2 is a front elevational view;
 FIG. 3 is a top plan view;
 FIG. 4 is a bottom plan view;
 FIG. 5 is a rear elevational view with the cap member removed for convenience of illustration;
 FIG. 6 is a left side elevational view thereof of FIG. 5;
 FIG. 7 is a front elevational view of FIG. 5;
 FIG. 8 is a perspective view in an exploded condition of a second embodiment of my new design;
 FIG. 9 is a right side elevational view of FIG. 8;
 FIG. 10 is a front elevational view of FIG. 8;
 FIG. 11 is a left side elevational view of FIG. 8;
 FIG. 12 is a top plan view of FIG. 8;
 FIG. 13 is a bottom plan view of FIG. 8;
 FIG. 14 is a front elevational view of FIG. 8 with the cap member removed for convenience of illustration;
 FIG. 15 is a left side elevational view of FIG. 14;
 FIG. 16 is a rear elevational view of FIG. 14;
 FIG. 17 is a top plan view of FIG. 14;
 FIG. 18 is a left side elevational view of a third embodiment of my new design;
 FIG. 19 is a front elevational view of FIG. 18;
 FIG. 20 is a top plan view of FIG. 18;
 FIG. 21 is a bottom plan view of FIG. 18;
 FIG. 22 is a rear elevational view of FIG. 18 with the cap member removed for convenience of illustration;
 FIG. 23 is a left side elevational view of FIG. 22;
 FIG. 24 is a front elevational view of FIG. 22;
 FIG. 25 is a perspective view in an exploded condition of a fourth embodiment of my new design;
 FIG. 26 is a right side elevational view of FIG. 25;
 FIG. 27 is a front elevational view of FIG. 25;
 FIG. 28 is a left side elevational view of FIG. 25;
 FIG. 29 is a top plan view of FIG. 25;
 FIG. 30 is a bottom plan view of FIG. 25;
 FIG. 31 is a front elevational view of FIG. 25 with the cap member removed for convenience of illustration;
 FIG. 32 is a left side elevational view of FIG. 31;
 FIG. 33 is a rear elevational view of FIG. 31; and,
 FIG. 34 is a top plan view of FIG. 31.

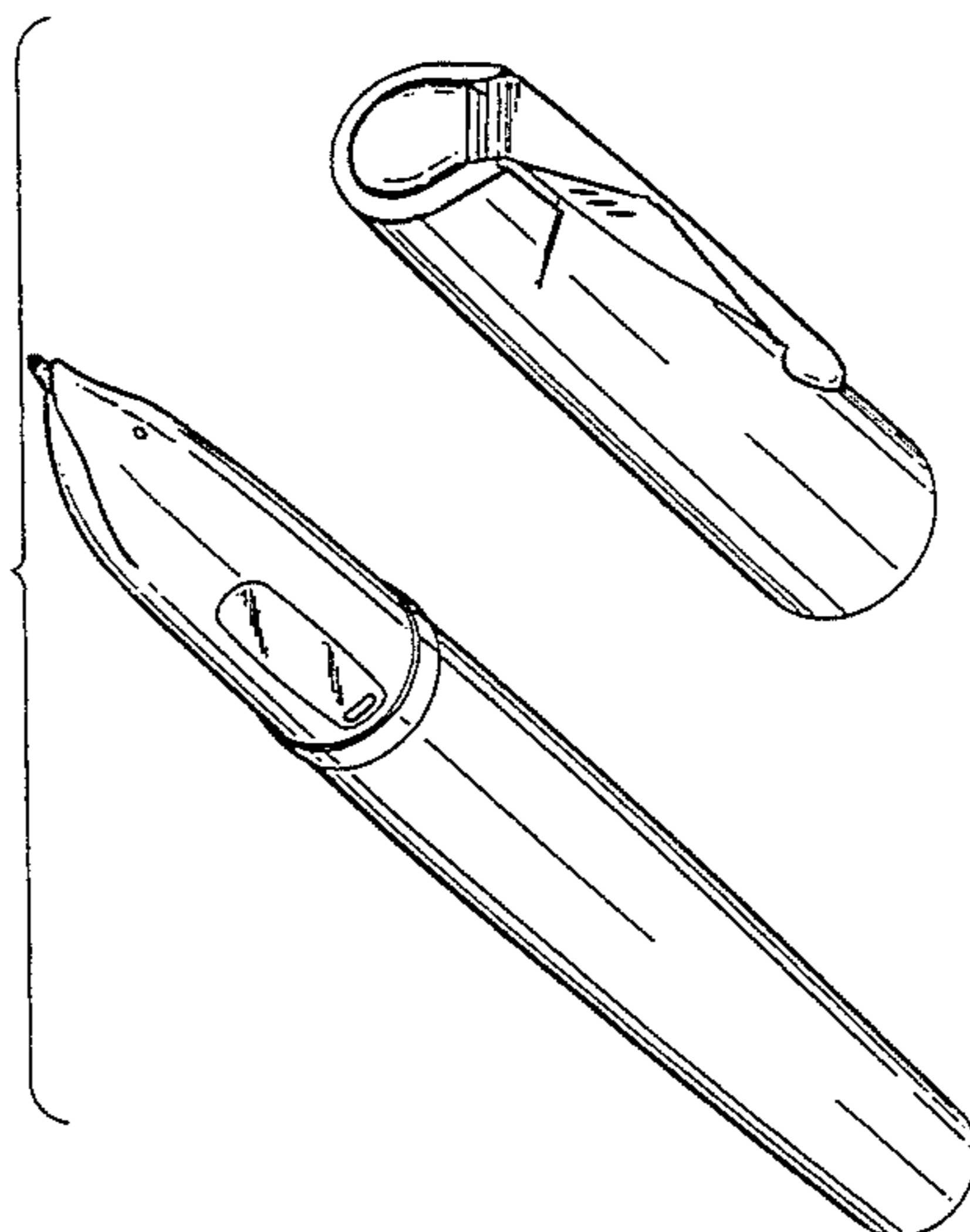

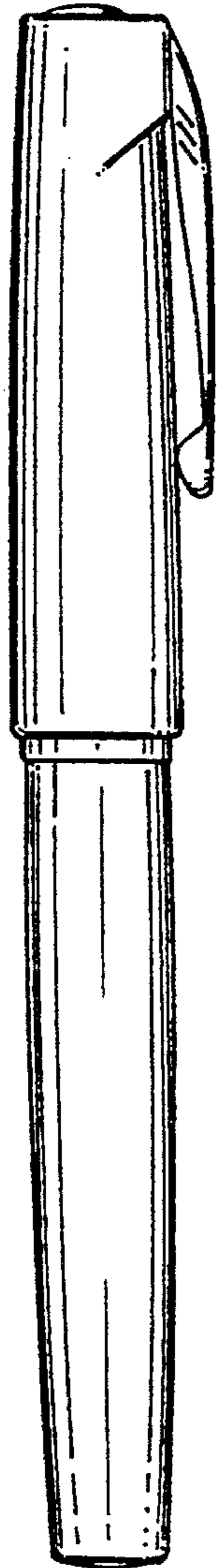

FIG. 1

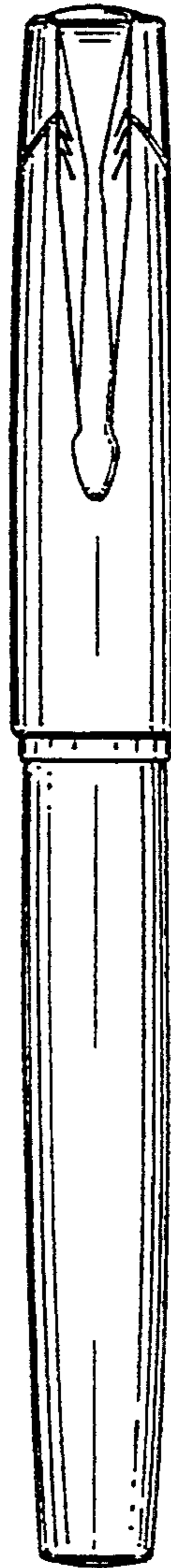

FIG. 2

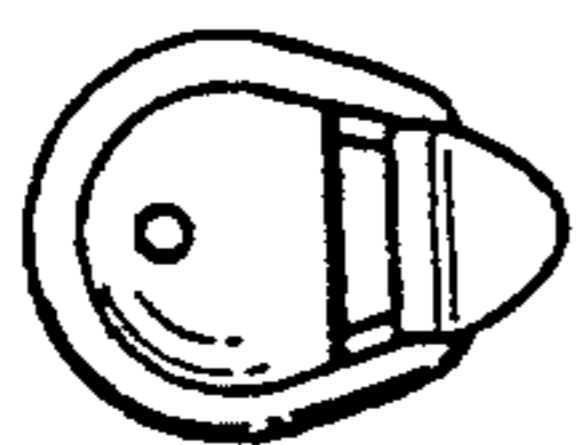

FIG. 3



FIG. 4

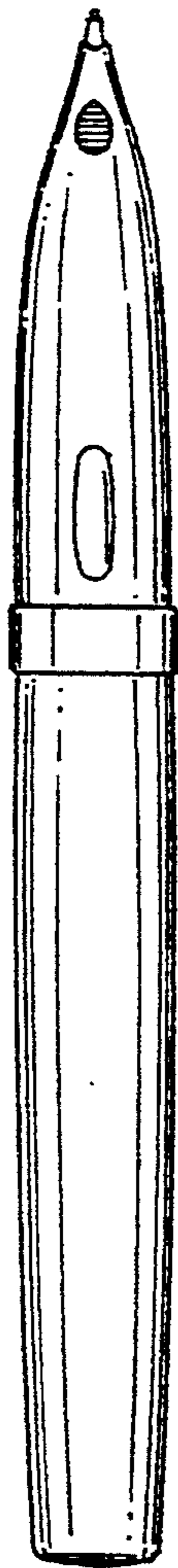

FIG. 5

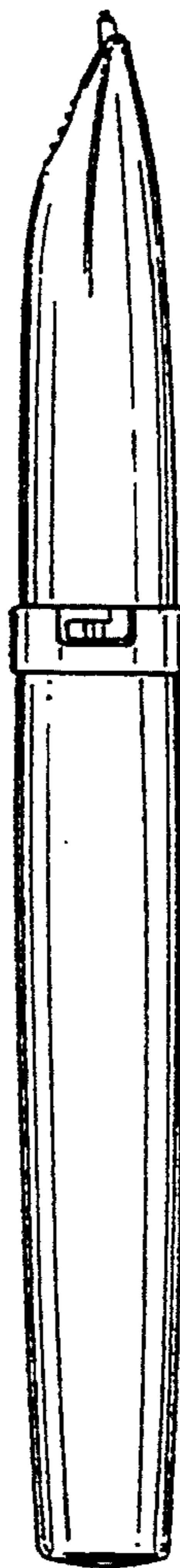

FIG. 6



FIG. 7

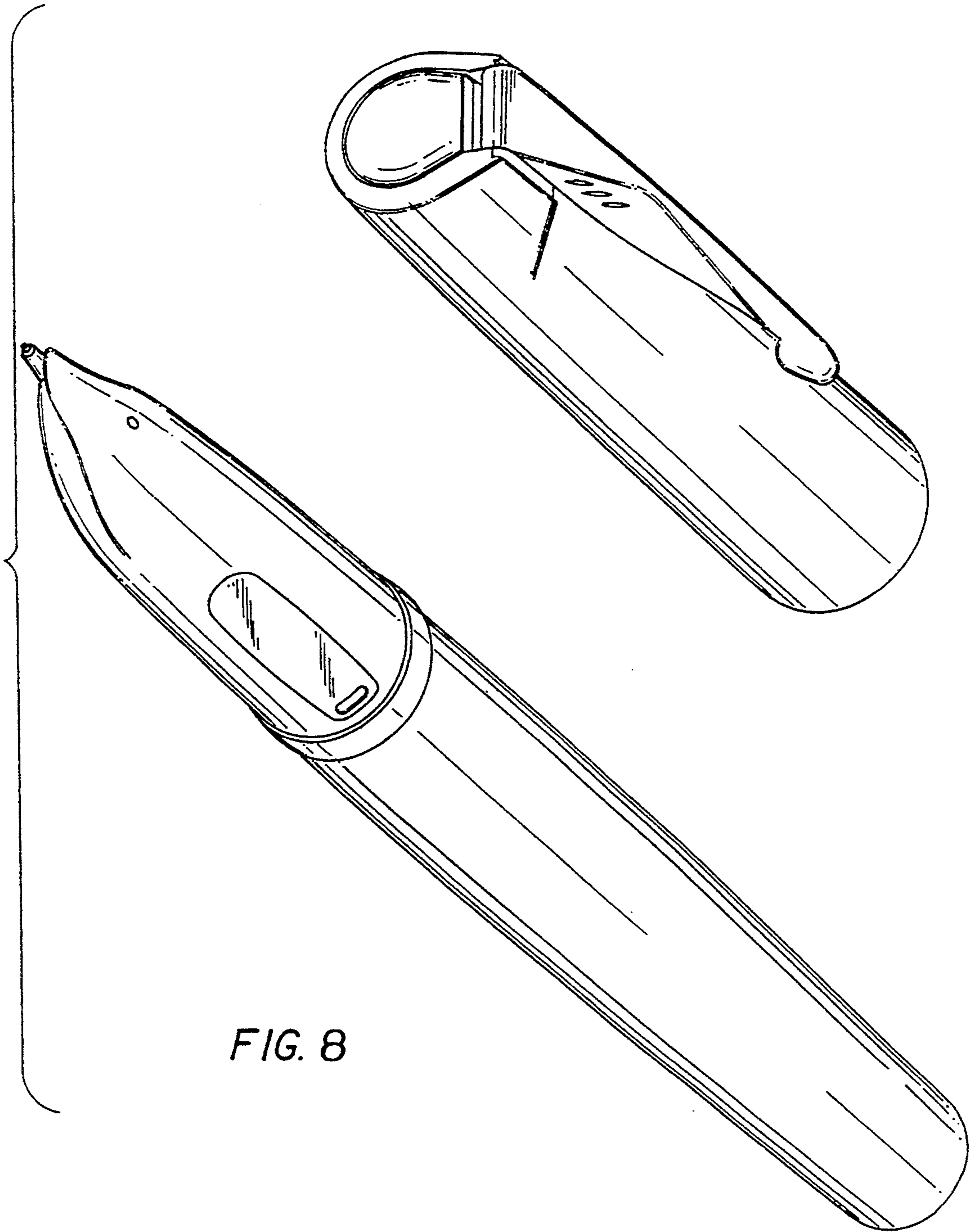

FIG. 8

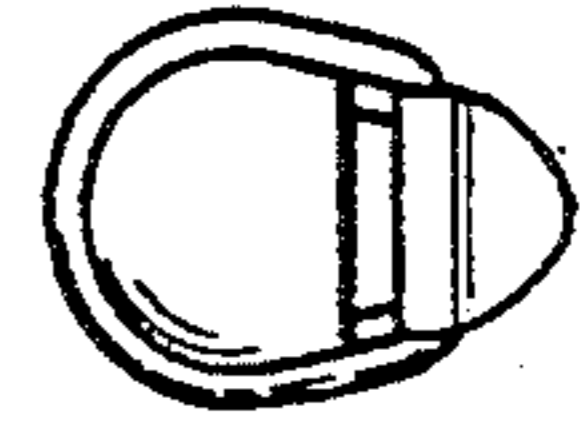

FIG. 12

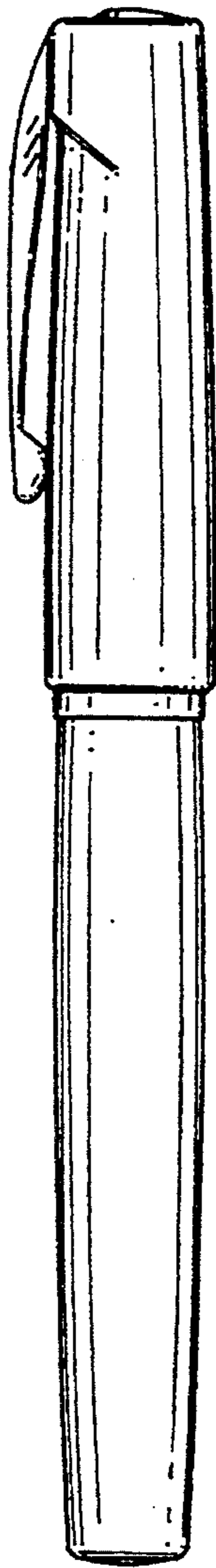

FIG. 9

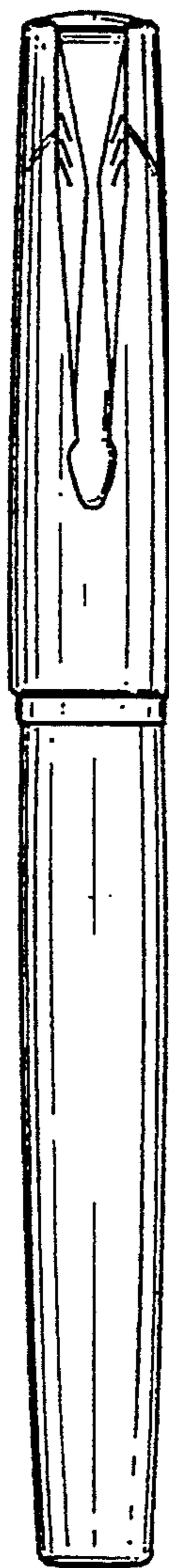

FIG. 10

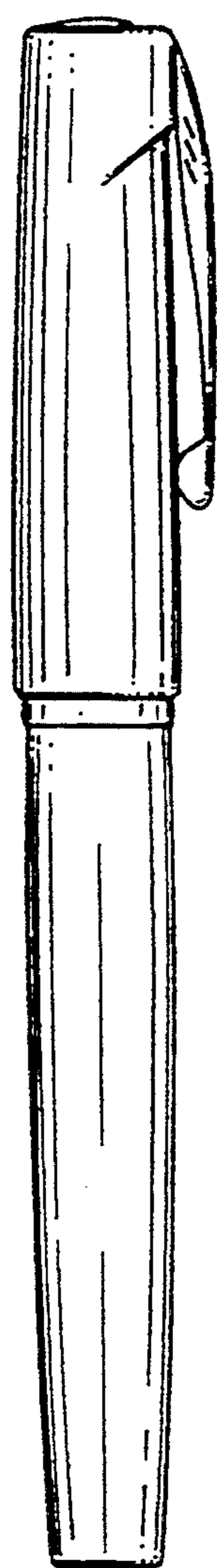

FIG. 11



FIG. 13



FIG. 17



FIG. 14

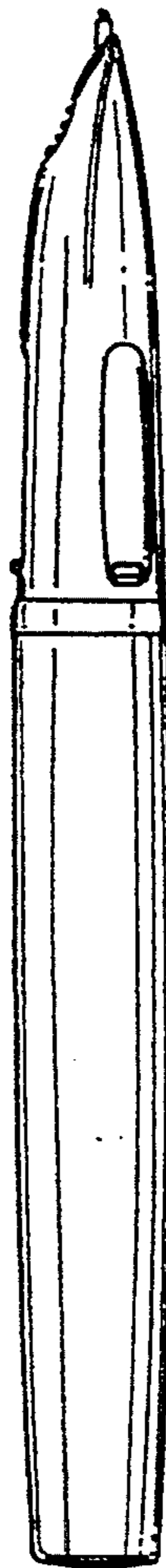

FIG. 15

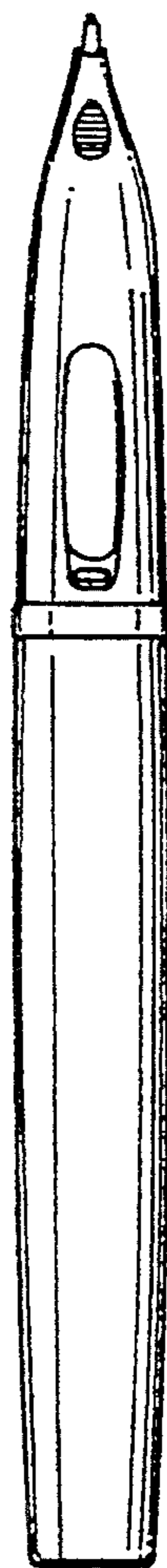

FIG. 16

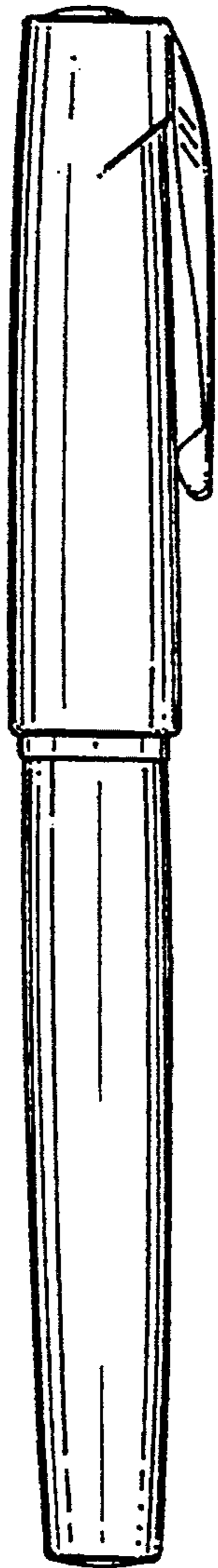

FIG. 18

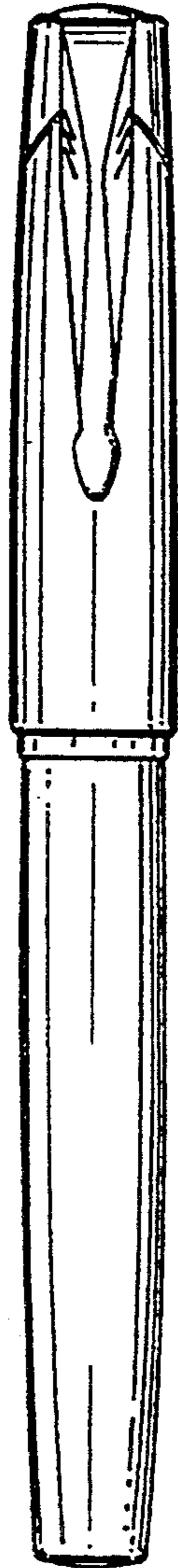

FIG. 19

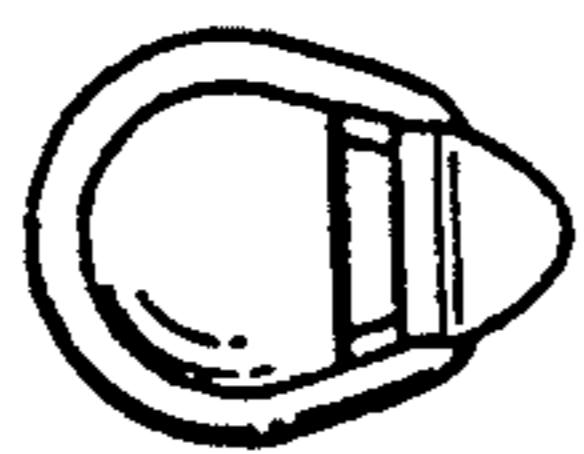

FIG. 20

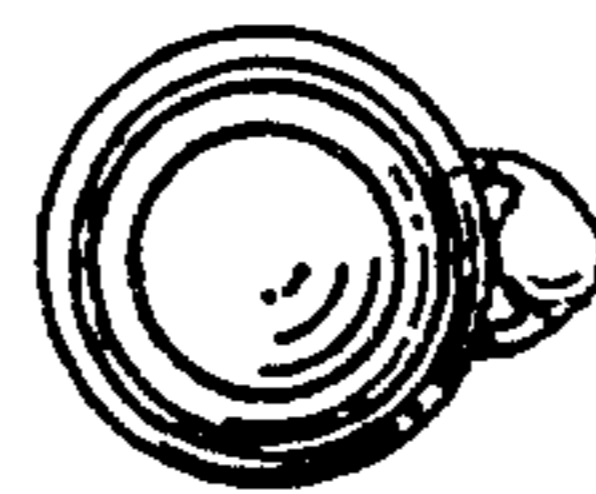

FIG. 21

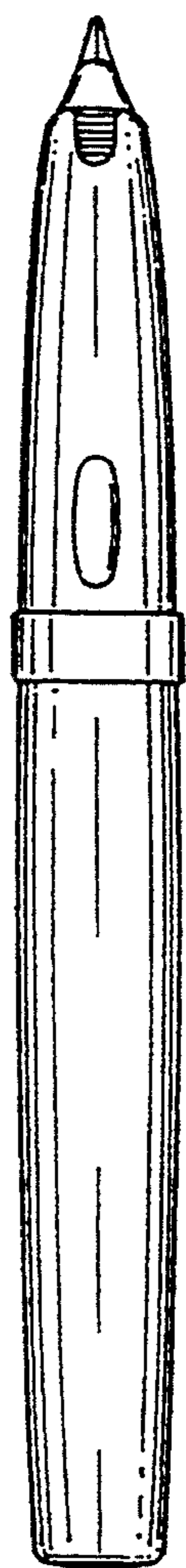

FIG. 22



FIG. 23

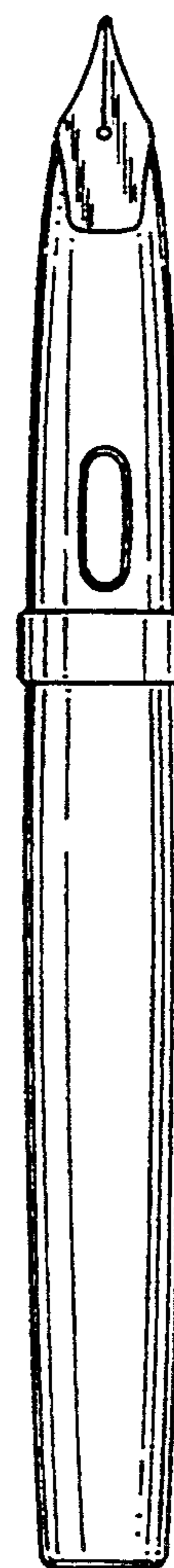

FIG. 24

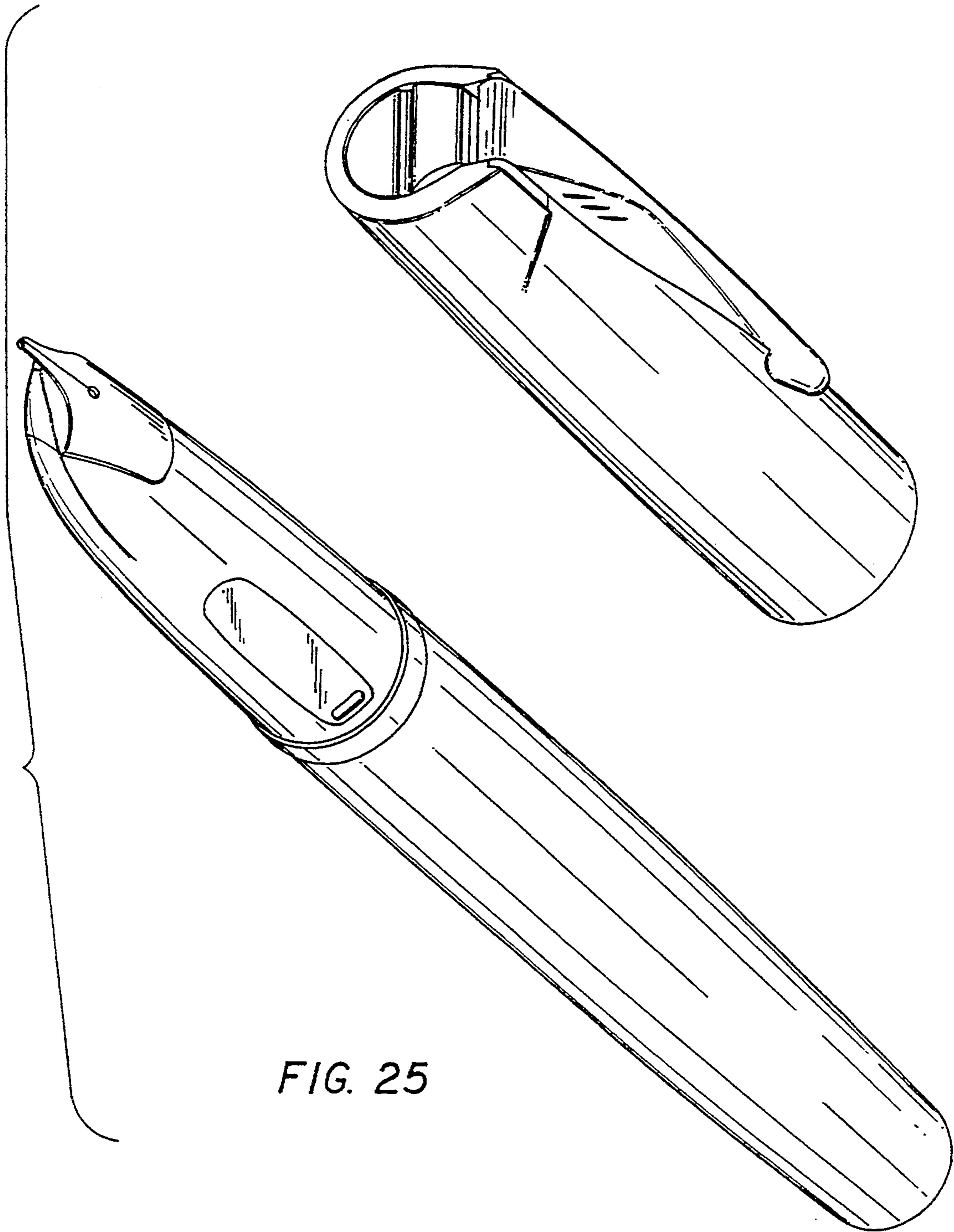

FIG. 25

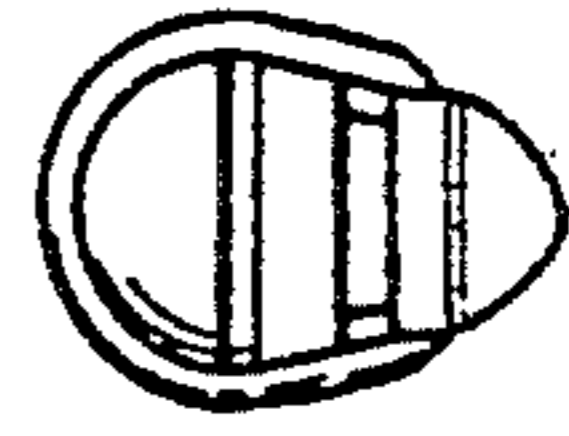

FIG. 29

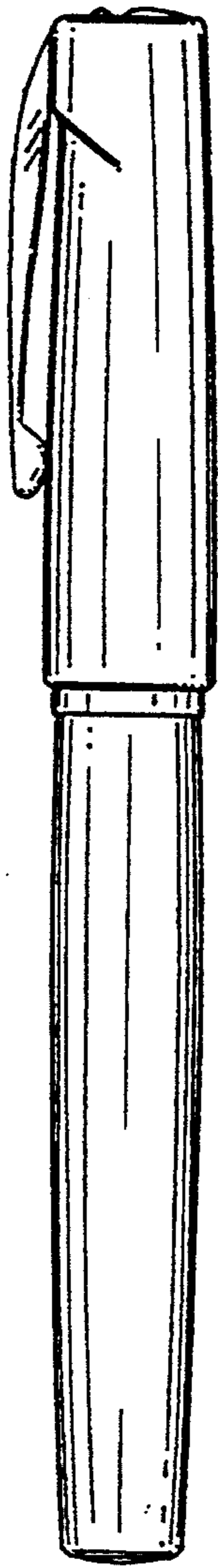

FIG. 26

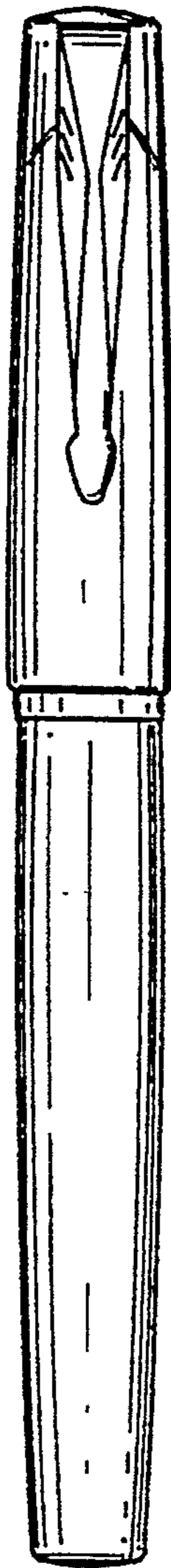

FIG. 27

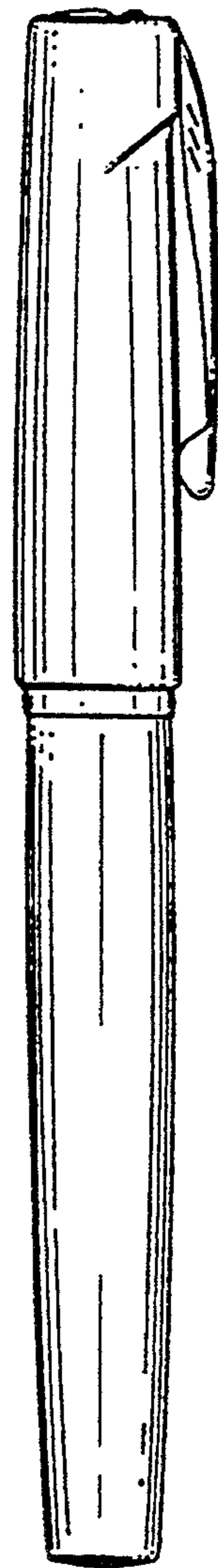

FIG. 28

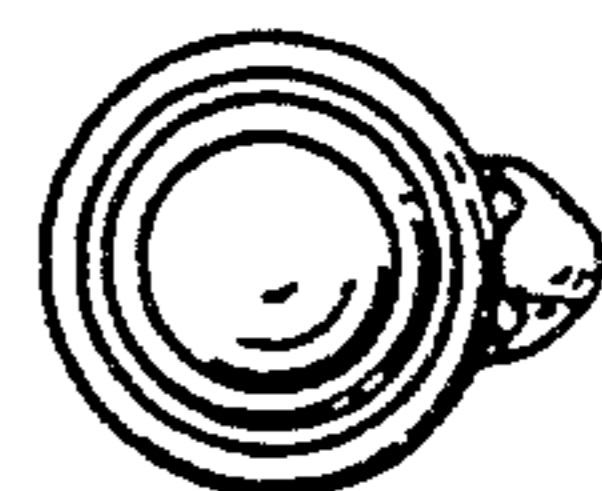

FIG. 30

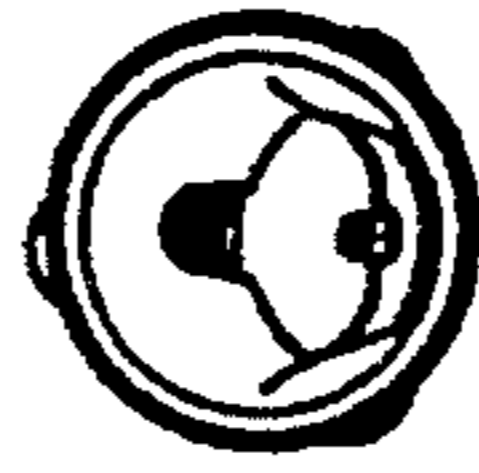

FIG. 34



FIG. 31



FIG. 32



FIG. 33