



US00D362176S

United States Patent [19]

[11] Patent Number: **Des. 362,176**

Solbeck

[45] Date of Patent: **** Sep. 12, 1995**

[54] **FASTENER FOR ATTACHING EYELETS OF TARPAULINS AND OTHER WEATHERPROOF COVERS TO ANCHORING AND LOCKING DEVICES**

1,900,574	3/1933	Meader	24/453
3,369,653	2/1968	Edwards	411/509
3,805,816	4/1974	Nolte	.
4,952,107	8/1990	Dupree	411/508
4,973,212	11/1990	Jacobs	24/453

[75] Inventor: **Peter Solbeck**, Rungsted Kyst, Denmark

FOREIGN PATENT DOCUMENTS

[73] Assignee: **Polysheet A/S**, Herlev, Denmark

WO9114842 10/1991 WIPO .

[**] Term: **14 Years**

Primary Examiner—B. J. Bullock
Attorney, Agent, or Firm—Beveridge, DeGrandi, Weilacher & Young

[21] Appl. No.: **3,845**

[22] Filed: **Jan. 19, 1993**

[57] CLAIM

[30] Foreign Application Priority Data

The ornamental design for a fastener for attaching eyelets of tarpaulins and other weatherproof covers to anchoring and locking devices, as shown.

Jul. 20, 1992 [DK] Denmark 690/92

[52] U.S. Cl. **D8/382**

[58] Field of Search D8/382, 394; 411/500, 411/508, 509; 24/96, 453

DESCRIPTION

[56] References Cited

U.S. PATENT DOCUMENTS

D. 302,241	7/1989	Solbeck	D8/382
D. 330,324	10/1992	Solbeck	D8/394
D. 339,521	9/1993	Bartlett et al.	D8/394
D. 342,668	12/1993	Rose et al.	D8/394

FIG. 1 is a bottom view of a fastener for attaching eyelets of tarpaulins and other weatherproof covers to anchoring and locking devices showing my new design; FIG. 2 is a front view thereof; FIG. 3 is a top view thereof; FIG. 4 is a side view thereof; and, FIG. 5 is a sectional view taken in the direction of the arrows on line 5—5 in FIG. 4.

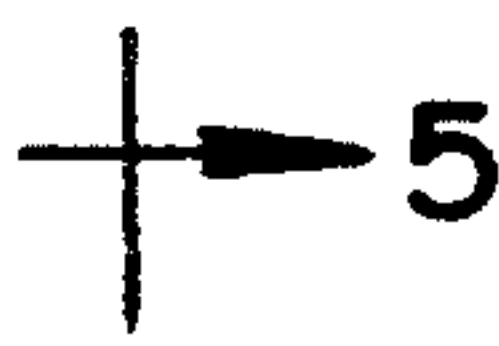
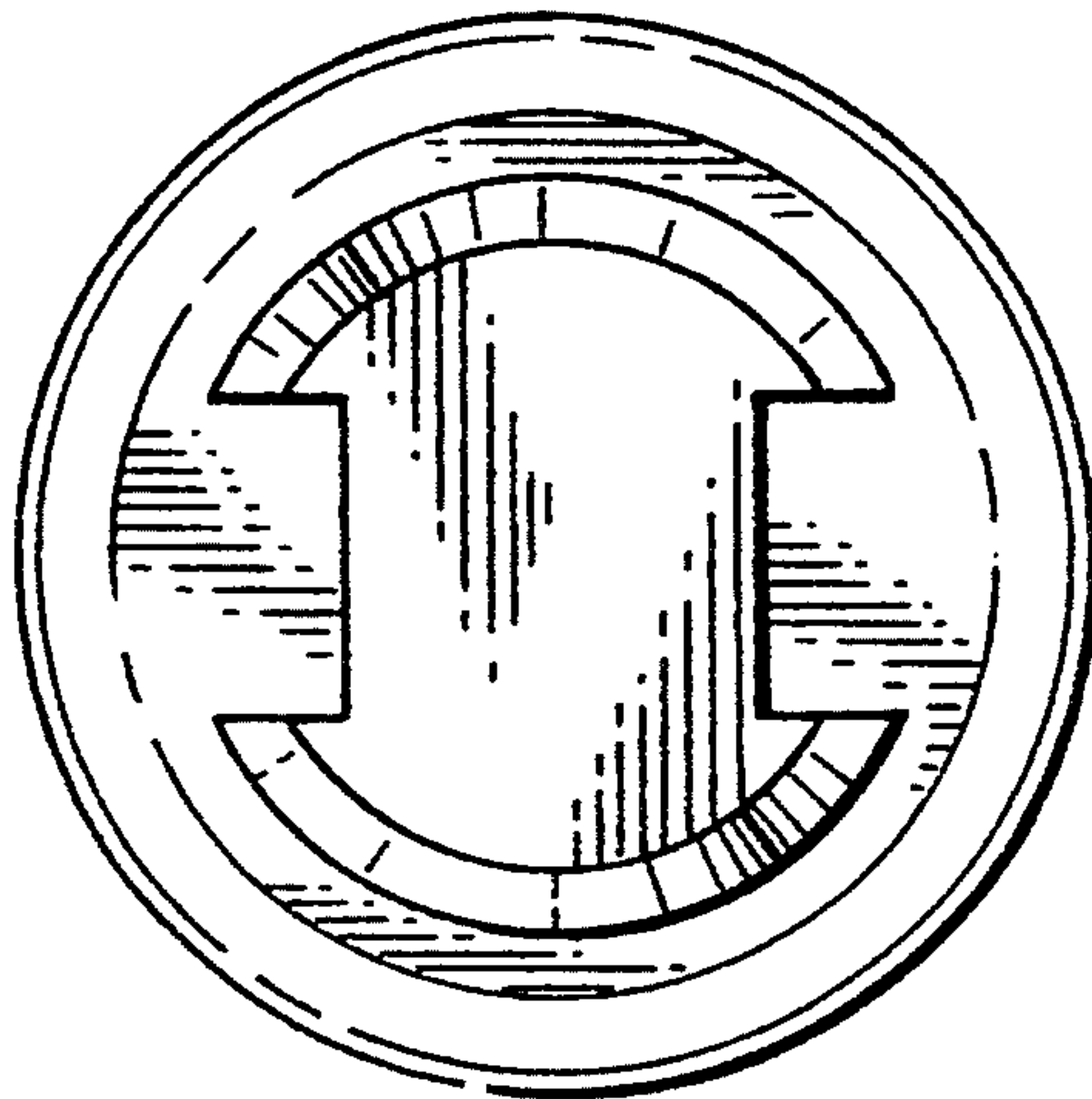

FIG. 1

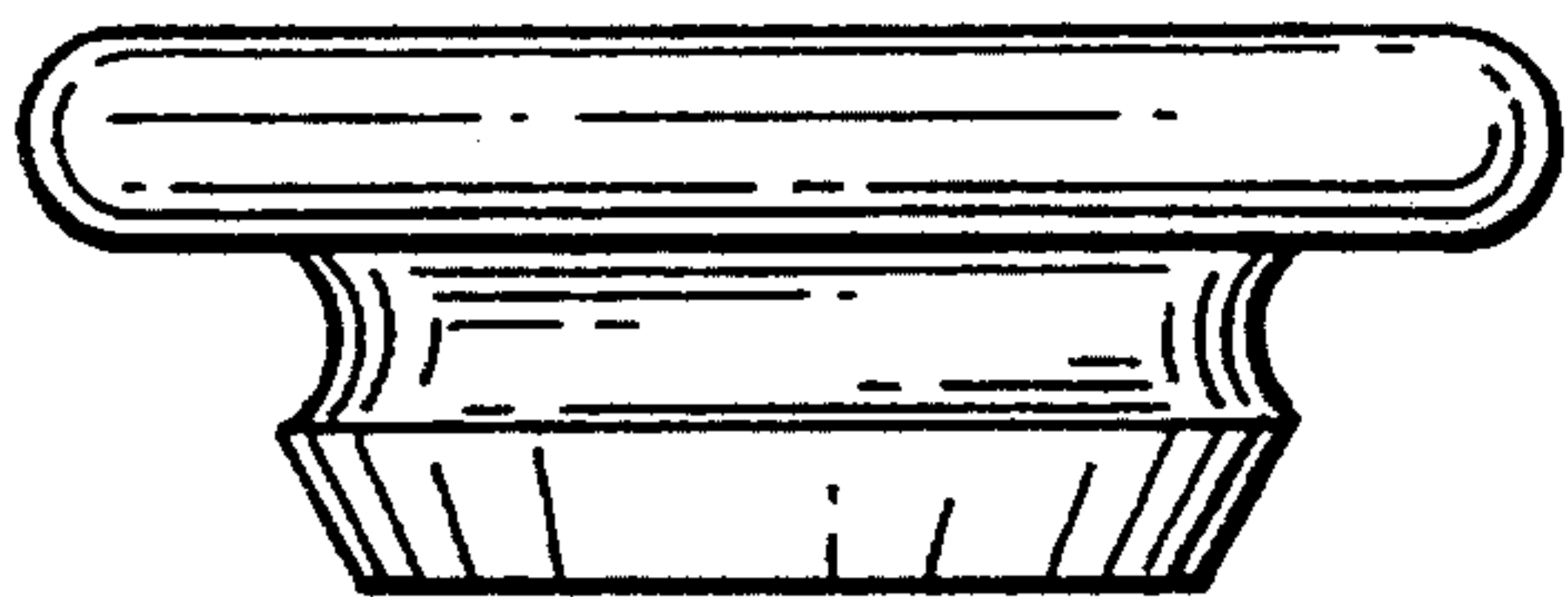
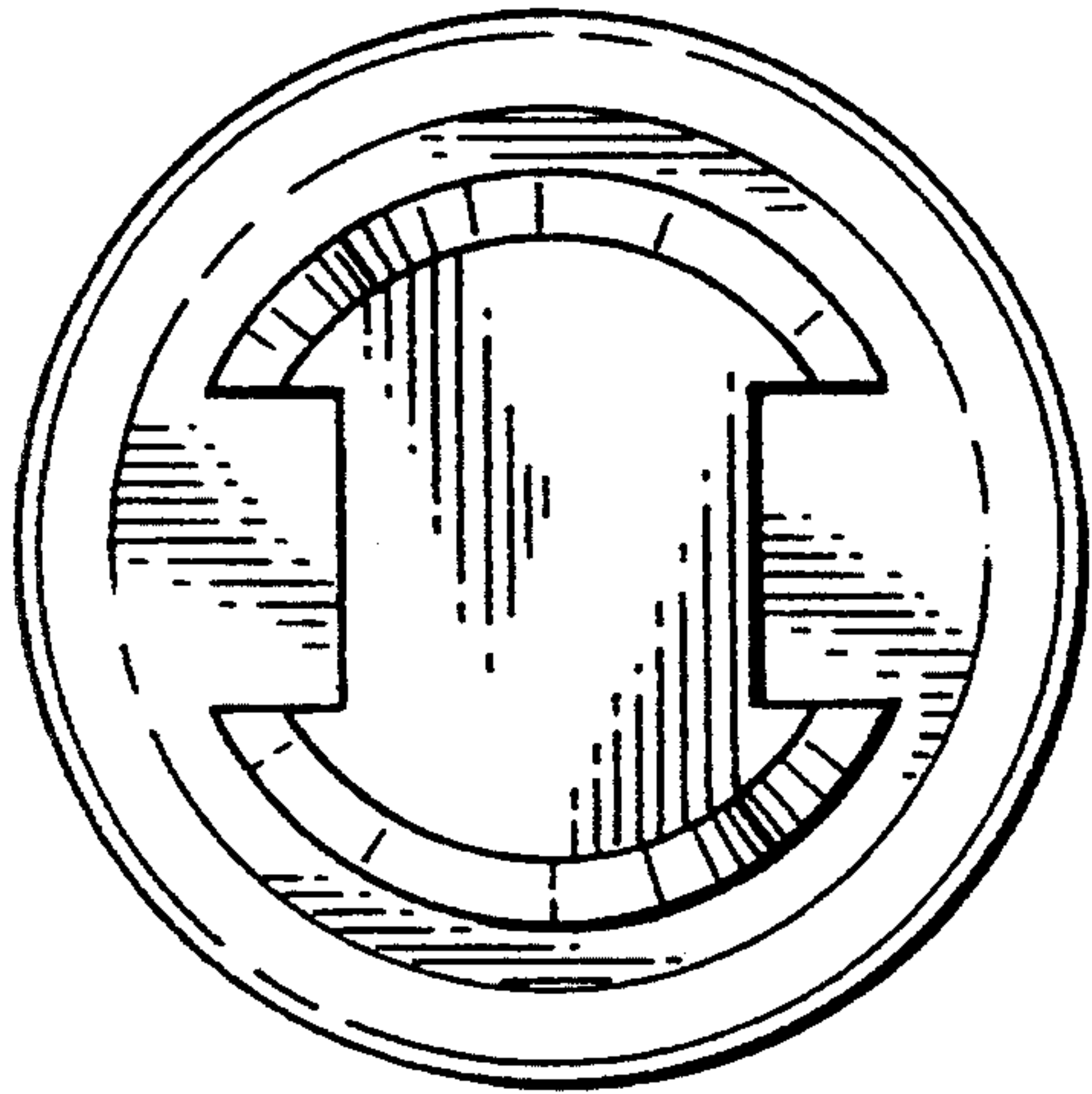

FIG. 2

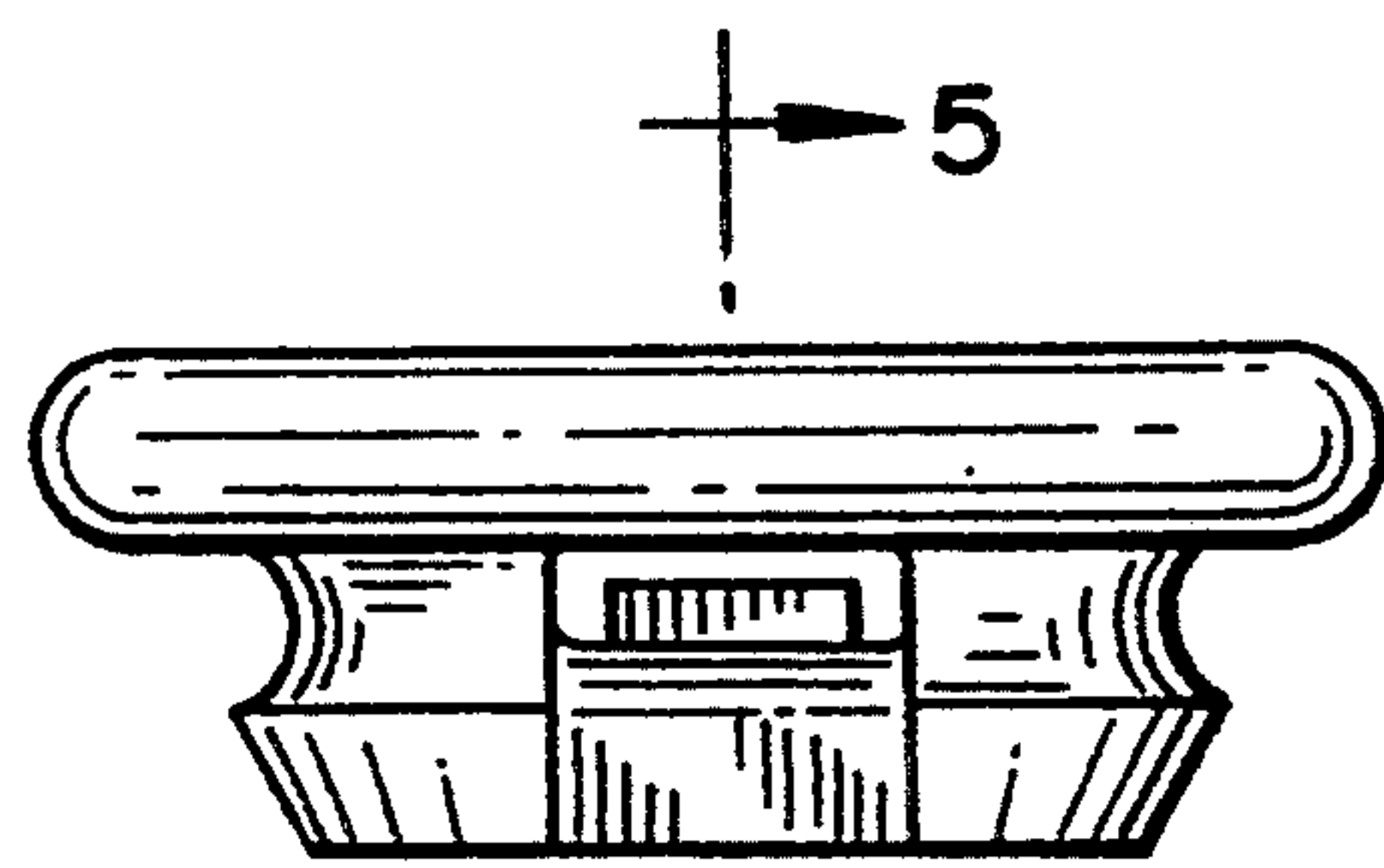

FIG. 4

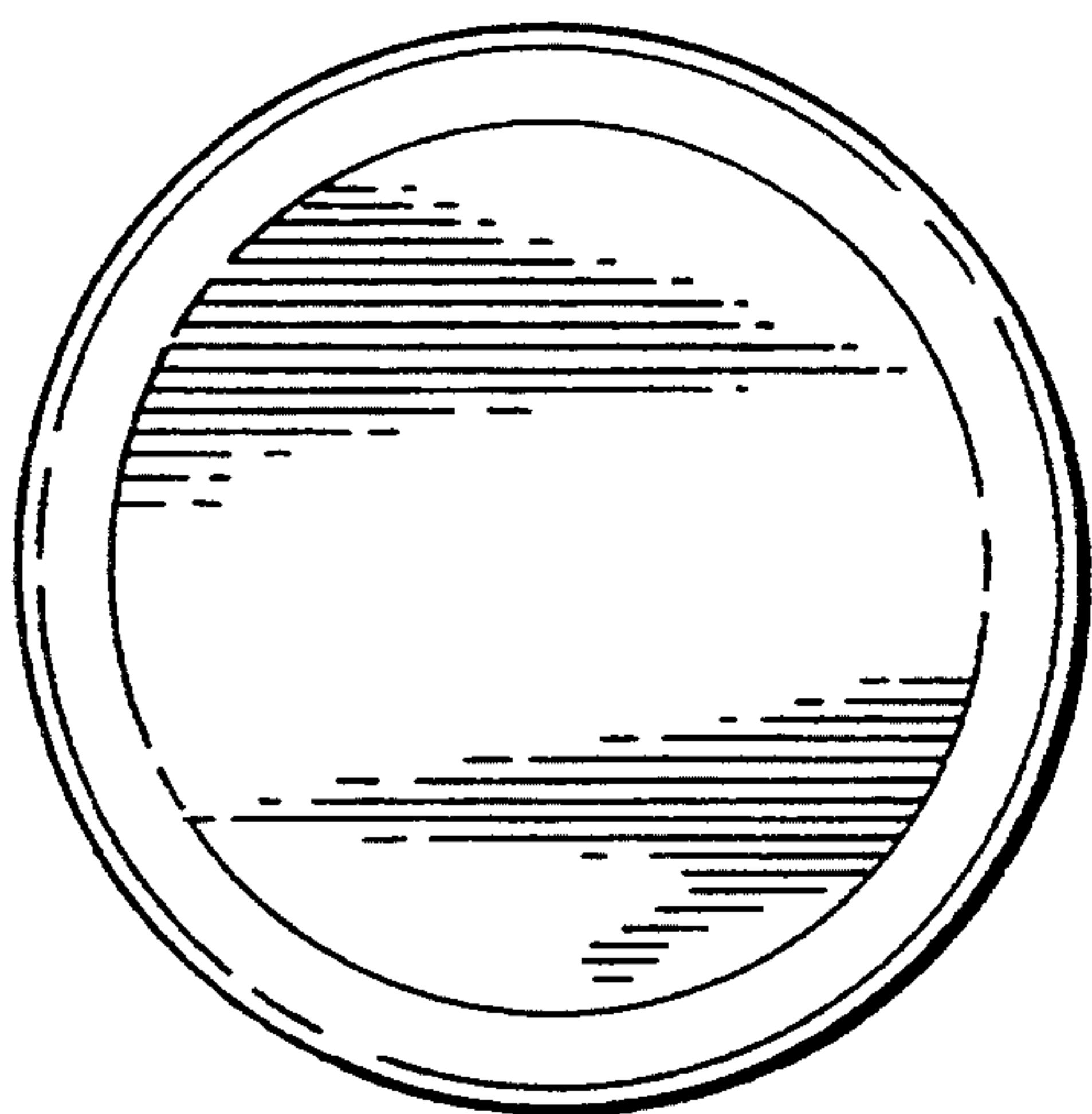

FIG. 3

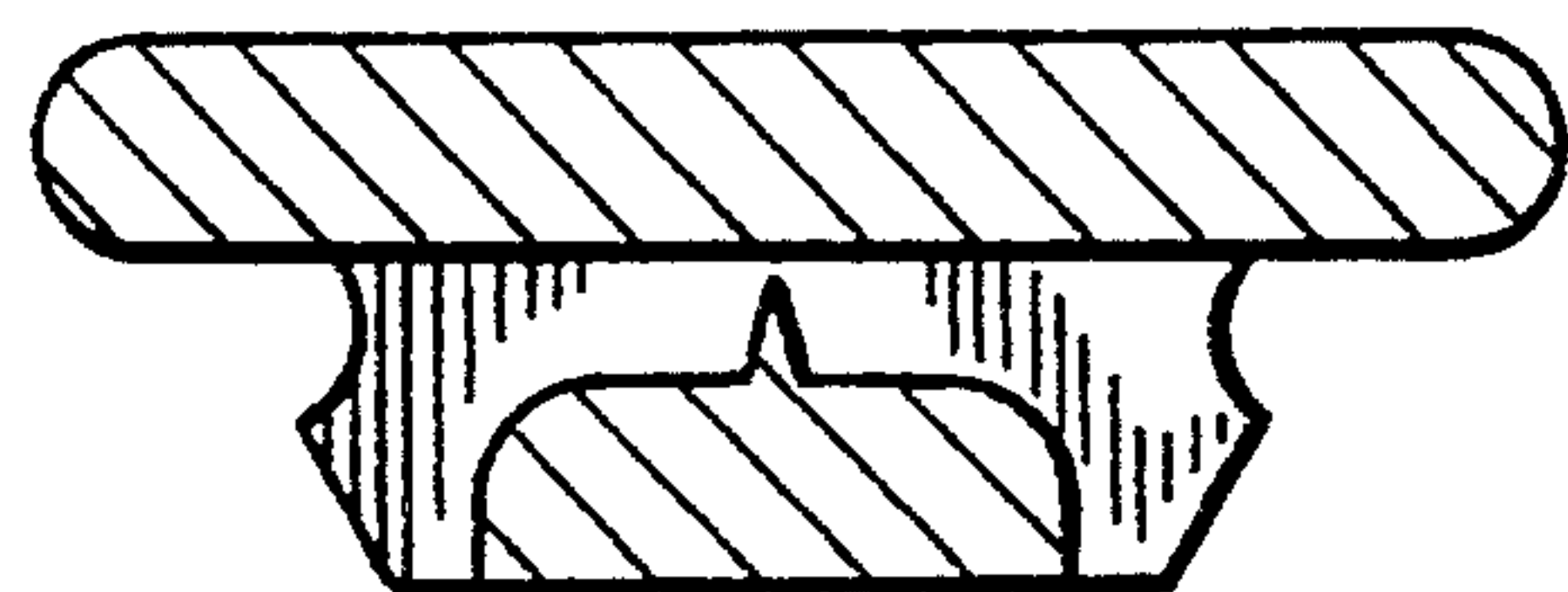

FIG. 5