



US00D362109S

United States Patent [19]

[11] Patent Number: **Des. 362,109**

Jones

[45] Date of Patent: **** Sep. 12, 1995**

[54] **SHOE CHAIN**

2,714,768 8/1955 Badler 36/1

[76] Inventor: **Herbert E. Jones**, 109 W. Young St.,
Rose Hill, Kans. 67133

Primary Examiner—Stella Reid
Assistant Examiner—E. Watterson

[**] Term: **14 Years**

[57] **CLAIM**

[21] Appl. No.: **18,179**

The ornamental design for a shoe chain, as shown and described.

[22] Filed: **Jan. 31, 1994**

[52] U.S. Cl. **D2/962**

[58] Field of Search D2/946, 962; 36/1, 7.6,
36/11.5, 61, 62, 132, 136, 106, 59 R

DESCRIPTION

[56] **References Cited**

U.S. PATENT DOCUMENTS

D. 336,559	6/1993	Carmichael	D2/962
1,978,711	10/1994	Keely	36/113 X
2,450,768	10/1948	Pulver	D2/962 X
2,532,485	12/1950	Dowling	36/132 X

FIG. 1 is a front elevational view of the shoe chain showing my new design;

FIG. 2 is a rear elevational view thereof;

FIG. 3 is a left side elevational view thereof;

FIG. 4 is a right side elevational view thereof;

FIG. 5 is a top plan view thereof;

FIG. 6 is a bottom plan view thereof; and,

FIG. 7 is a side elevational view thereof in use condition, the broken line showing is for illustrative purposes only and forms no part of the claimed design.

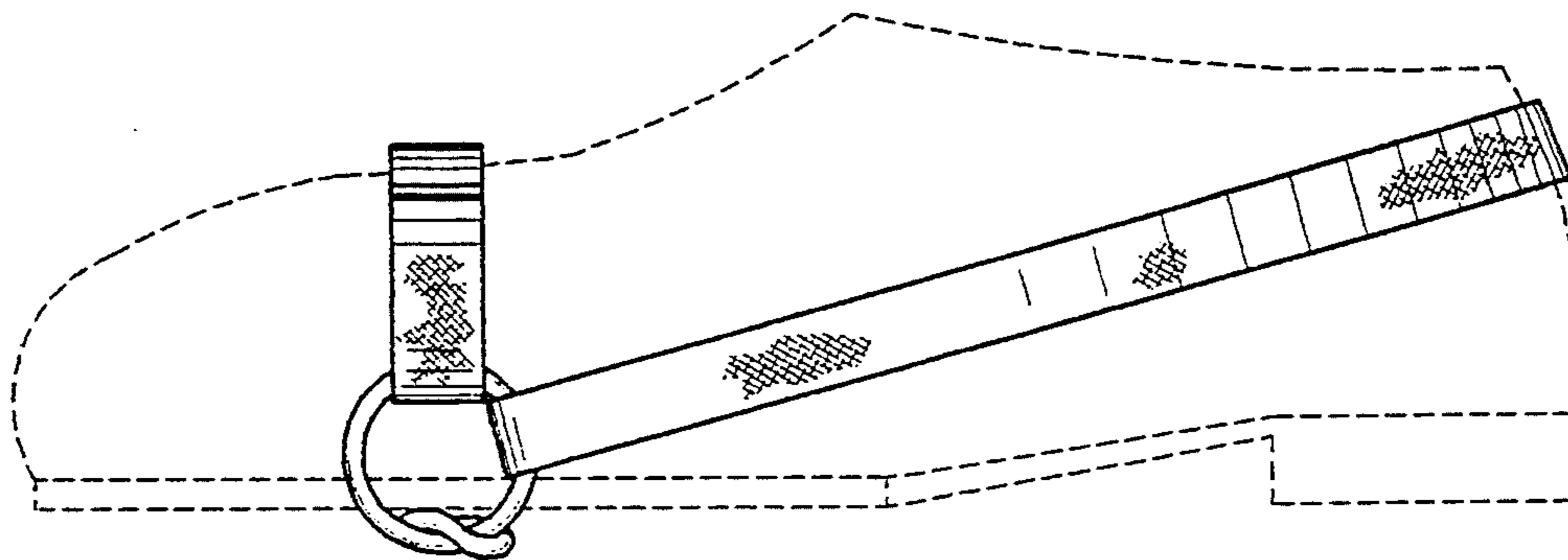

FIG. 1

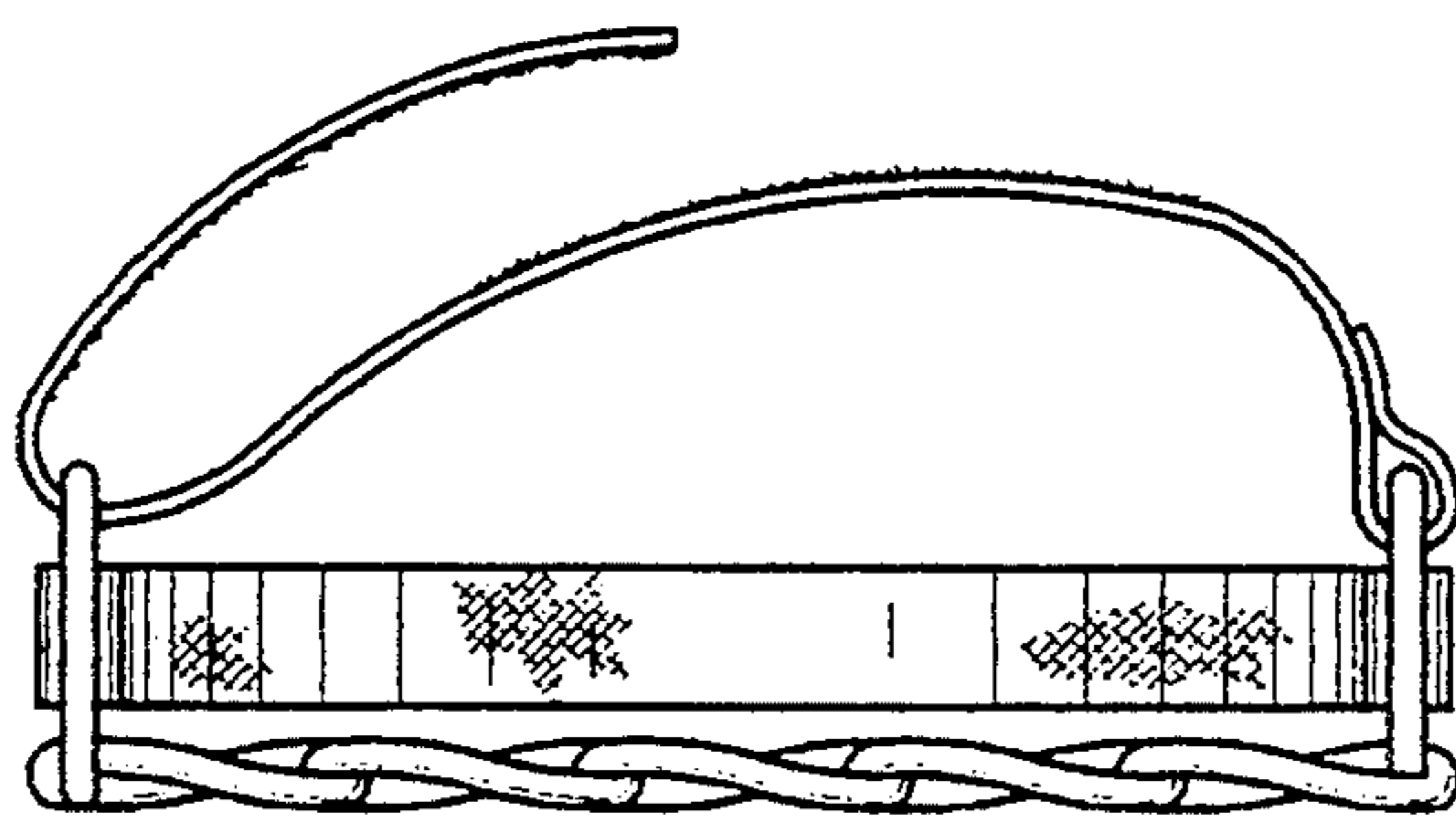

FIG. 2

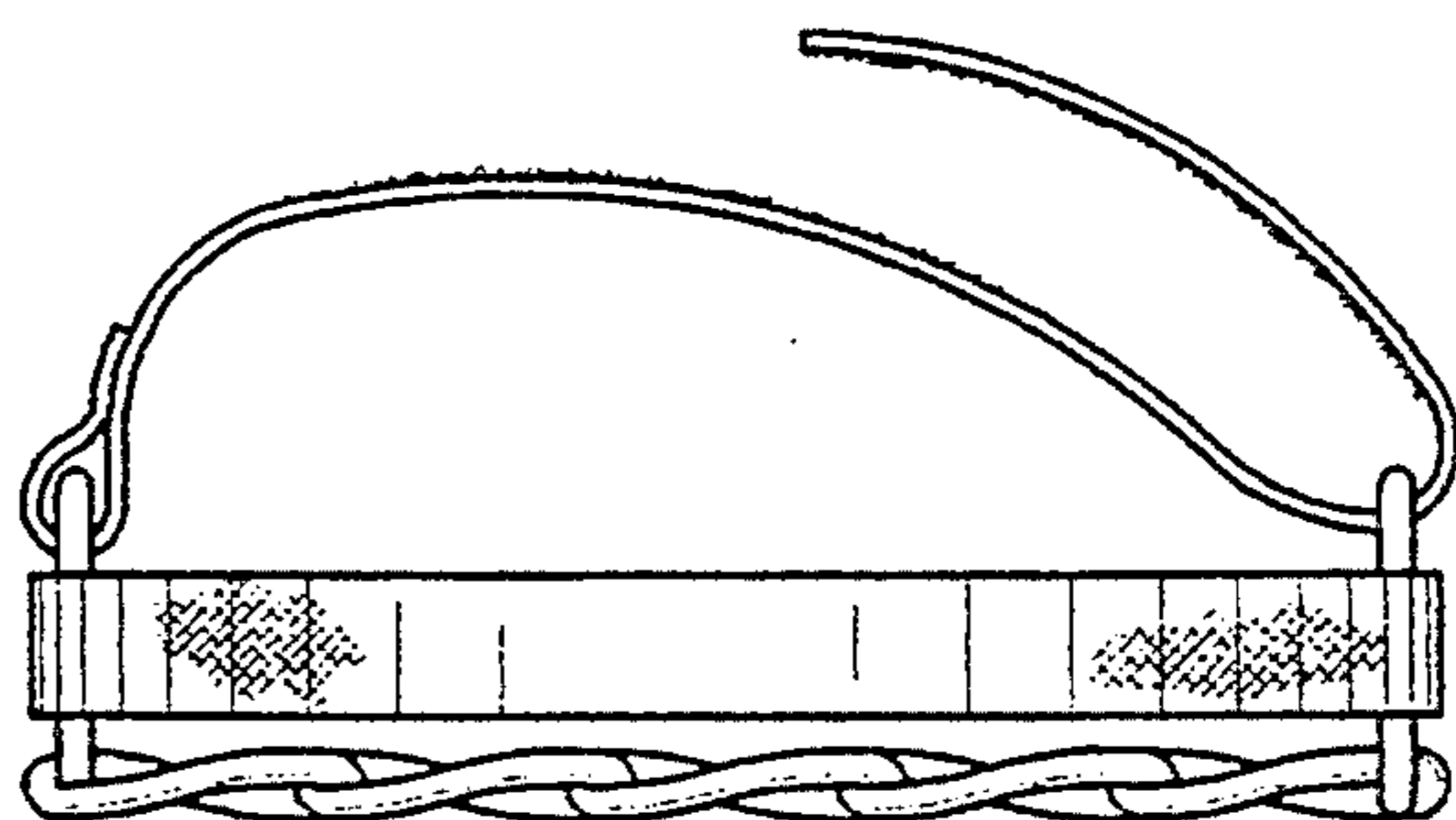

FIG. 3

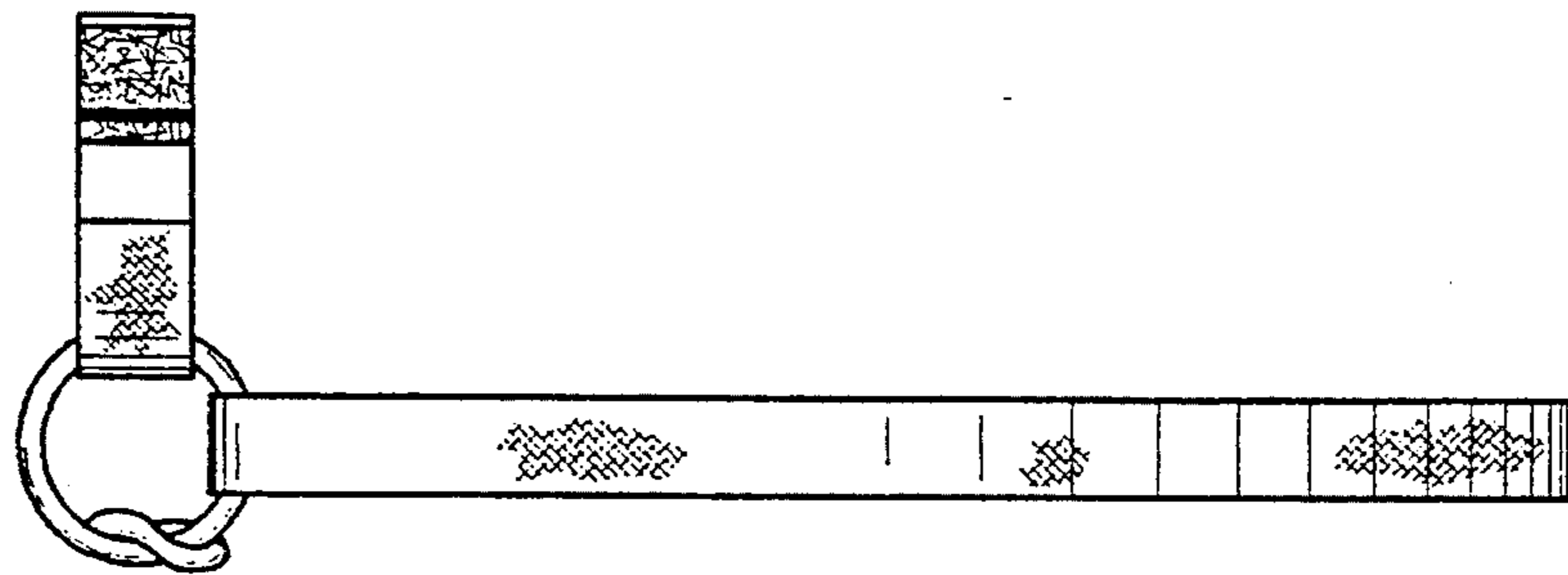

FIG. 4

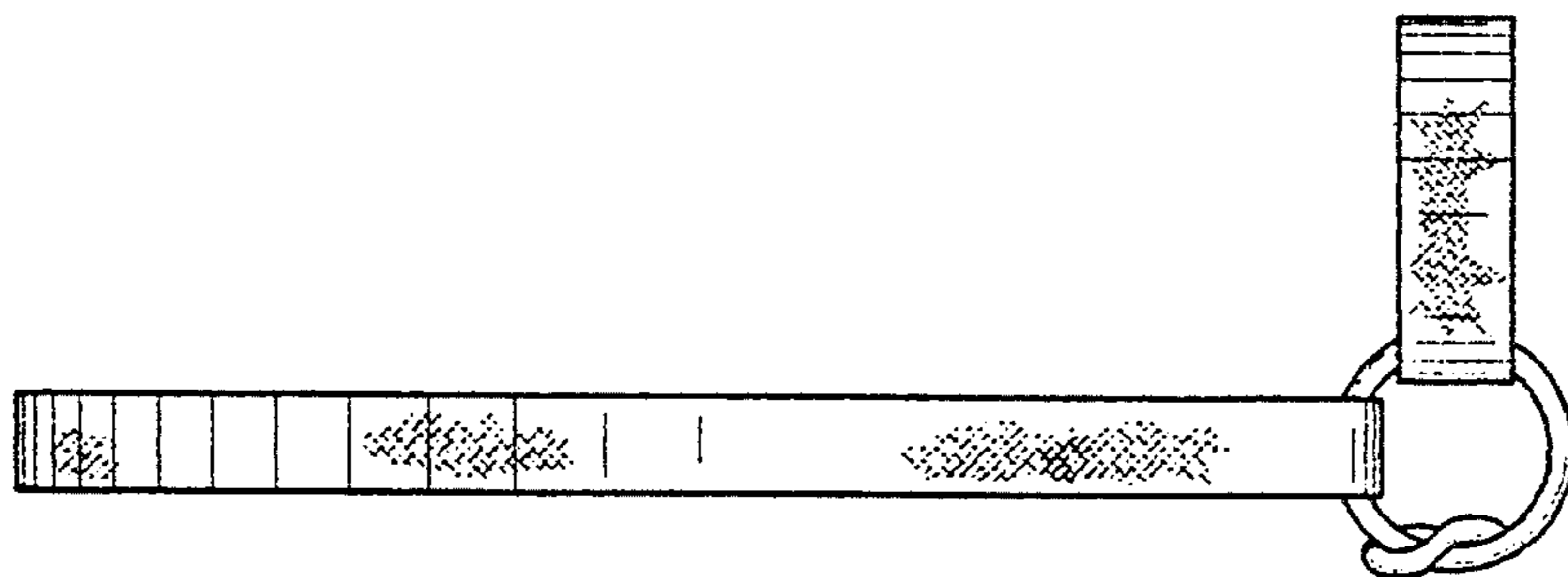

FIG. 5

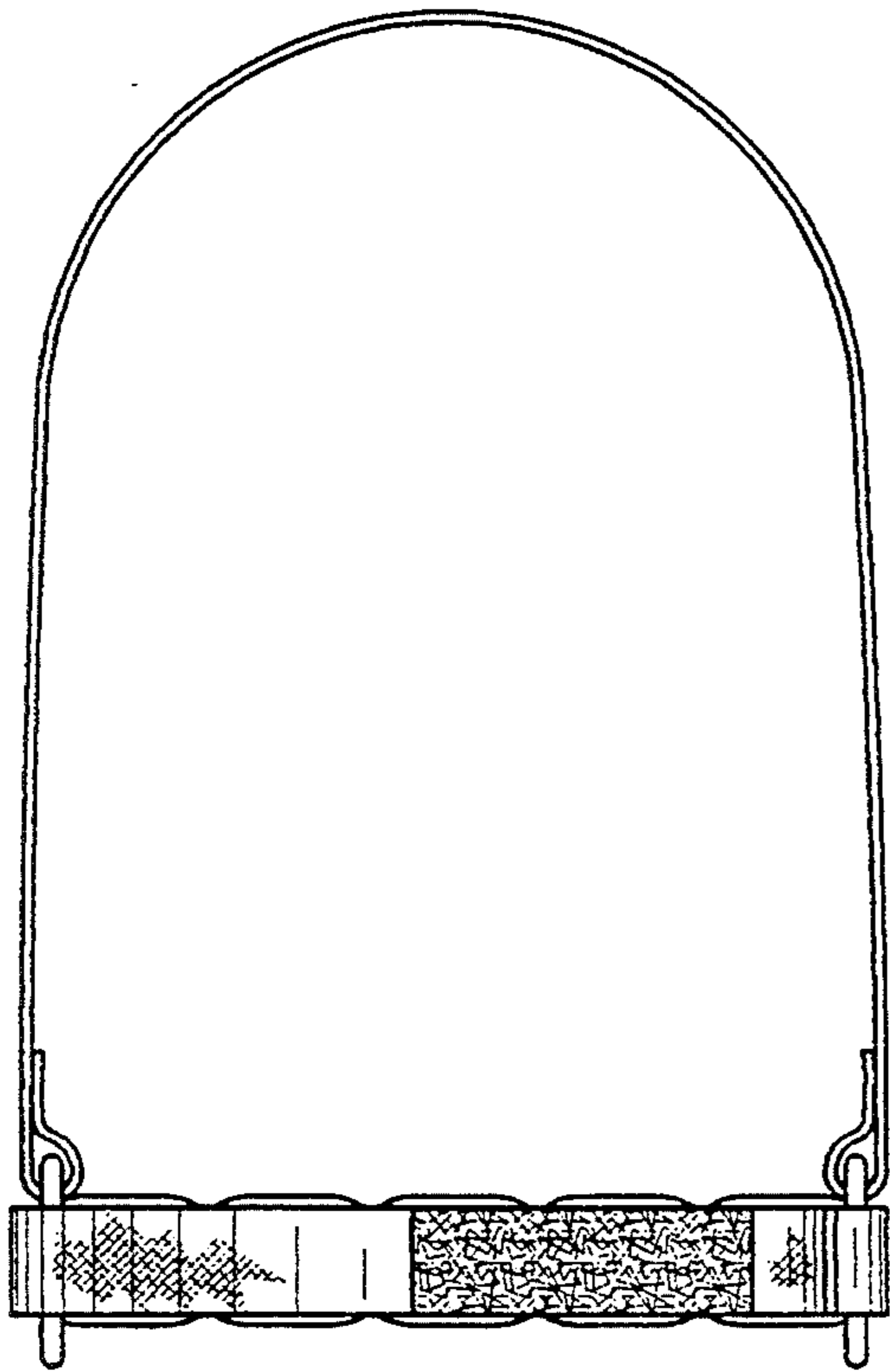

FIG. 6

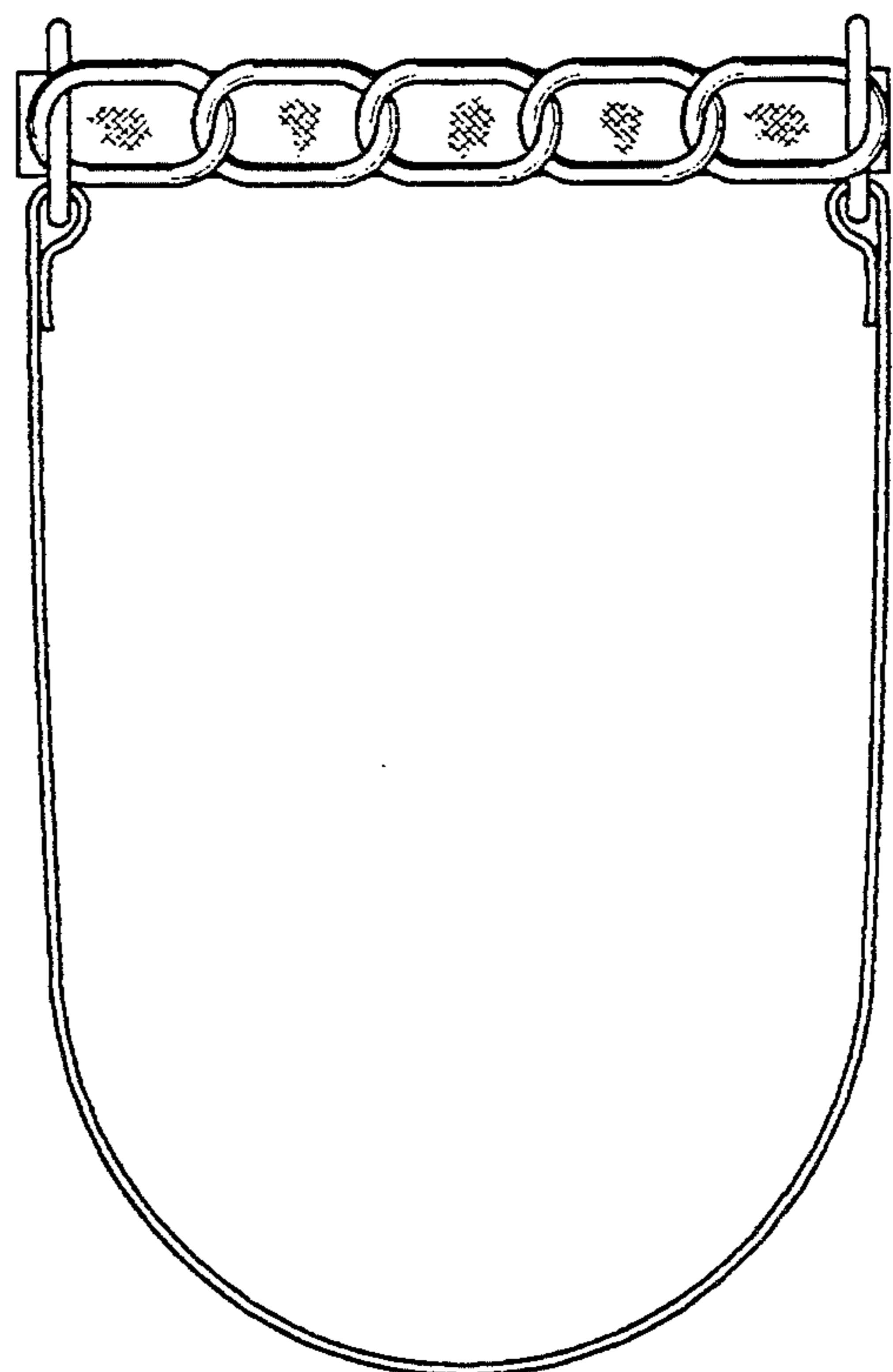

FIG. 7

