



US00D362071S

United States Patent [19]

[11] Patent Number: **Des. 362,071**

Ruiz

[45] Date of Patent: **** Sep. 5, 1995**

[54] **LEG IMMOBILIZER**

5,042,508 8/1991 Richard 128/882

[76] Inventor: **Jose G. Ruiz**, HC-02 Box 14546,
Carolina, P.R. 00985

Primary Examiner—Stella Reid

[**] Term: **14 Years**

[57] **CLAIM**

[21] Appl. No.: **21,268**

The ornamental design for a leg immobilizer, as shown and described.

[22] Filed: **Apr. 14, 1994**

DESCRIPTION

[52] U.S. Cl. **D24/190**

[58] Field of Search D24/190, 183, 184;
602/23, 24; 128/882, DIG. 20; 5/648-650

FIG. 1 is a front elevational view of a leg immobilizer showing my new design;

FIG. 2 is a rear elevational view thereof;

FIG. 3 is a left side elevational view thereof;

FIG. 4 is a right side elevational view thereof;

FIG. 5 is a top plan view thereof; and,

FIG. 6 is a bottom plan view thereof; and,

FIG. 7 is an isometric view thereof.

[56] **References Cited**

U.S. PATENT DOCUMENTS

4,299,213 11/1981 Violet 128/882
4,373,709 2/1983 Whitt D24/183 X

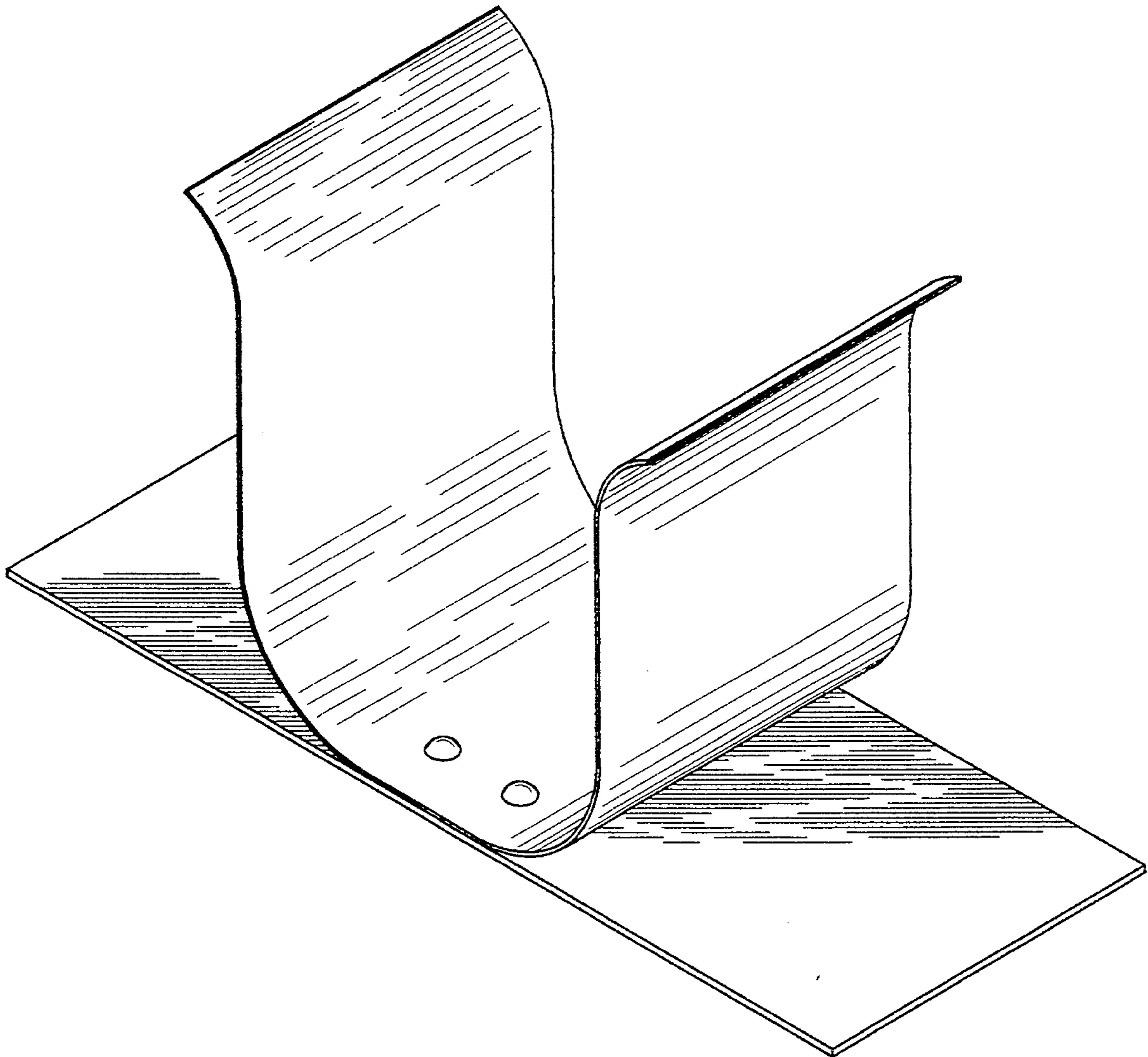

FIG. 1

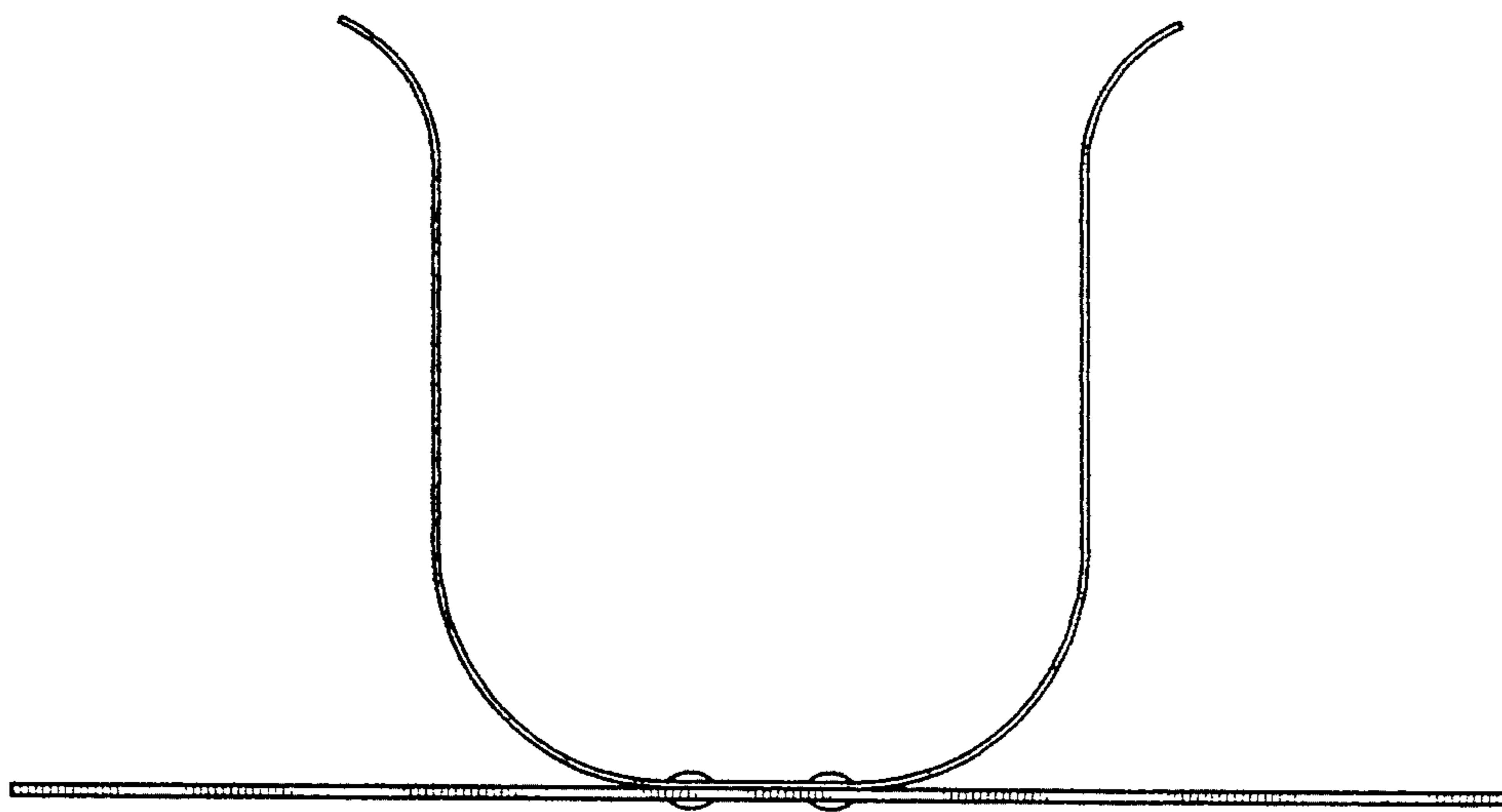

FIG. 2

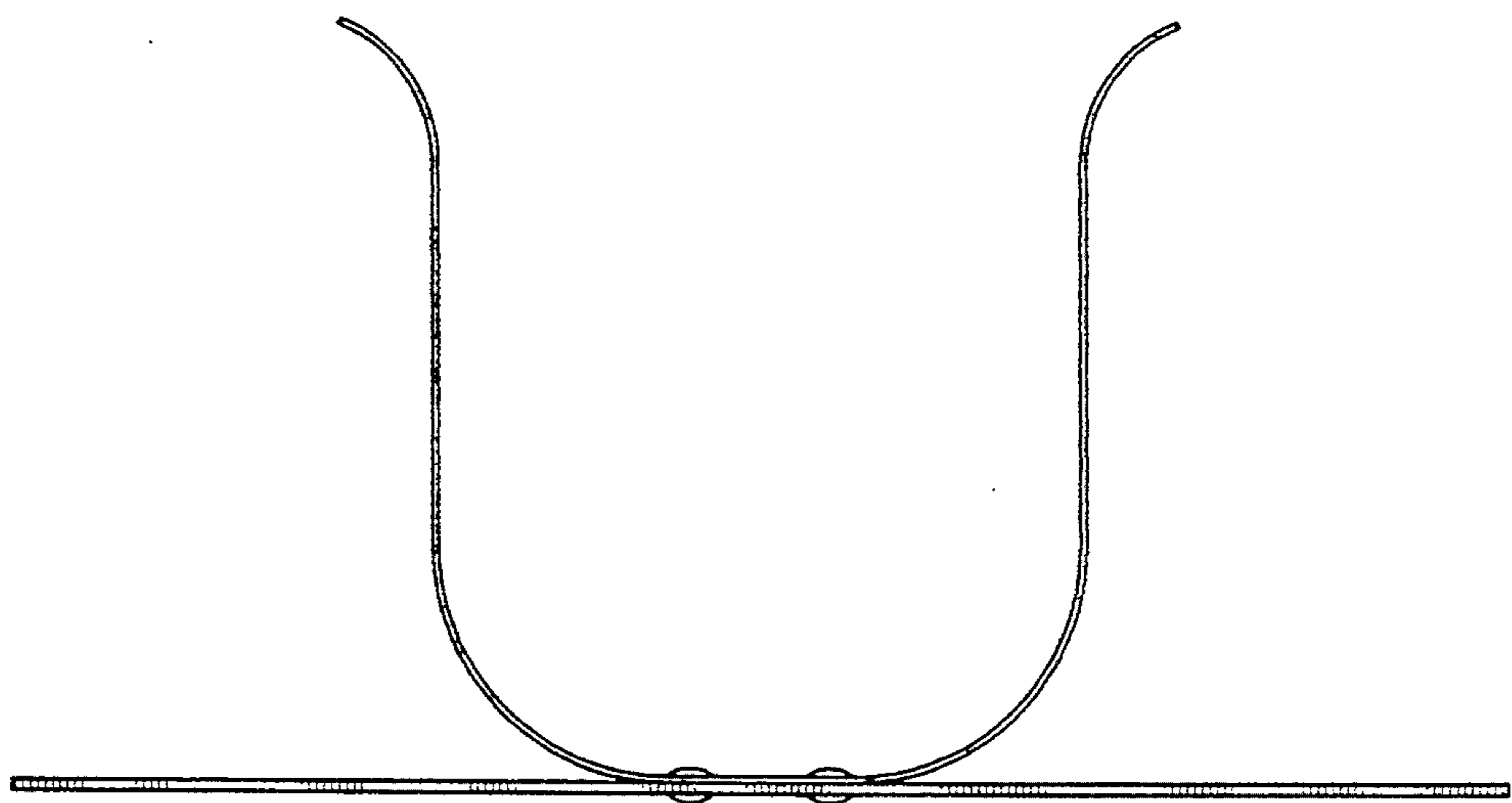

FIG. 3

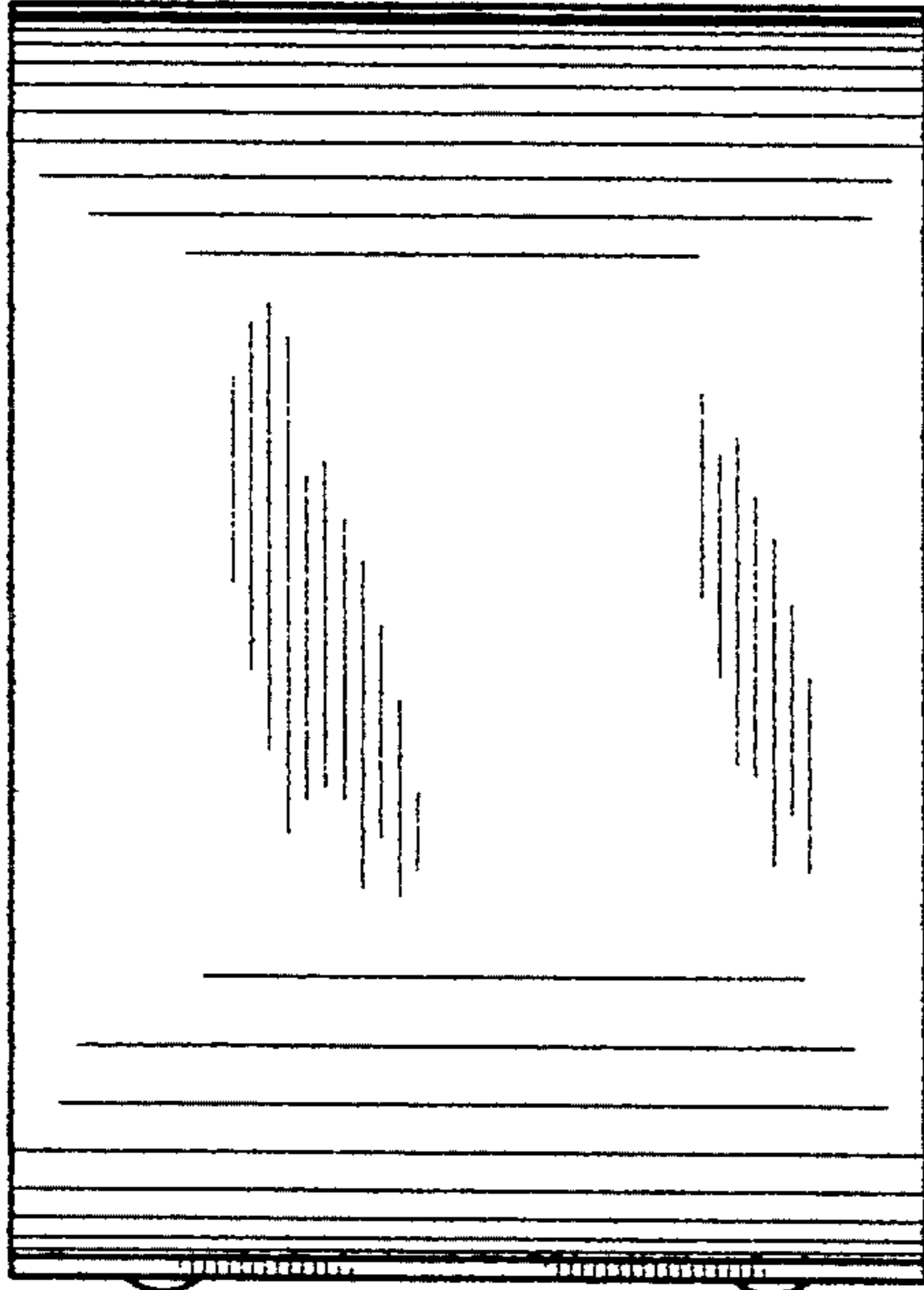

FIG. 4

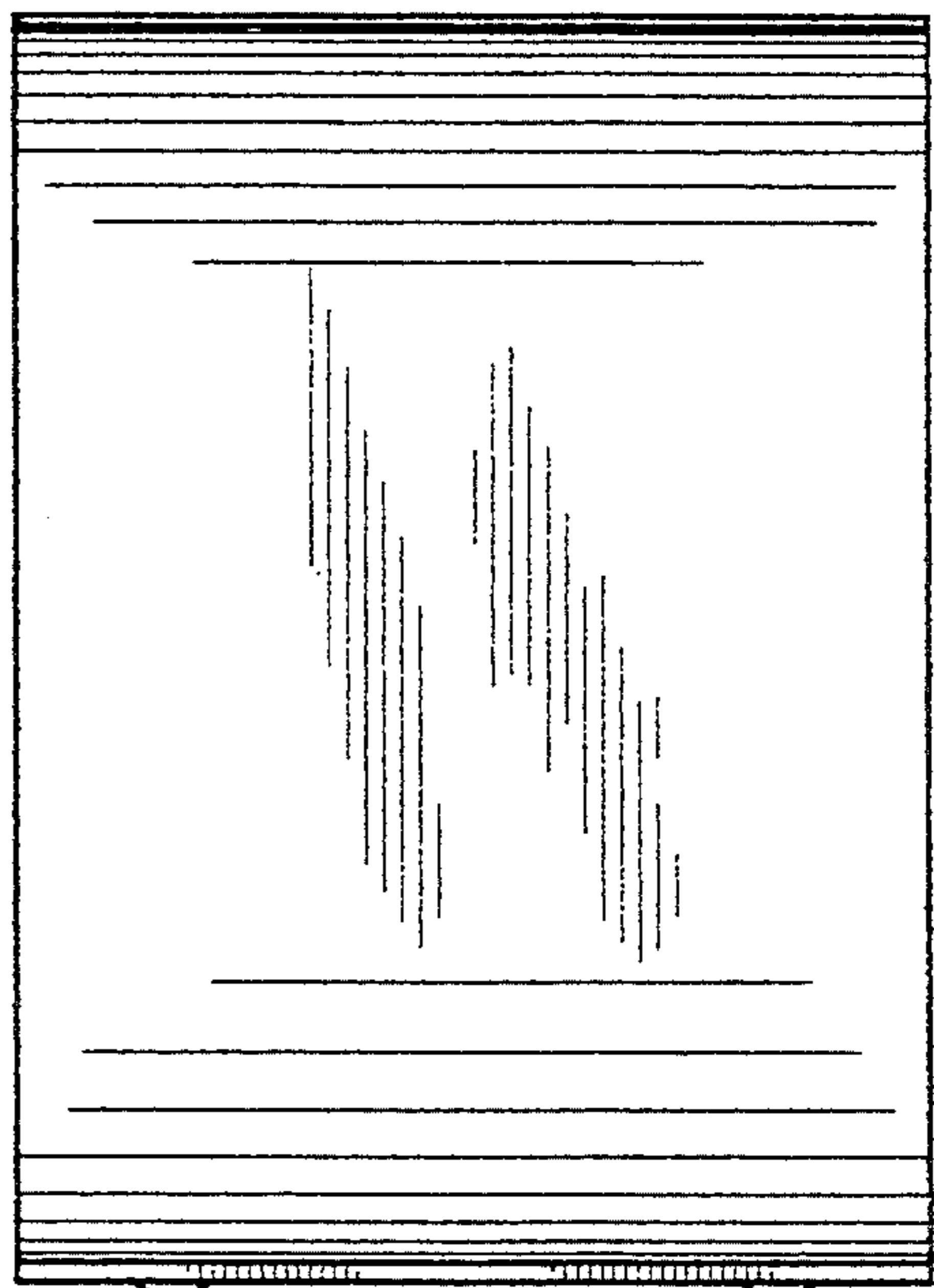

FIG. 5

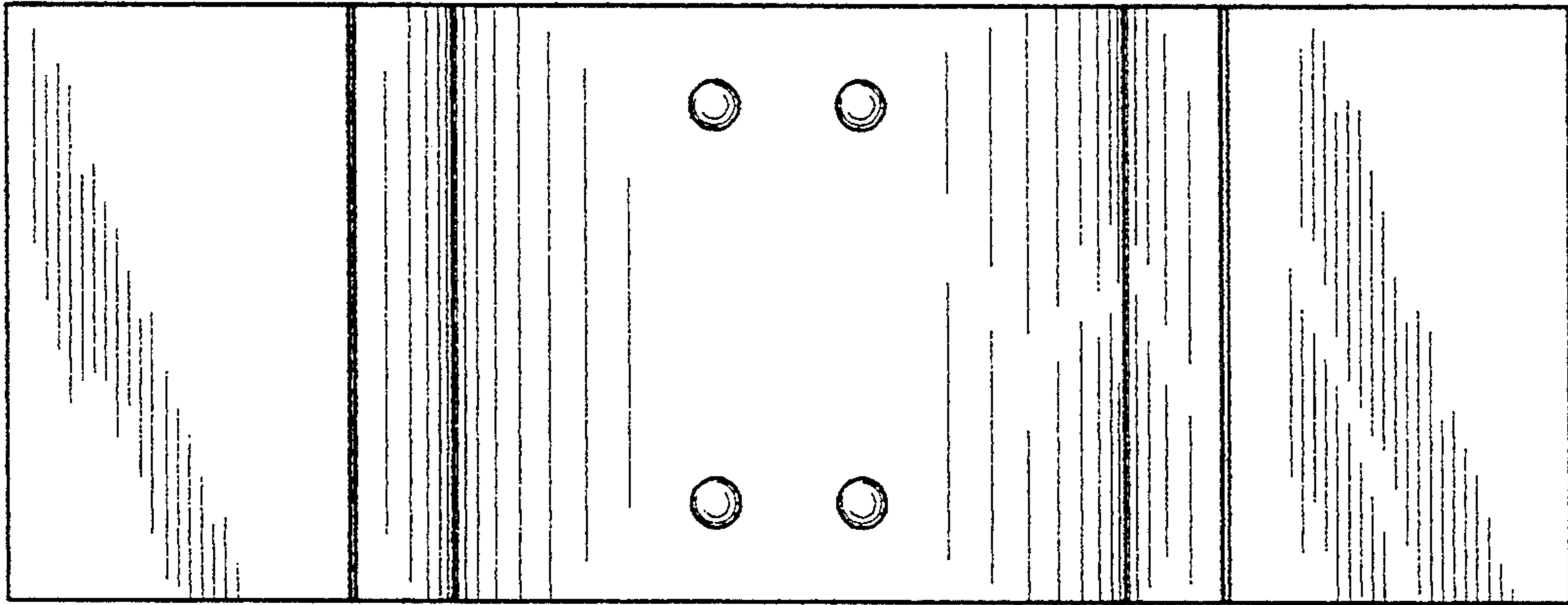

FIG. 6

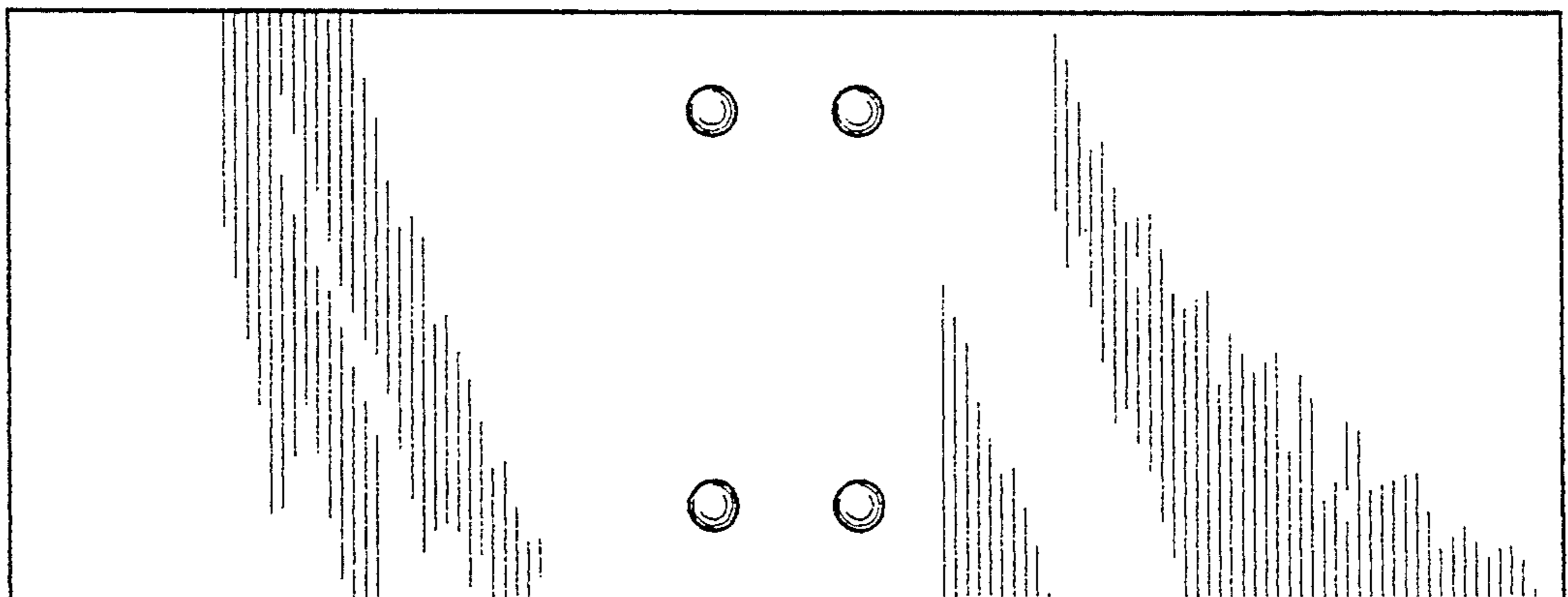

FIG. 7

