



US00D362026S

# United States Patent [19]

[11] Patent Number: **Des. 362,026**

**Garcia**

[45] Date of Patent: **\*\* Sep. 5, 1995**

[54] **BASEBALL GAME**

[76] Inventor: **Frank G. Garcia**, 736 McNamara Ave., Crescent City, Calif. 95531

[\*\*] Term: **14 Years**

[21] Appl. No.: **16,857**

[22] Filed: **Dec. 28, 1993**

[52] U.S. Cl. .... **D21/9; D21/11**

[58] Field of Search ..... **D21/9, 7, 8, 11, 14, D21/199, 16, 17, 18; 273/85 R, 88, 91, 93 C, 118 R, 123 R**

3,105,688 10/1963 Gray .  
 3,709,494 1/1973 Barlow ..... 273/89  
 4,017,074 4/1977 Roberts ..... 273/89  
 4,948,135 8/1990 Follety, Jr. .... 273/88 X  
 4,976,434 12/1990 Wikner ..... 273/89 X

*Primary Examiner*—Prabhakar G. Deshmukh  
*Attorney, Agent, or Firm*—Terry M. Gernstein

### [57] CLAIM

The ornamental design for a baseball game, as shown and described.

### DESCRIPTION

FIG. 1 is a front, top and side perspective view of the baseball game showing my new design;  
 FIG. 2 is a side elevational view thereof, the side opposite being a mirror image of the side shown in FIG. 2;  
 FIG. 3 is a front elevational view thereof;  
 FIG. 4 is a rear elevational view thereof;  
 FIG. 5 is a top plan view thereof; and,  
 FIG. 6 is a bottom plan view thereof.

[56] **References Cited**

**U.S. PATENT DOCUMENTS**

D. 84,465 6/1931 Colbion ..... D21/18  
 D. 227,586 7/1973 Maeda ..... D21/11  
 D. 320,415 10/1991 Wikner ..... D21/11  
 2,161,129 6/1939 Brook ..... D21/11 X  
 2,528,029 10/1950 Brown .  
 2,727,742 12/1955 Madsen .

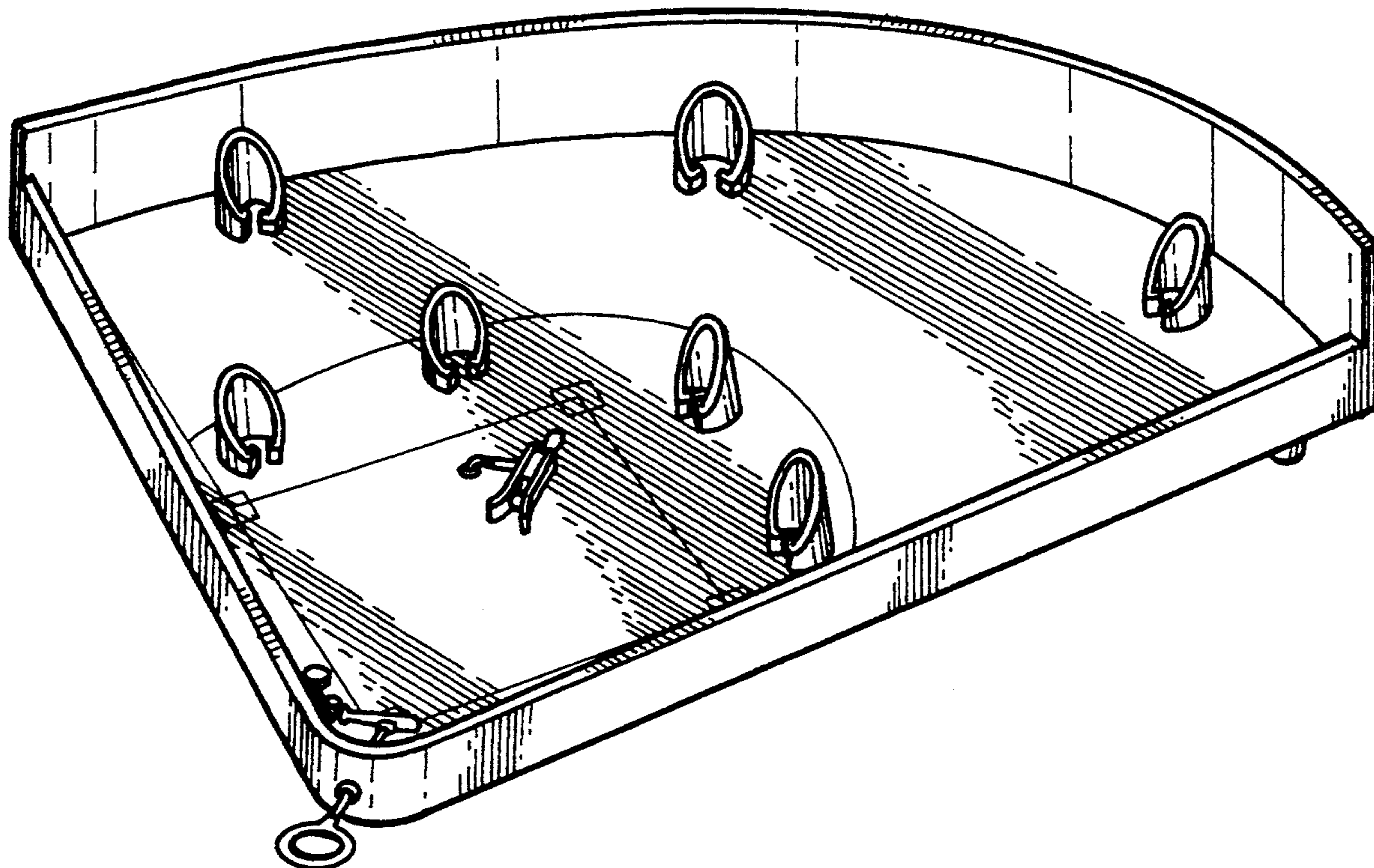

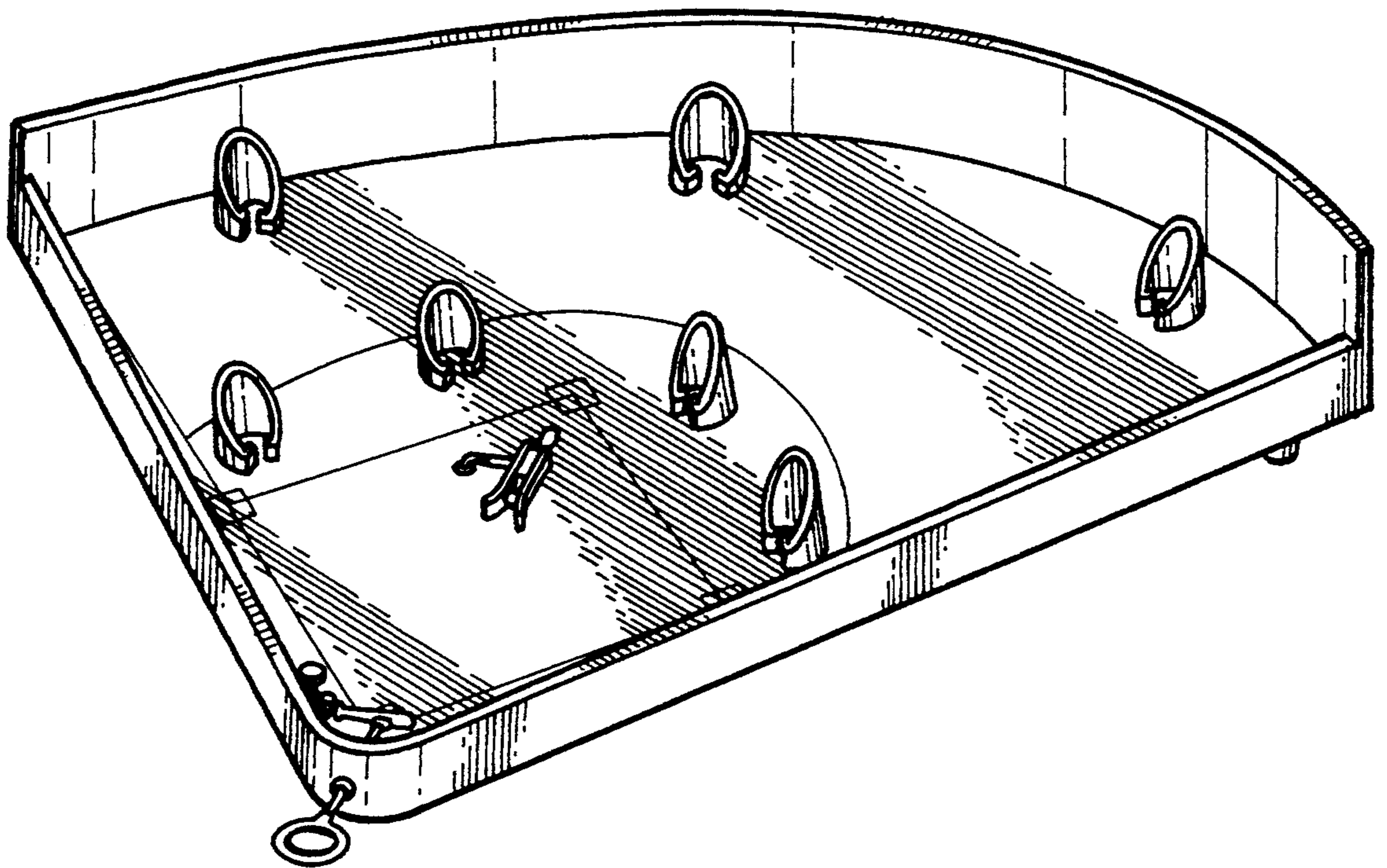

FIG. 1

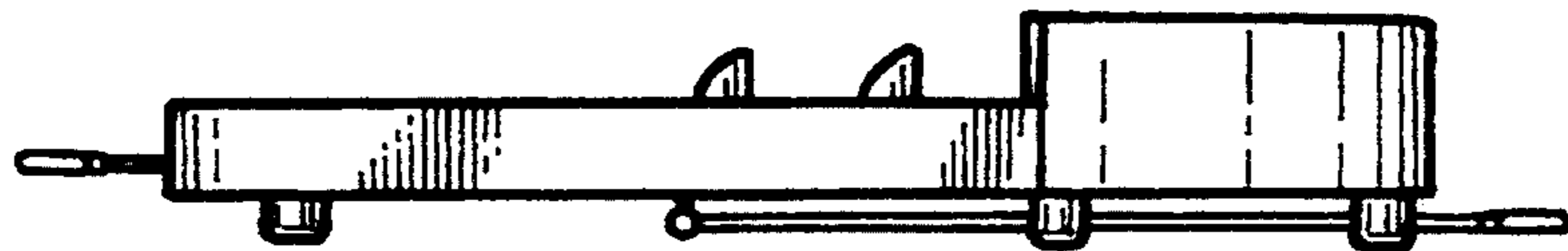

FIG. 2

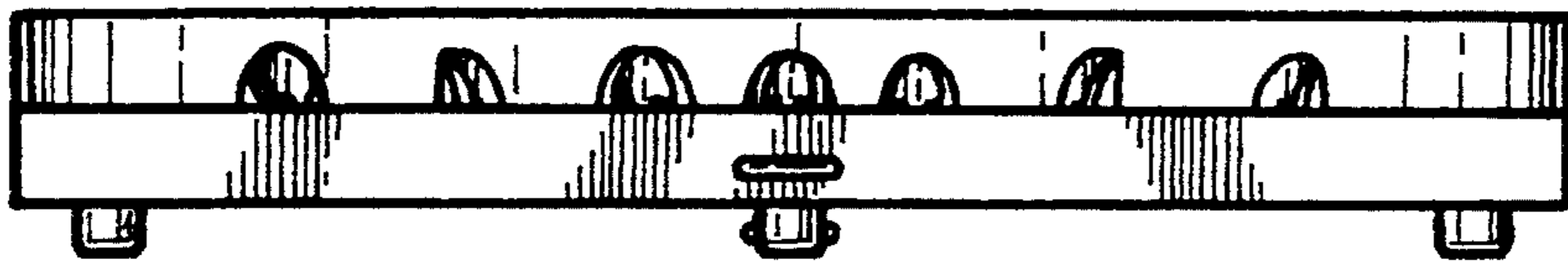

FIG. 3

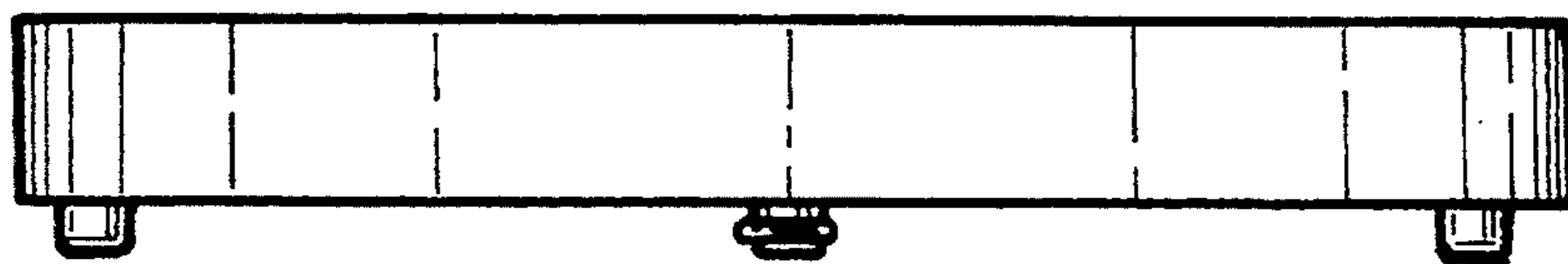

FIG. 4

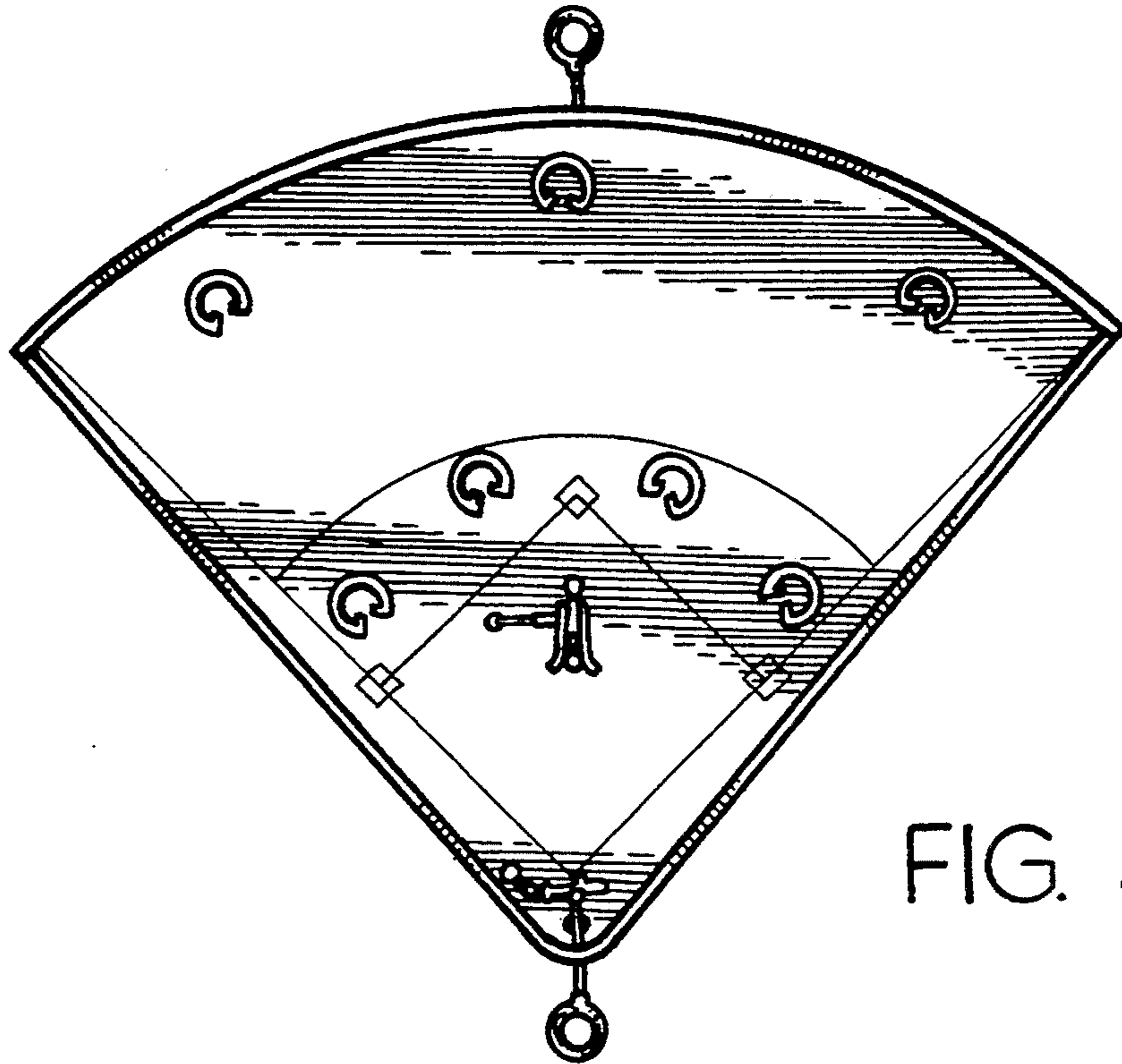

FIG. 5

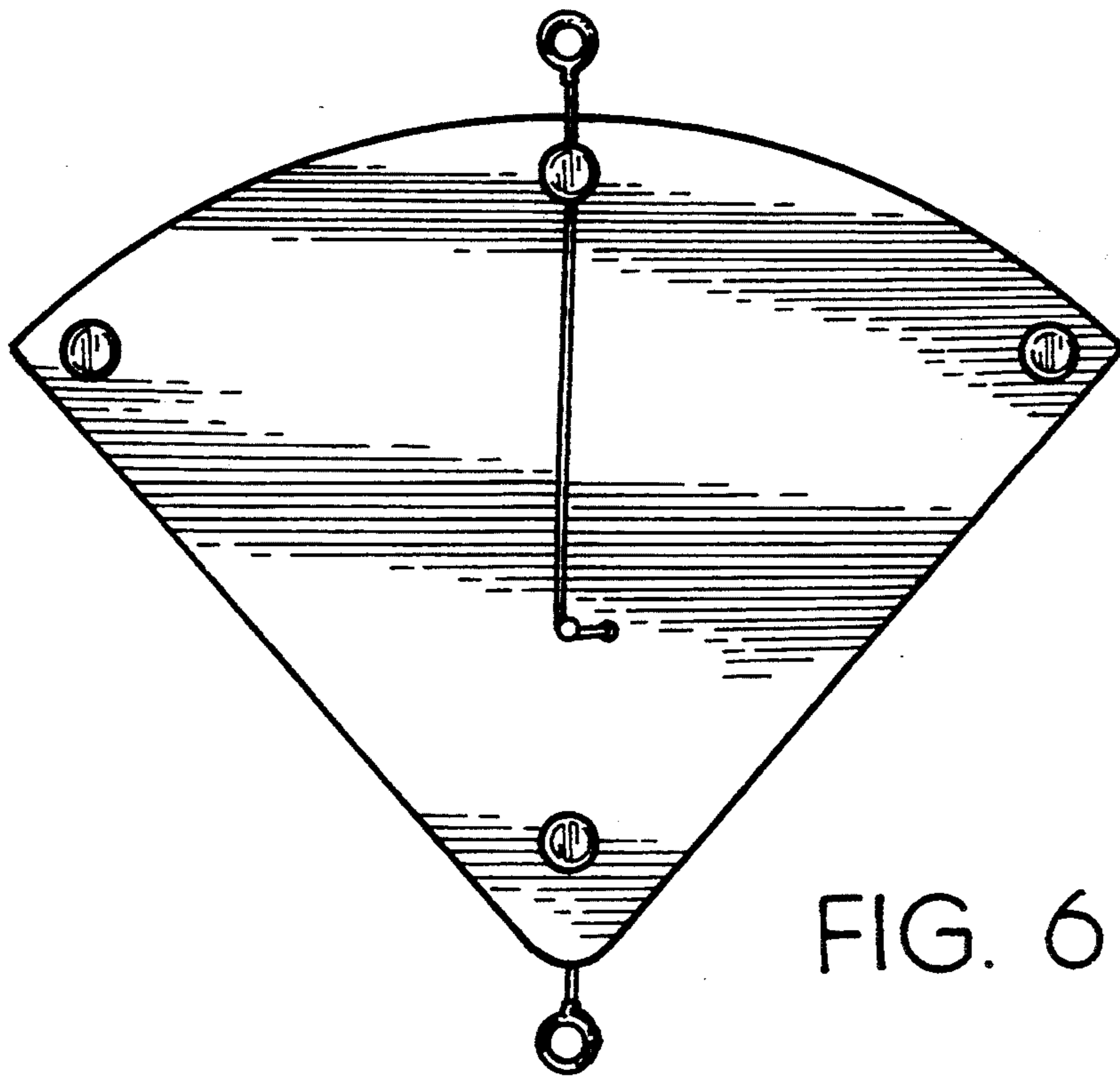

FIG. 6