



US00D361999S

United States Patent [19]

[11] Patent Number: **Des. 361,999**

Roegner

[45] Date of Patent: **** Sep. 5, 1995**

[54] **HOUSING FOR BASE OF A CORDLESS TELEPHONE**

[75] Inventor: **George P. Roegner, Vero Beach, Fla.**

[73] Assignee: **North American Foreign Trading Corporation, New York, N.Y.**

[**] Term: **14 Years**

[21] Appl. No.: **25,613**

[22] Filed: **Jul. 7, 1994**

[52] U.S. Cl. **D14/149**

[58] Field of Search **D14/137, 138, 140, 142, D14/147-151, 240, 241; 379/58-61, 433-436, 419, 420, 428, 440**

D. 334,748	4/1993	Roegner .	
D. 335,289	5/1993	Roegner .	
D. 335,494	5/1993	Roegner .	
D. 335,666	5/1993	Roegner .	
D. 335,878	5/1993	Roegner .	
D. 339,132	9/1993	Roegner .	
D. 339,133	9/1993	Roegner .	
D. 345,974	4/1994	Biskup et al.	D14/149
4,706,274	11/1987	Baker et al.	379/61

Primary Examiner—Jeffrey Asch

[57] CLAIM

The ornamental design for a housing for base of a cordless telephone, as shown and described.

DESCRIPTION

FIG. 1 is a top-front perspective view of the housing for the base of a cordless telephone, including a broken line showing of a handset in a cradled position, showing my new design;

FIG. 2 is a front elevational view of the housing for the base of a cordless telephone of FIG. 1;

FIG. 3 is a top elevational view thereof;

FIG. 4 is a bottom elevational view thereof;

FIG. 5 is a rear elevational view thereof;

FIG. 6 is a right side elevational view thereof; and,

FIG. 7 is a left side elevational view thereof.

The broken line showing of a handset in FIG. 1 is for environmental purposes only and forms no part of the claimed design.

[56] References Cited

U.S. PATENT DOCUMENTS

D. 272,438	1/1984	Coons et al.	D14/149 X
D. 274,244	6/1984	Kim	D14/138
D. 278,708	5/1985	Taylor et al.	D14/149
D. 286,282	10/1986	Asaki	D14/138
D. 287,010	12/1986	Sekiguchi et al.	D14/148 X
D. 287,851	1/1987	Hoi	D14/151
D. 287,971	1/1987	Bond	D14/138
D. 288,561	3/1987	Bond	D14/148
D. 301,874	1/1989	Roegner .	
D. 326,451	5/1992	Roegner .	
D. 326,452	5/1992	Roegner .	
D. 334,747	4/1993	Roegner .	

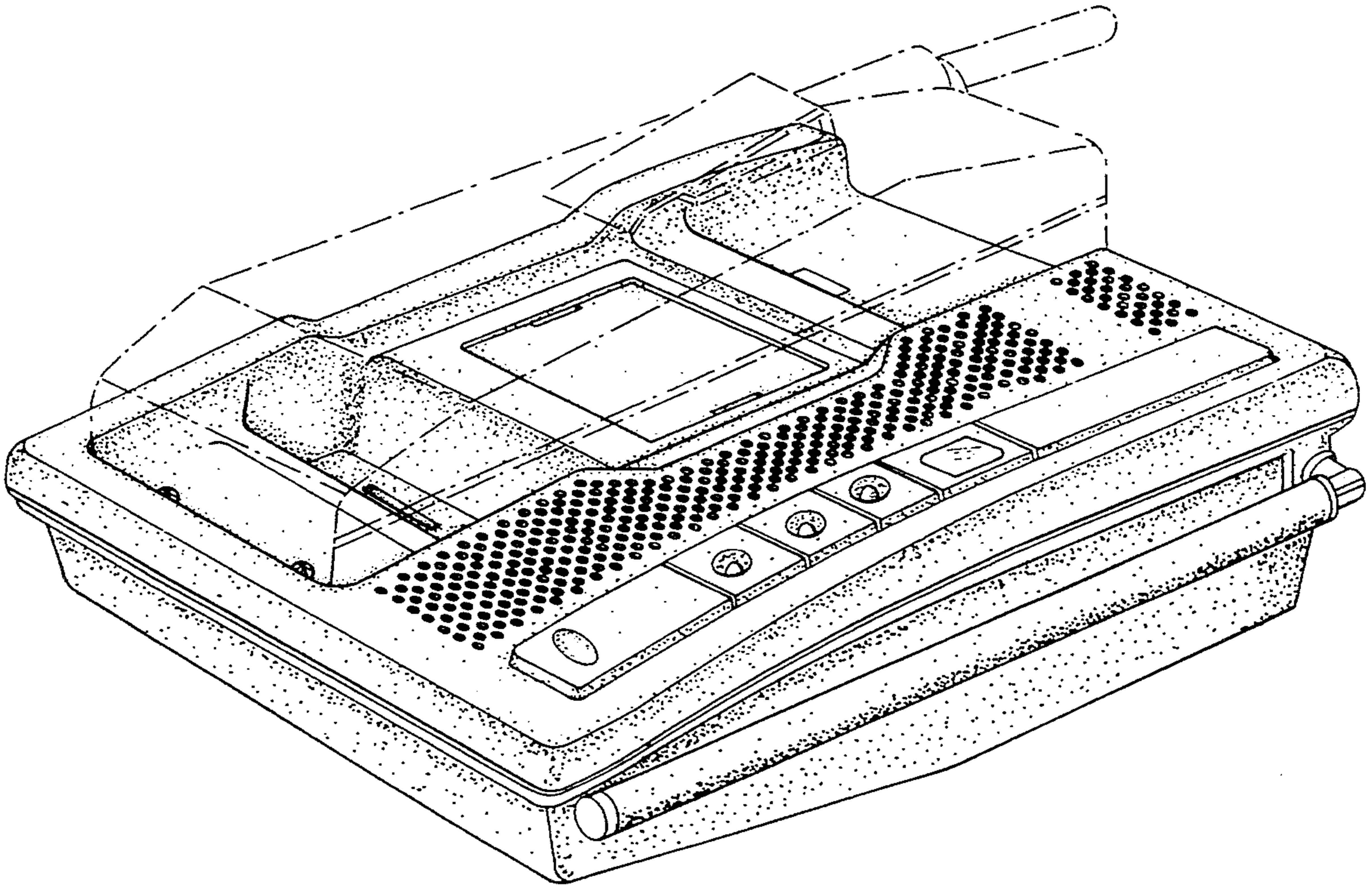

FIG. 1

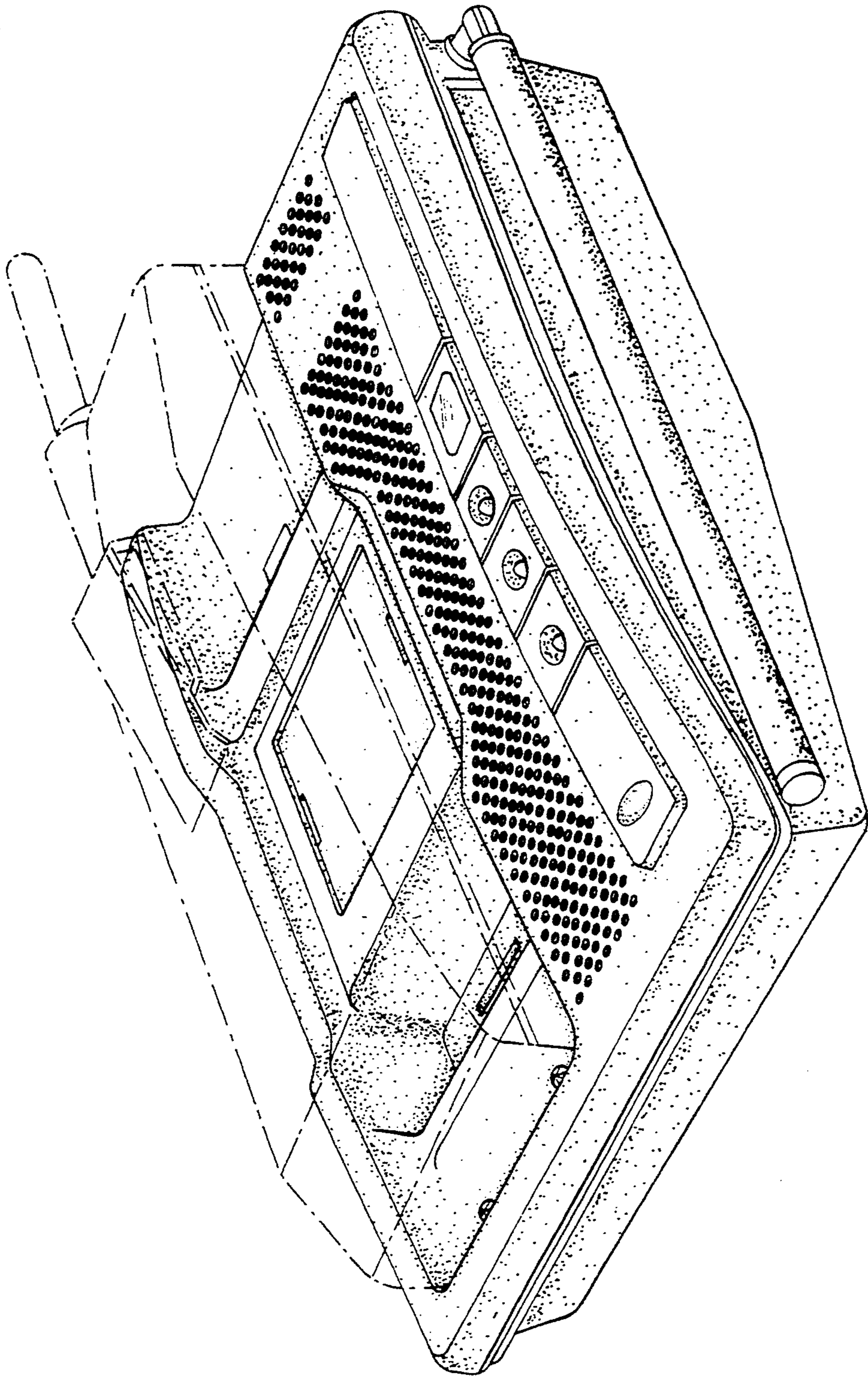

FIG. 2

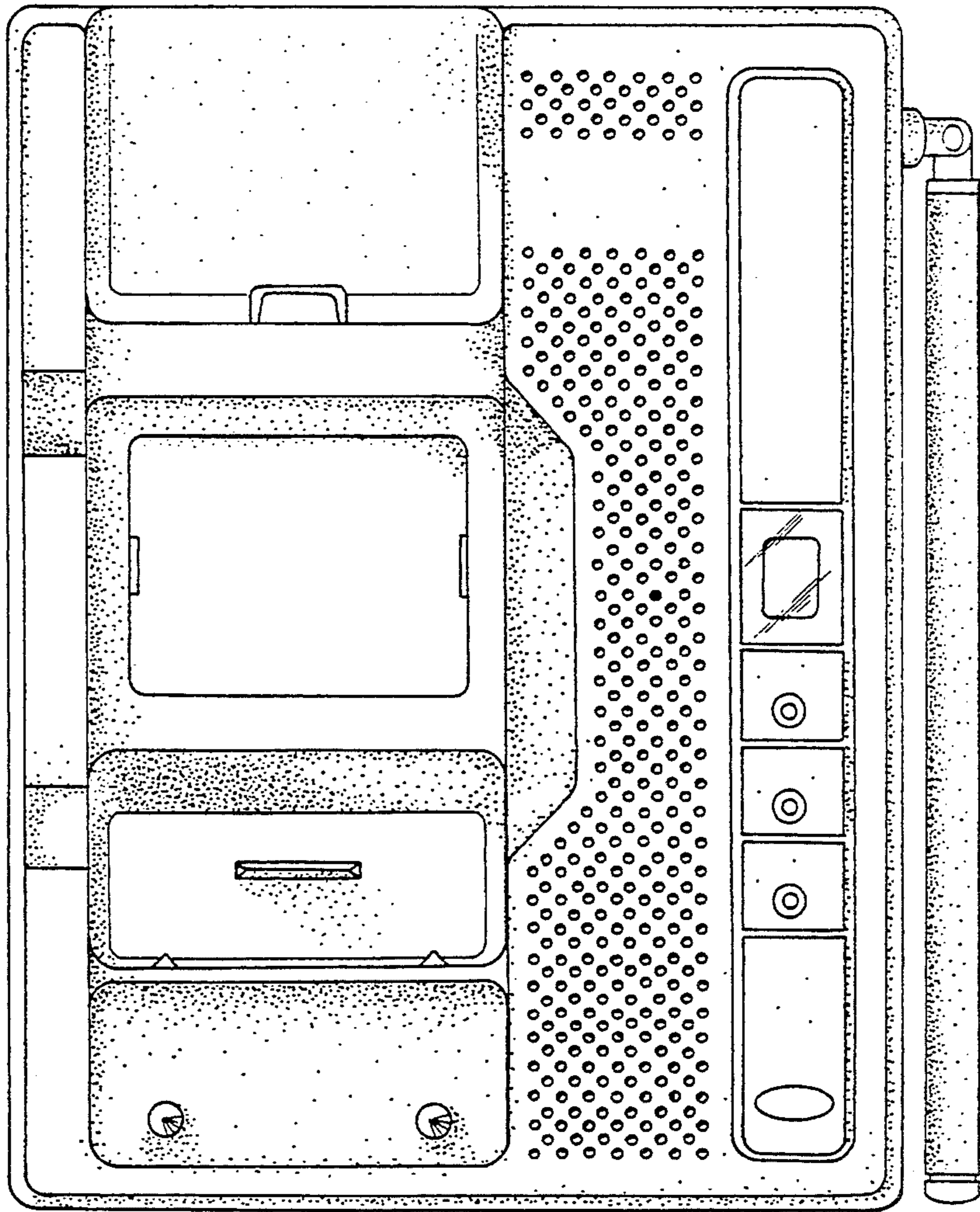

FIG. 3

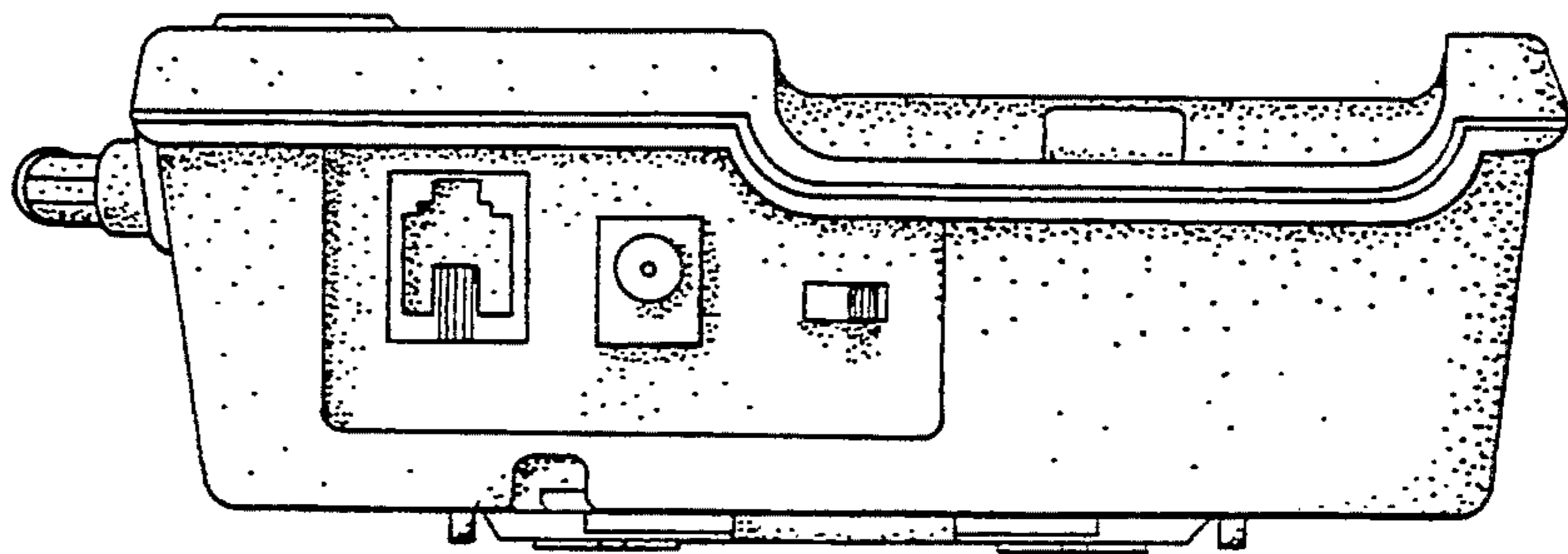

FIG. 4

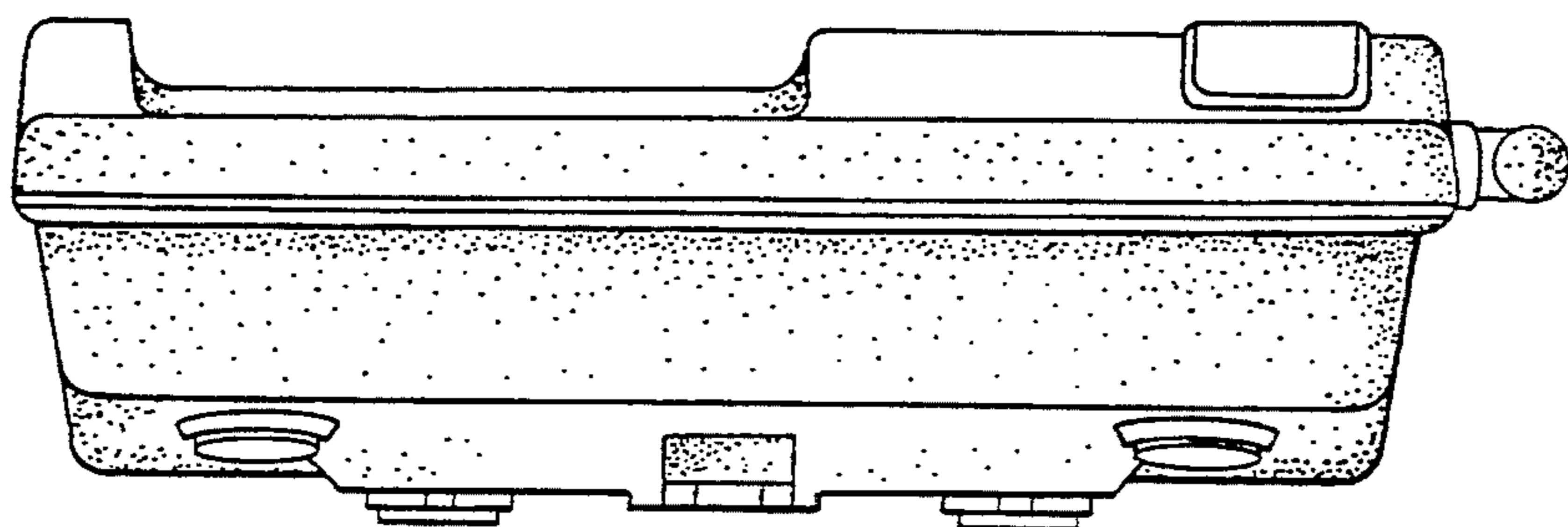

FIG. 5

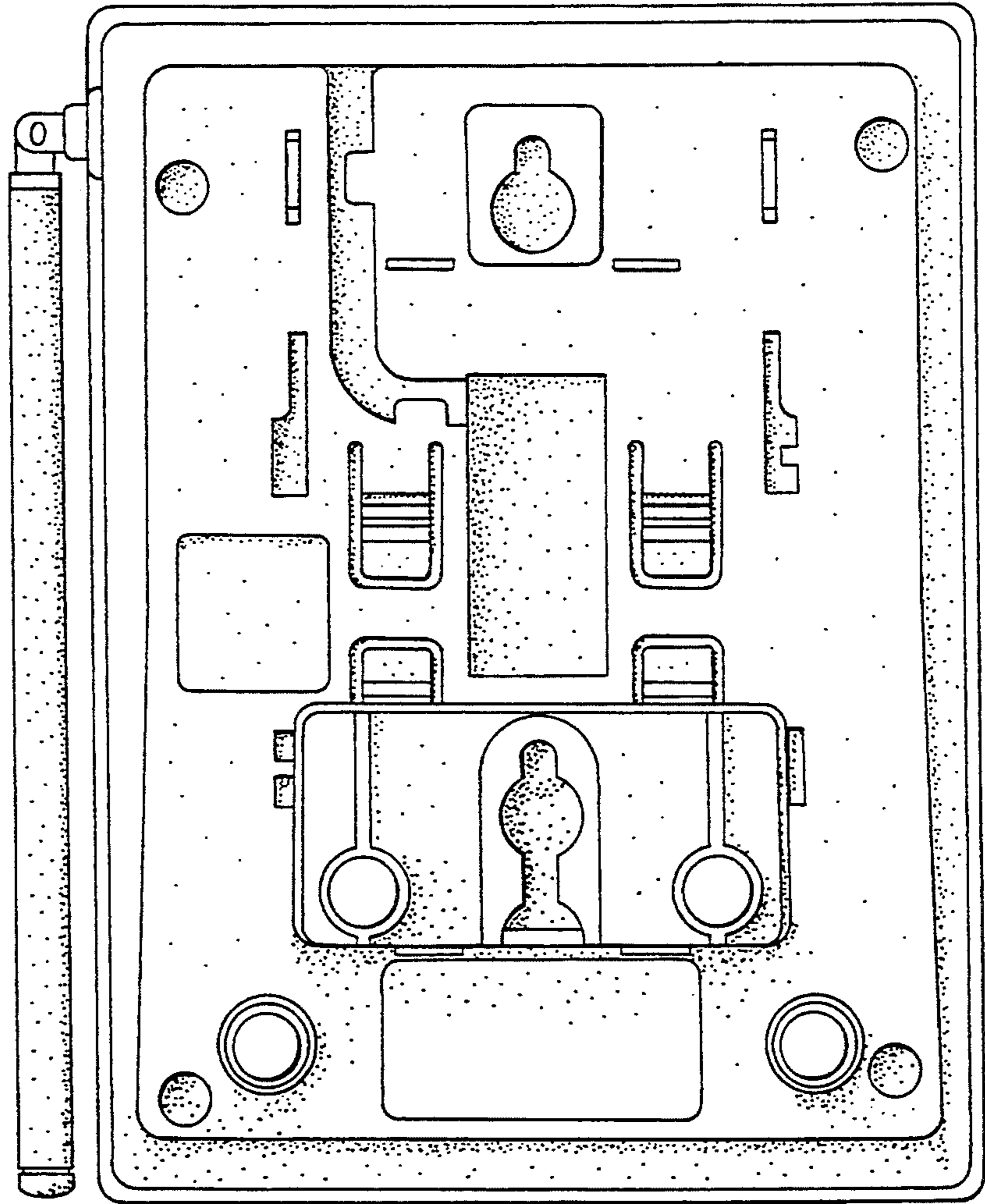

FIG. 6

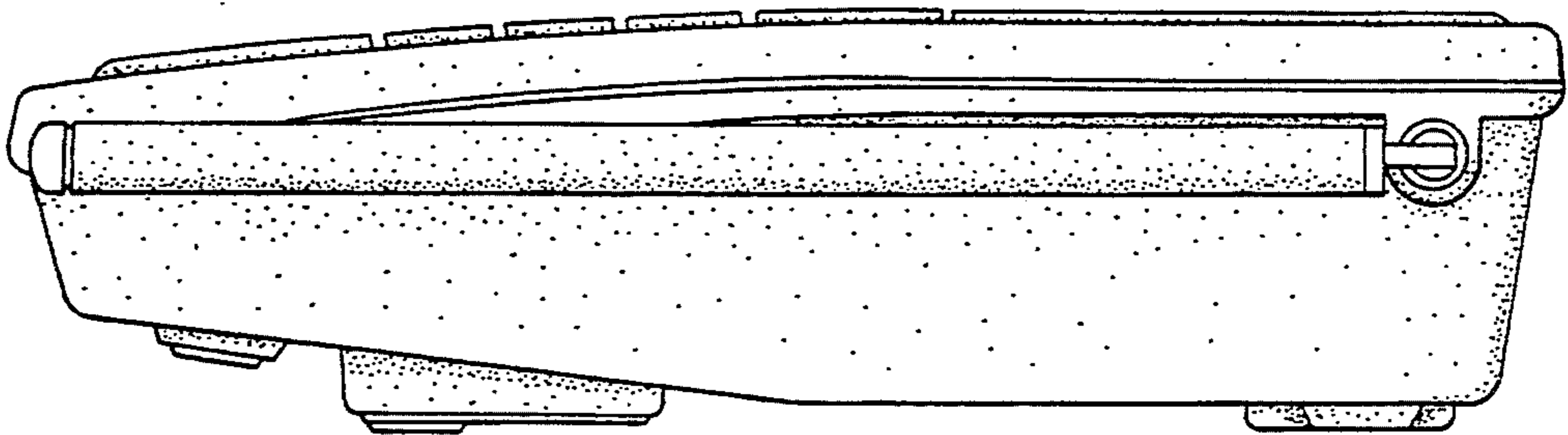

FIG. 7

