



US00D361981S

United States Patent [19]
Okamoto

[11] **Patent Number: Des. 361,981**
[45] **Date of Patent: ** Sep. 5, 1995**

- [54] **ATTACHMENT PLUG**
- [75] **Inventor: Isao Okamoto, Osaka, Japan**
- [73] **Assignee: Nichido Kogyo Kabushiki Kaisha, Osaka, Japan**
- [**] **Term: 14 Years**
- [21] **Appl. No.: 29,947**
- [22] **Filed: Oct. 19, 1994**
- [30] **Foreign Application Priority Data**
Oct. 3, 1994 [JP] Japan 6-30157
- [52] **U.S. Cl. D13/143**
- [58] **Field of Search D13/137, 138, 141, 143, D13/146; 439/103, 104, 106, 160, 597, 600, 601, 606, 677, 678, 679, 682, 692**
- [56] **References Cited**
U.S. PATENT DOCUMENTS
D. 339,566 9/1993 Okamoto D13/138

- D. 339,567 9/1993 Okamoto D13/143
- 2,984,808 5/1961 Bender 439/104
- 5,213,516 5/1993 Okamoto 439/104

Primary Examiner—Joel Sincavage
Attorney, Agent, or Firm—Lowe, Price, Leblanc & Becker

[57] **CLAIM**

The ornamental design for an attachment plug, as shown and described.

DESCRIPTION

FIG. 1 is a front view of an attachment plug showing my new design;
FIG. 2 is a rear view thereof;
FIG. 3 is a top plan view thereof;
FIG. 4 is a bottom plan view thereof;
FIG. 5 is a left side view thereof;
FIG. 6 is a right side view thereof;
FIG. 7 is a cross-sectional view taken along line 7—7 of FIG. 1 omitting internal structure; and,
FIG. 8 is a front perspective view thereof.

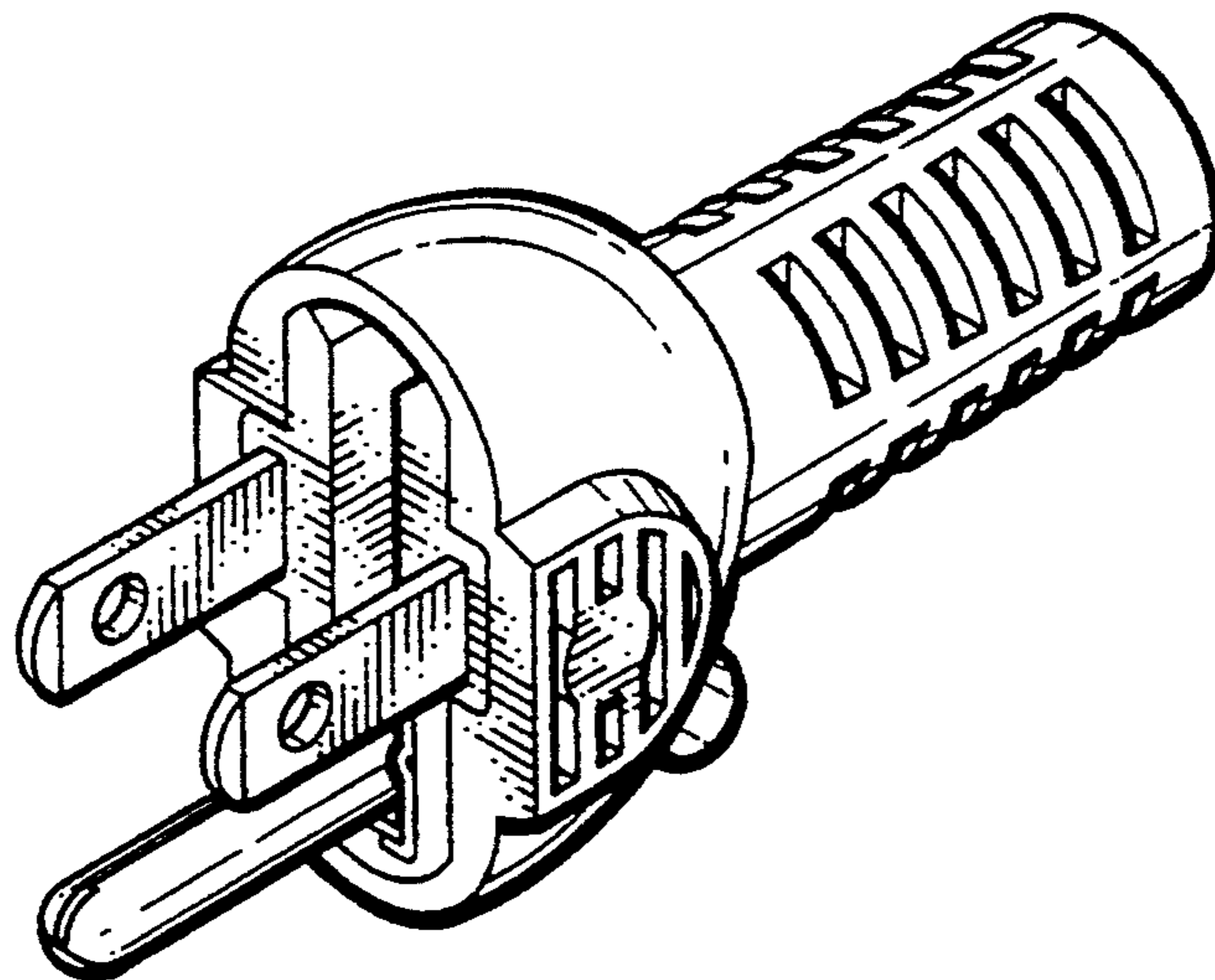

FIG. 1

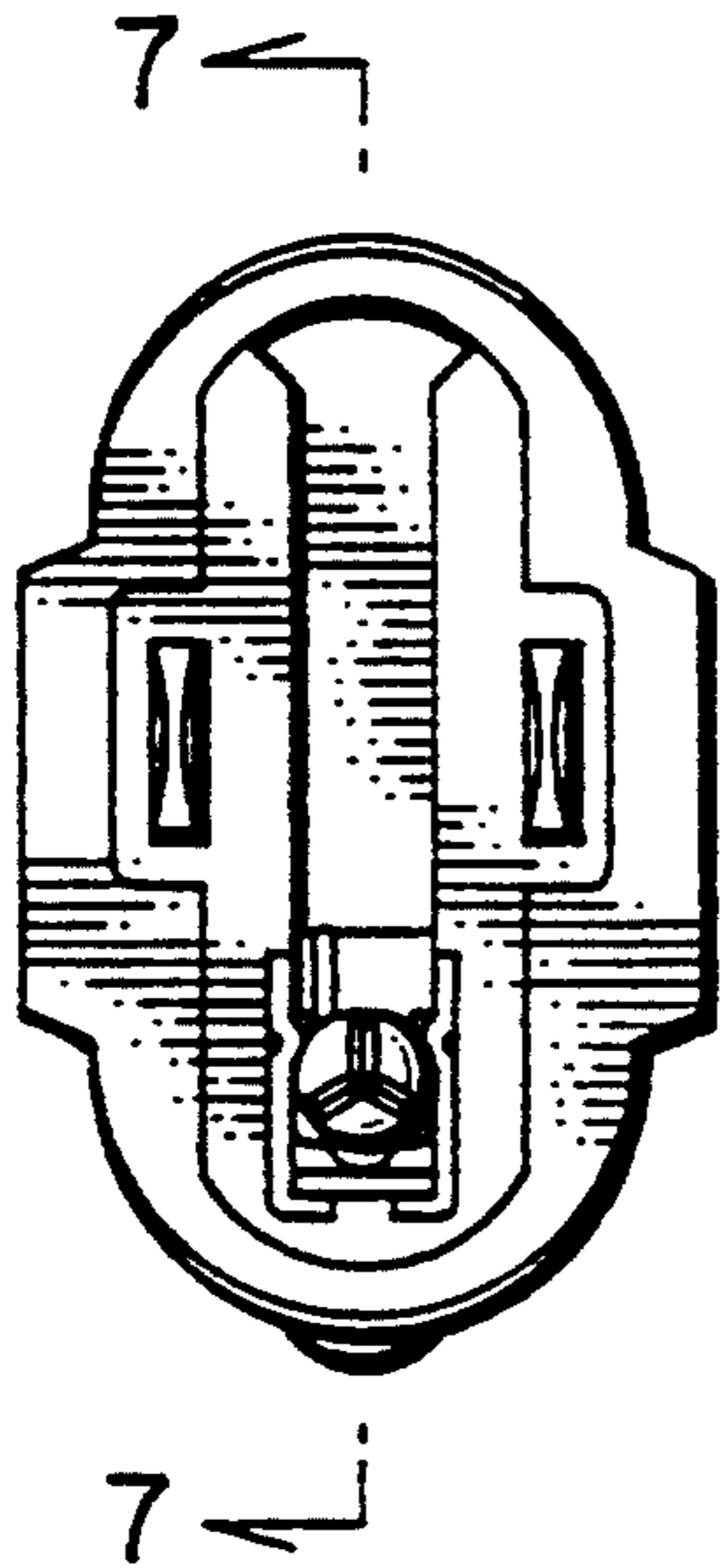

FIG. 2

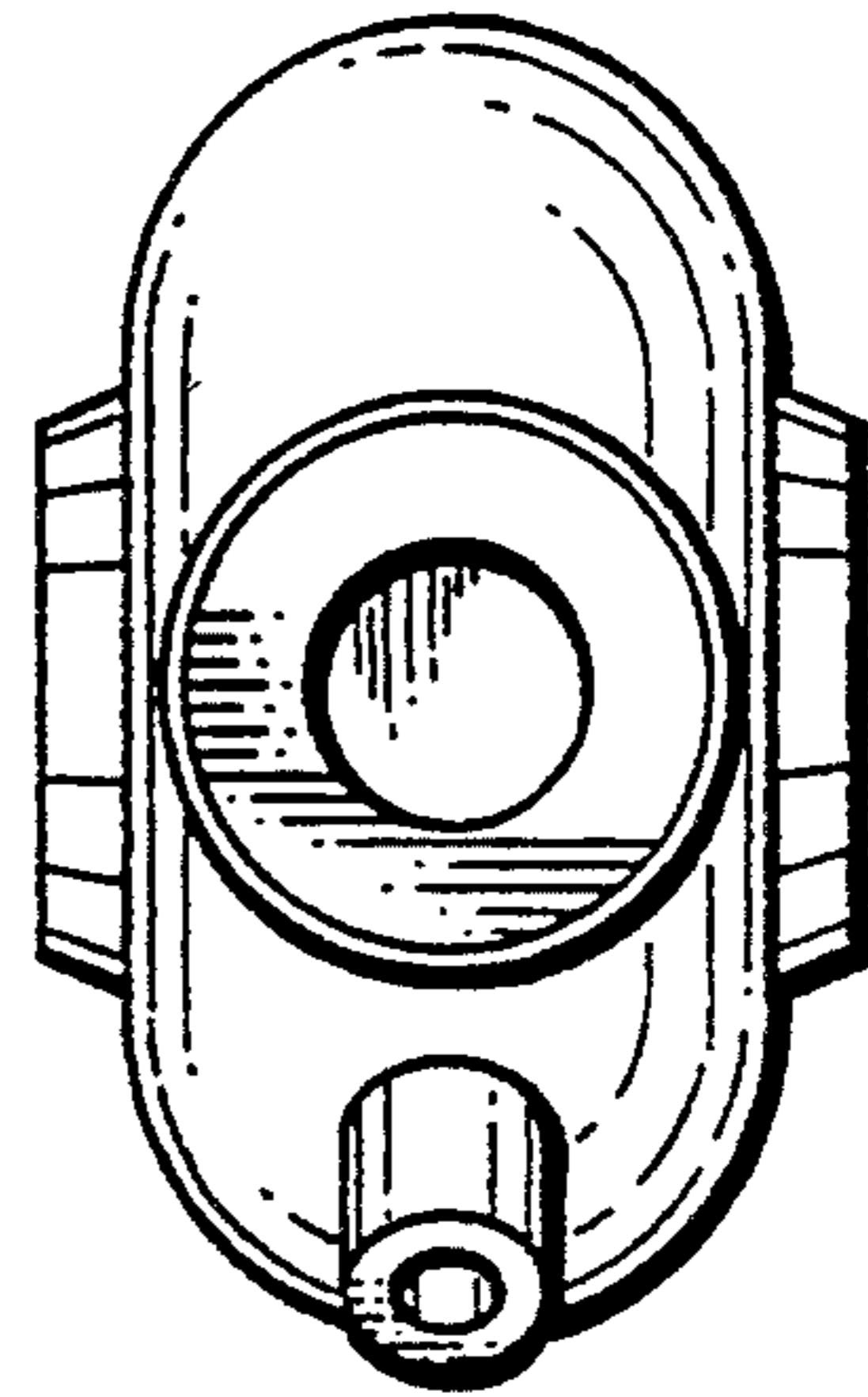

FIG. 3

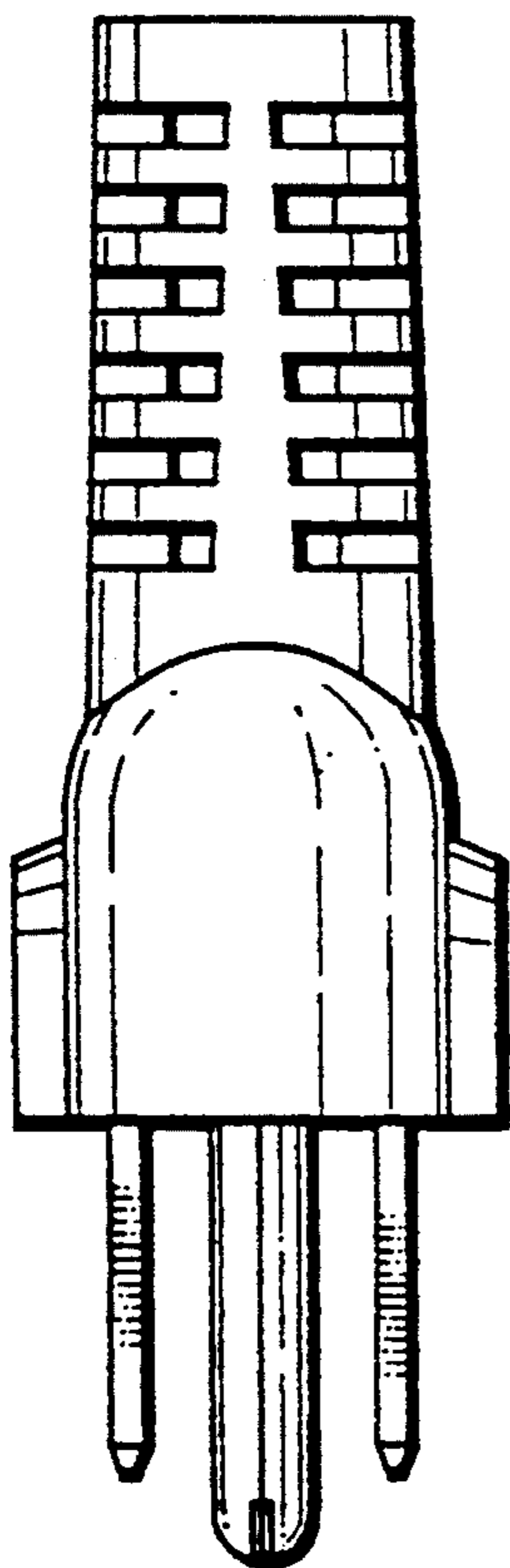

FIG. 4

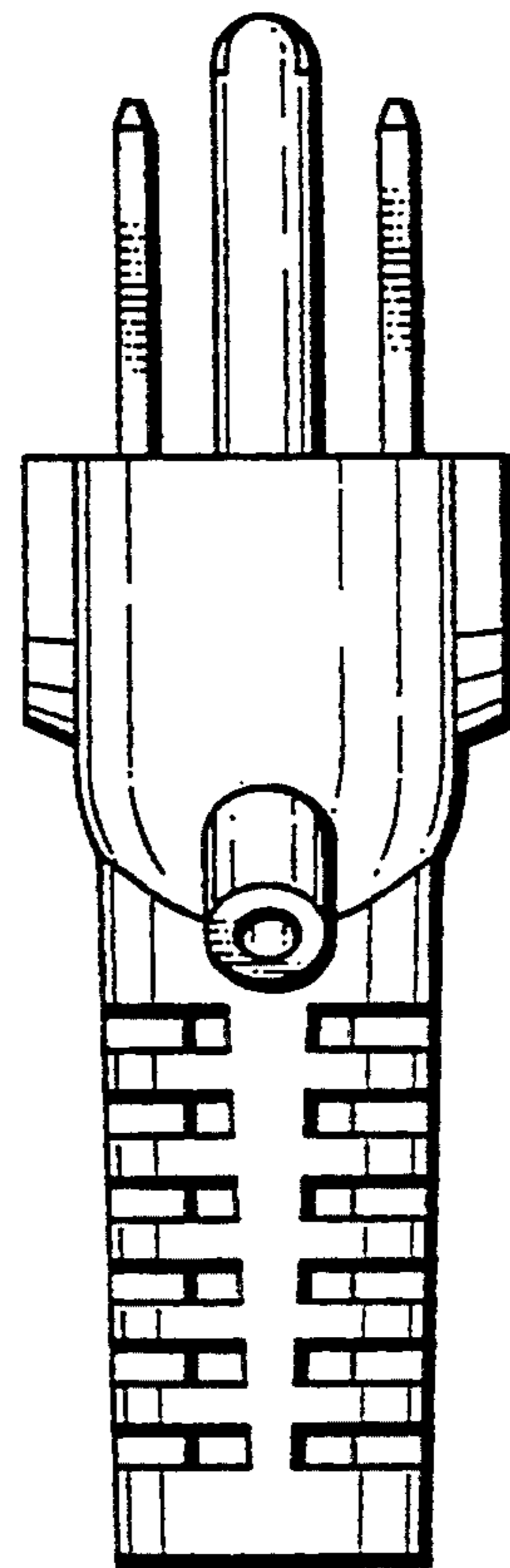

FIG. 5

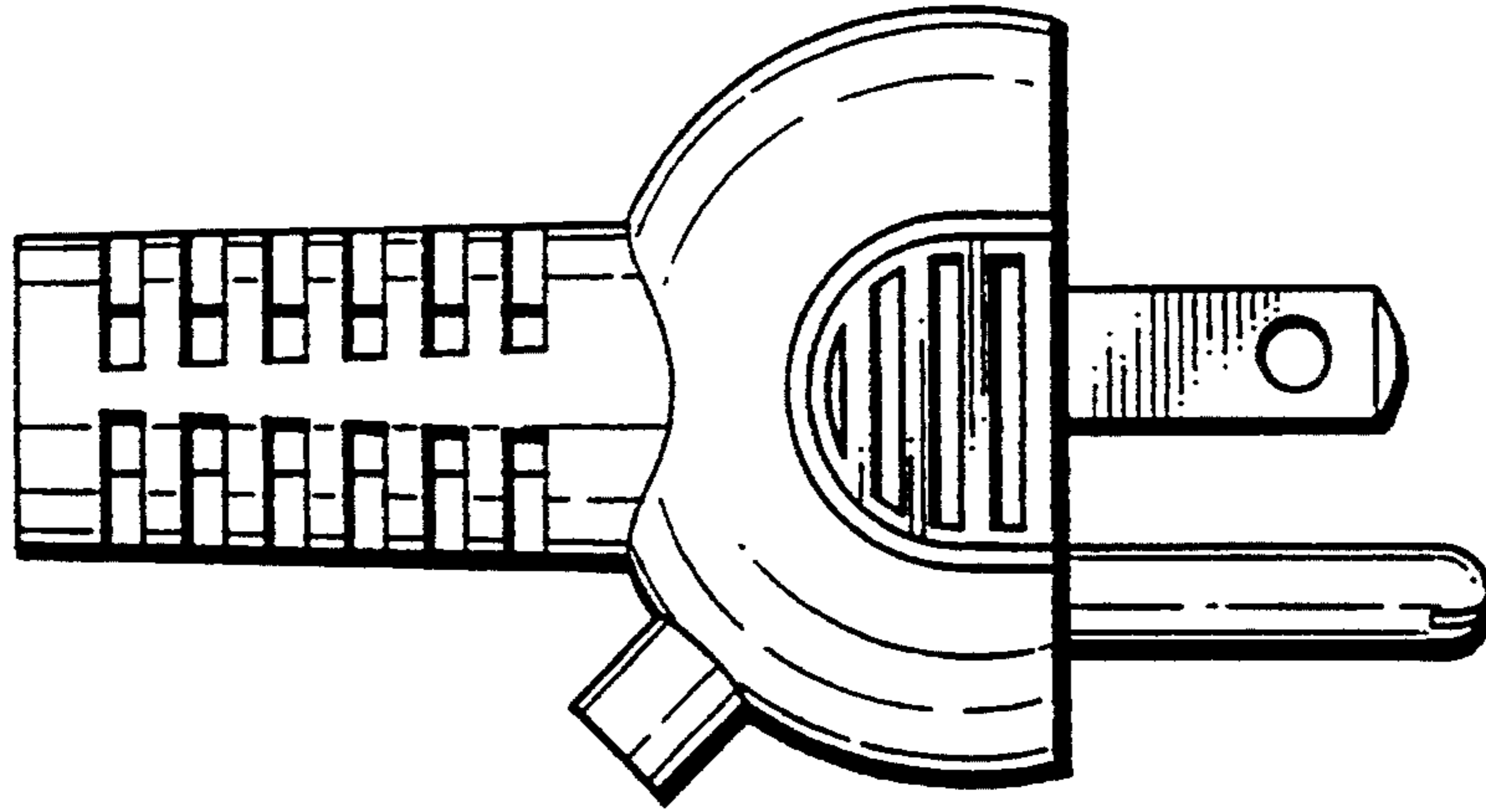

FIG. 6

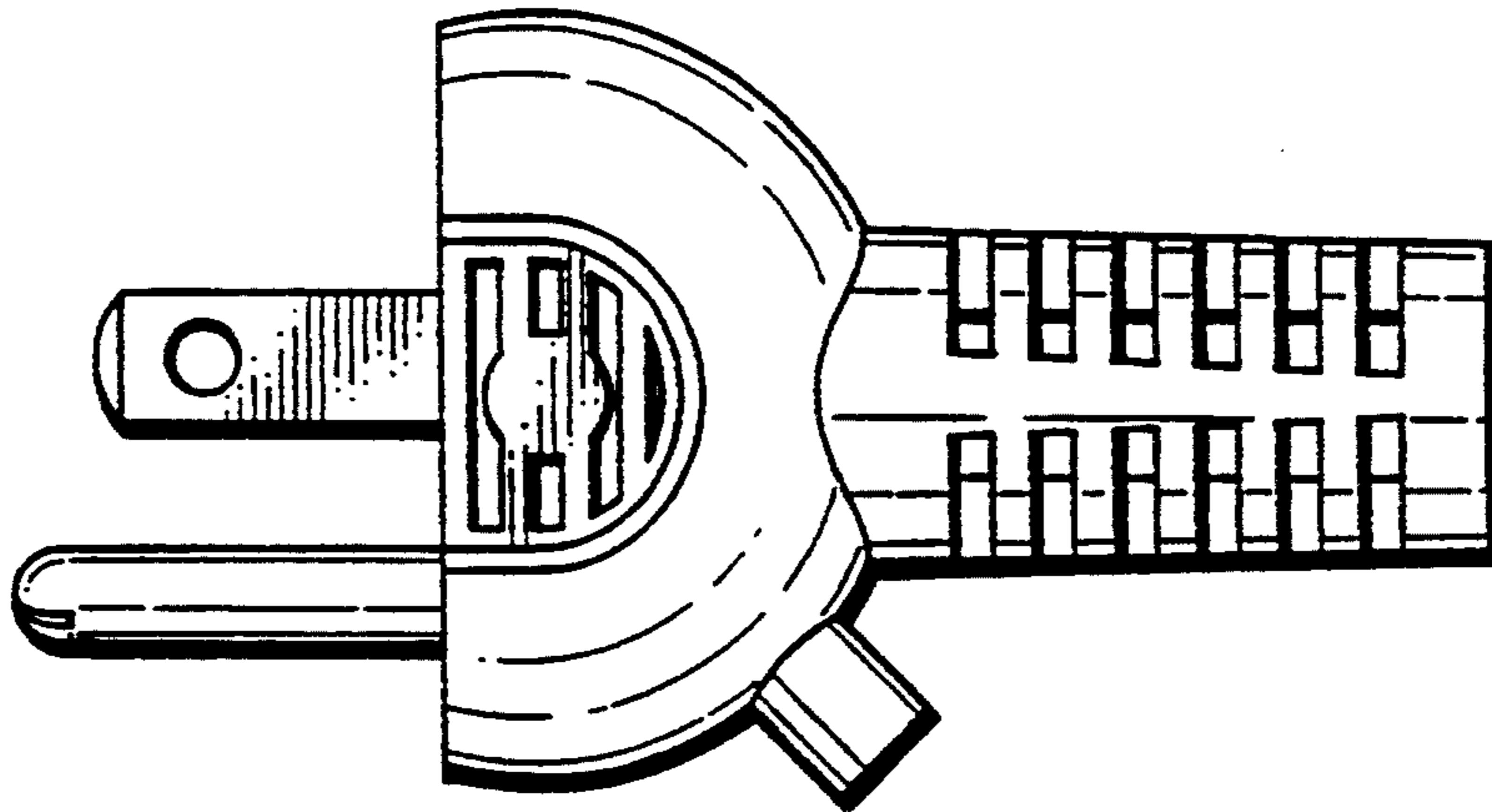

FIG. 7

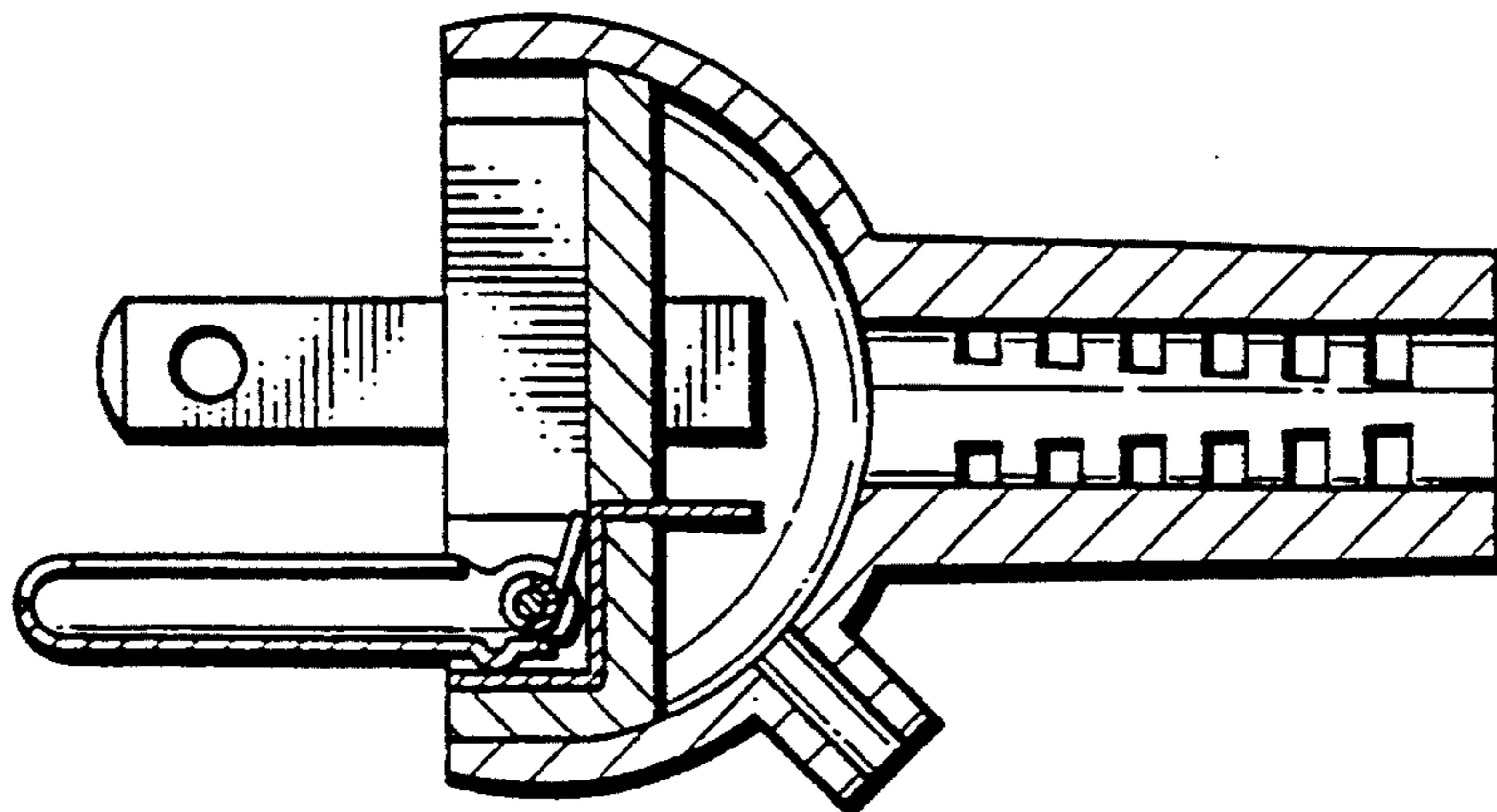

FIG. 8

