



US00D361784S

United States Patent [19]

[11] Patent Number: **Des. 361,784**

Saddler et al.

[45] Date of Patent: **** Aug. 29, 1995**

[54] **ELECTRONIC EDUCATIONAL GAME BOARD**

[56] **References Cited**

[75] Inventors: **Damon R. Saddler**, Inglewood;
Gregory B. Bergeron, La Habra, both
of Calif.

U.S. PATENT DOCUMENTS

D. 263,592	3/1982	Barbera et al.	D18/114
D. 323,860	2/1992	Cutler et al. .	
D. 331,571	12/1992	Mizusugi et al.	D14/106
D. 331,747	12/1992	Takahashi	D14/106
5,122,062	6/1992	Cutler et al. .	

[73] Assignee: **Educational Insights, Inc.**,
Dominguez Hills, Calif.

Primary Examiner—A. Hugo Word
Assistant Examiner—Pamela Burgess
Attorney, Agent, or Firm—Price, Gess & Ubell

[**] Term: **14 Years**

[57] CLAIM

The ornamental design for an electronic educational game board, as shown and described.

[21] Appl. No.: **34,250**

DESCRIPTION

[22] Filed: **Jan. 31, 1995**

FIG. 1 is a front elevational view of an electronic game board showing our new design;
FIG. 2 is a left side elevational view thereof;
FIG. 3 is a right side elevational view thereof;
FIG. 4 is a rear elevational view thereof;
FIG. 5 is a top plan view thereof;
FIG. 6 is a bottom plan view thereof; and,
FIG. 7 is a rear perspective view thereof.

[52] U.S. Cl. **D19/64; D19/60;**
D21/13

[58] Field of Search D19/59-64;
D21/13; D14/100, 106; D18/11; 434/128, 169,
322, 323, 324, 327, 335

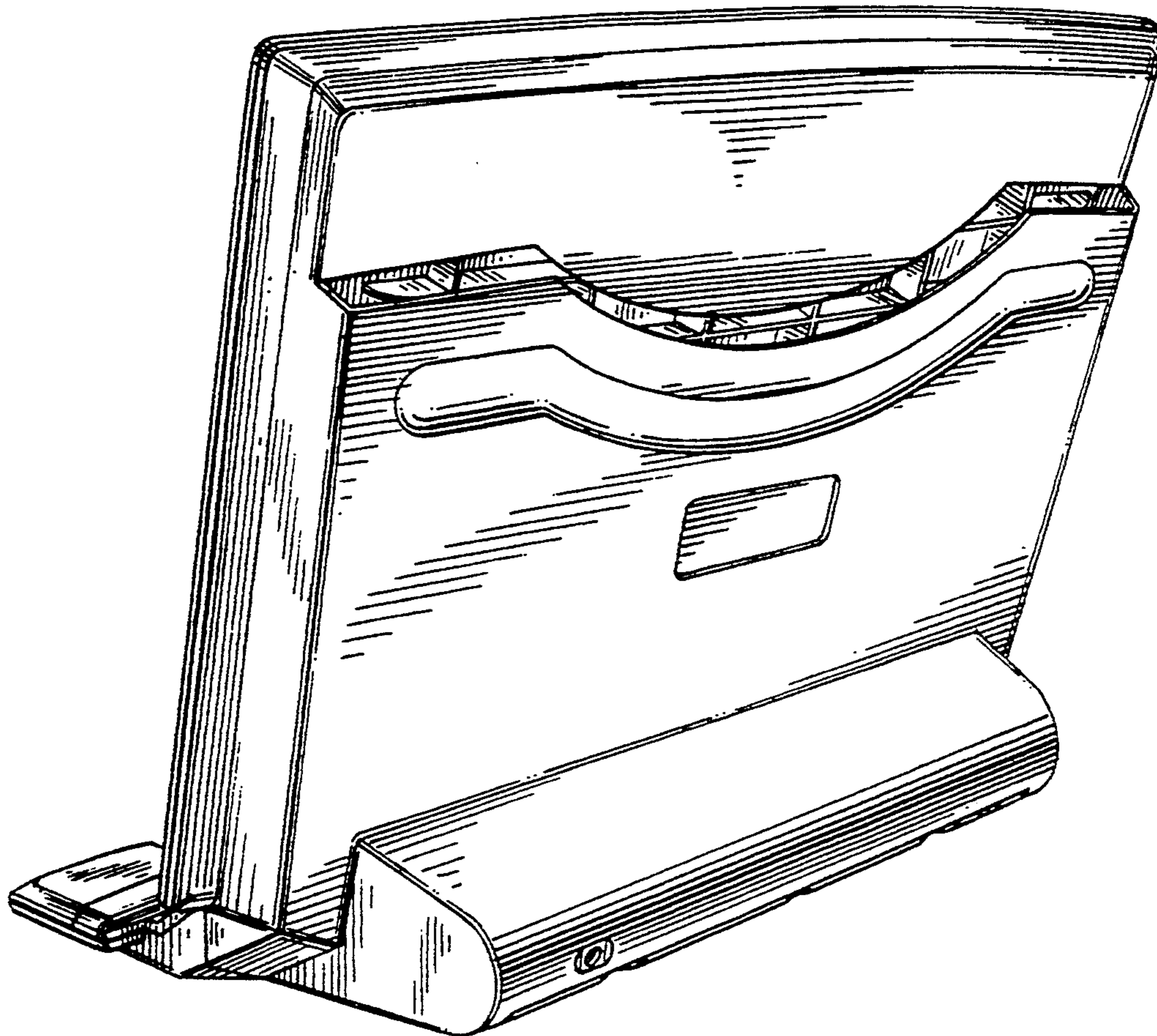

FIG. 1

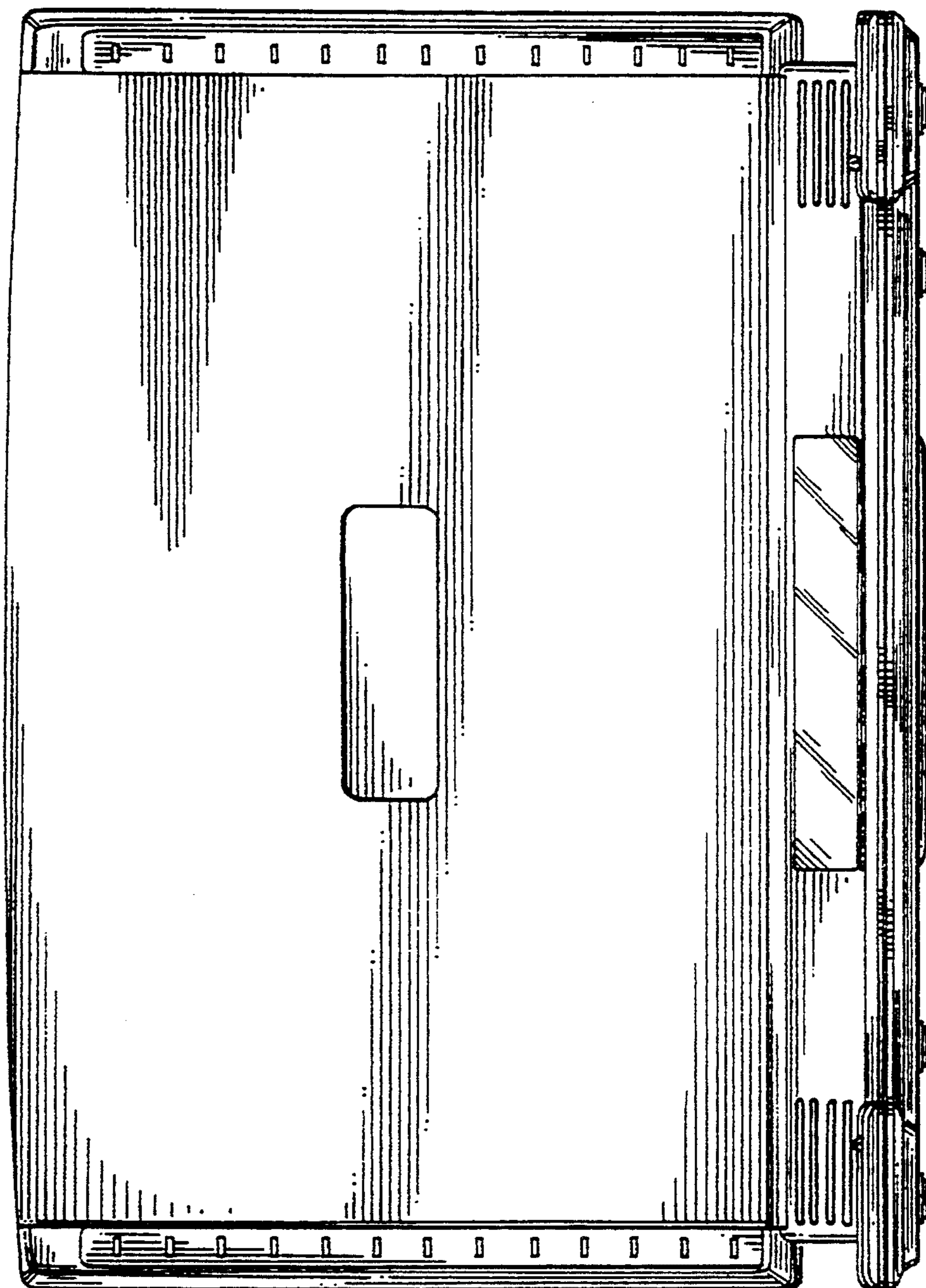

FIG. 2

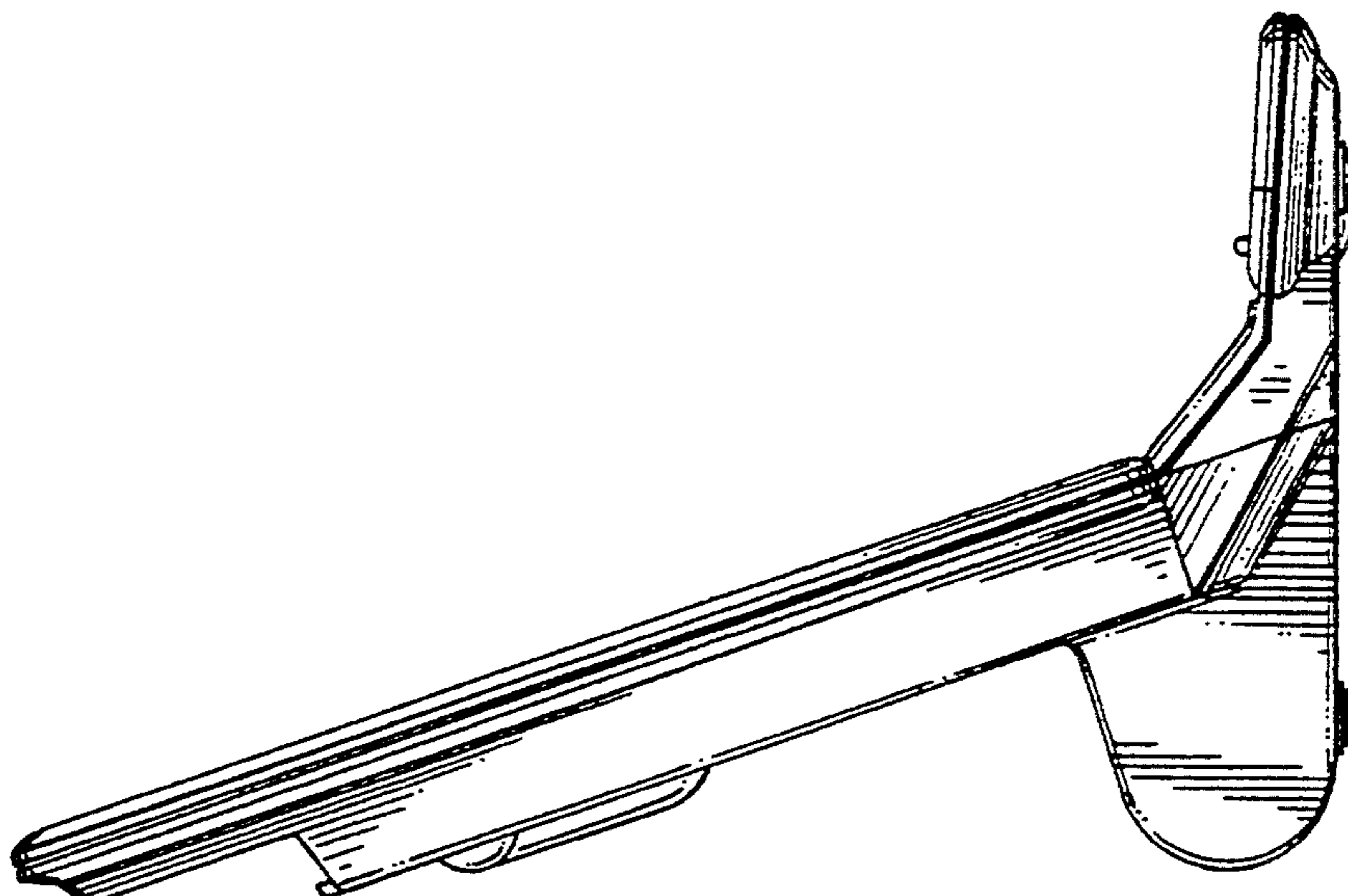

FIG. 4

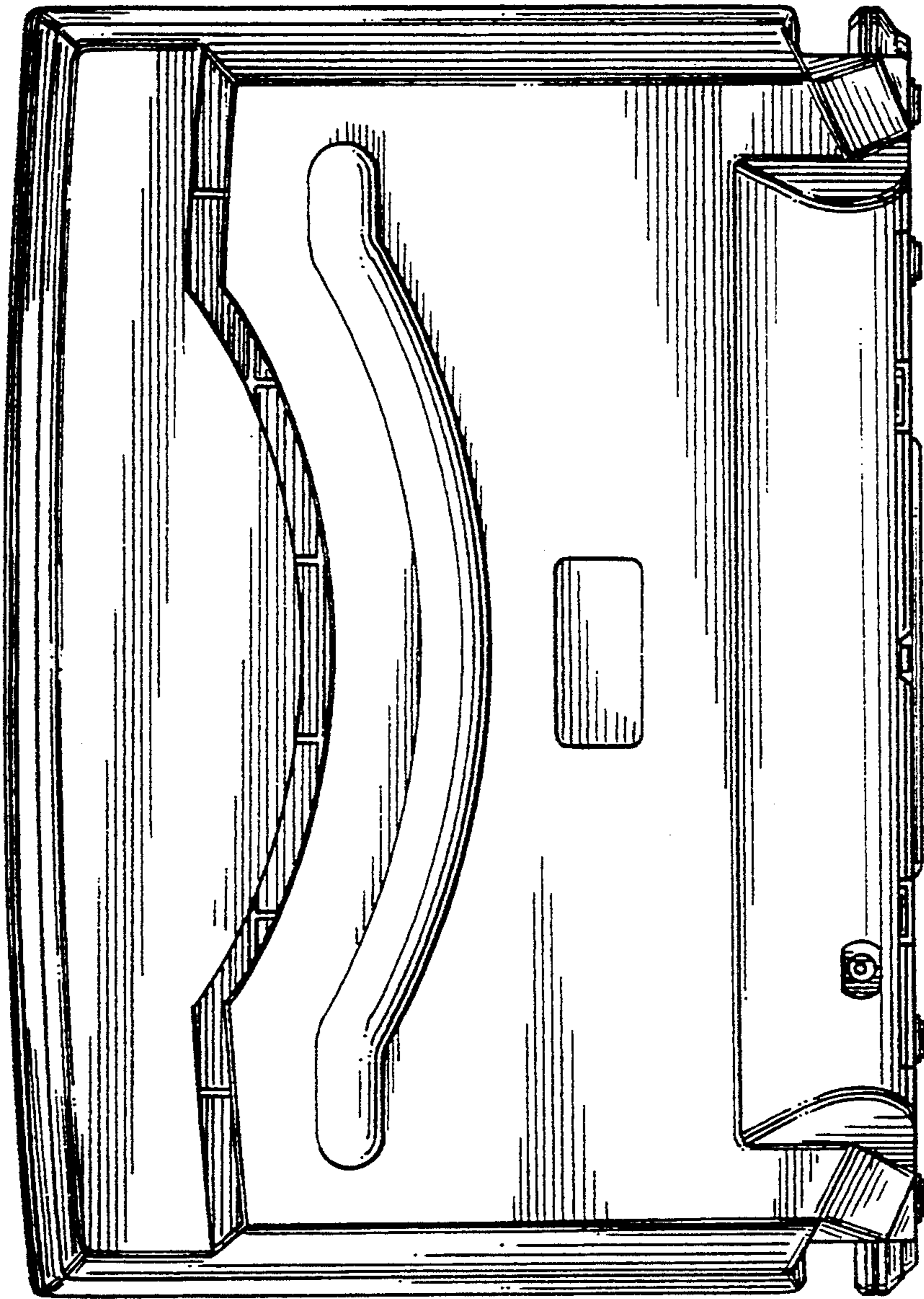
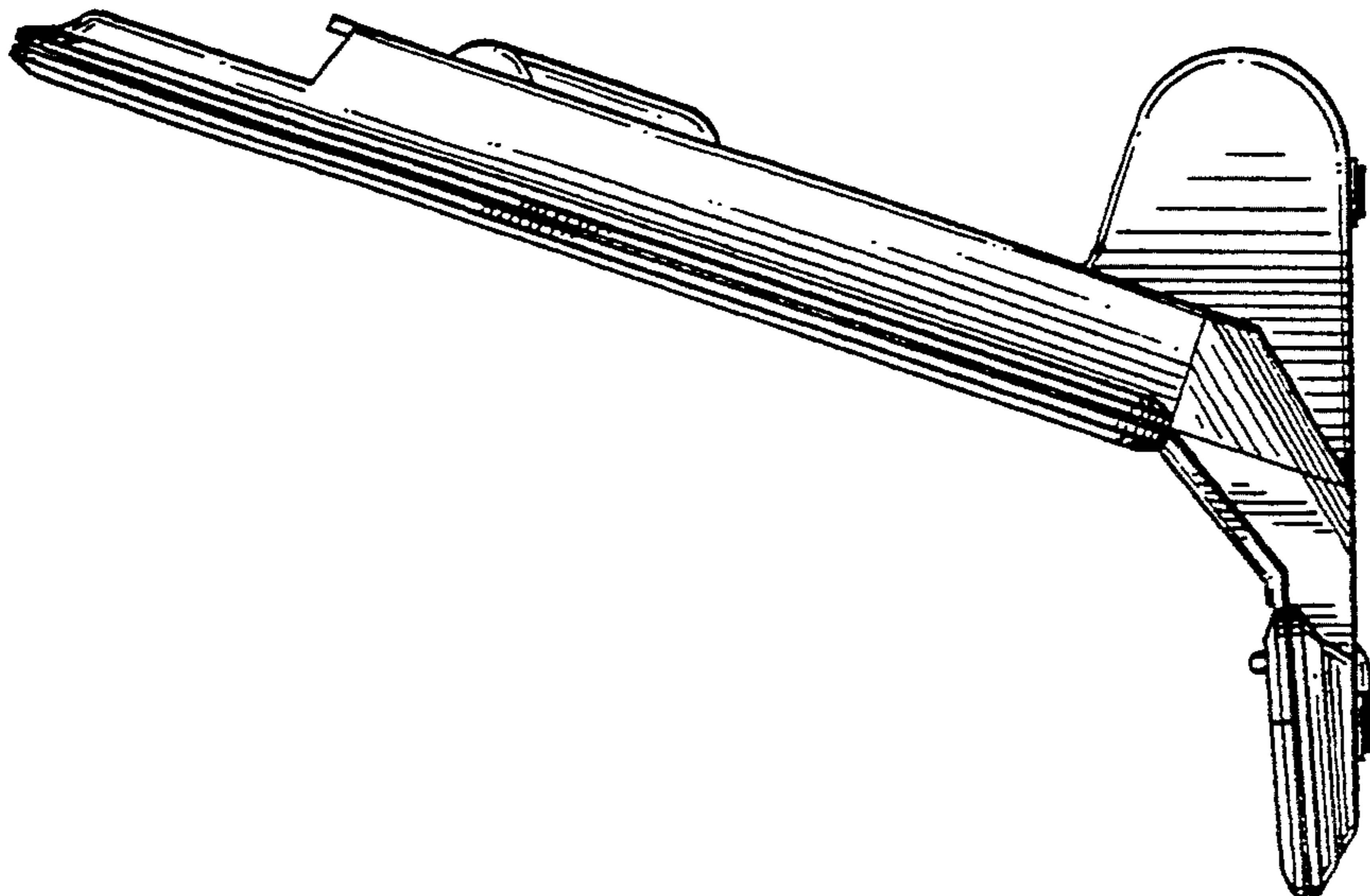

FIG. 3



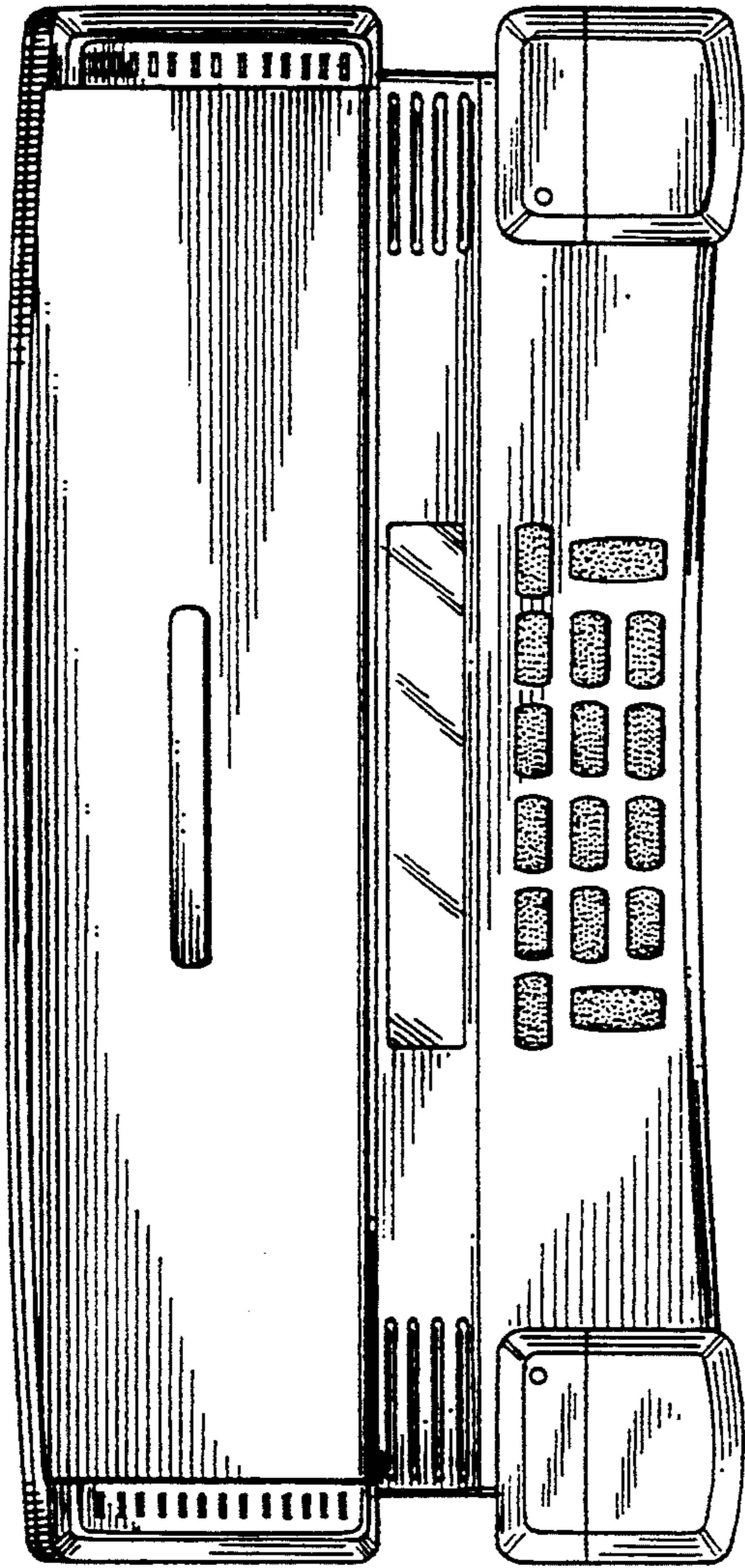

FIG. 5

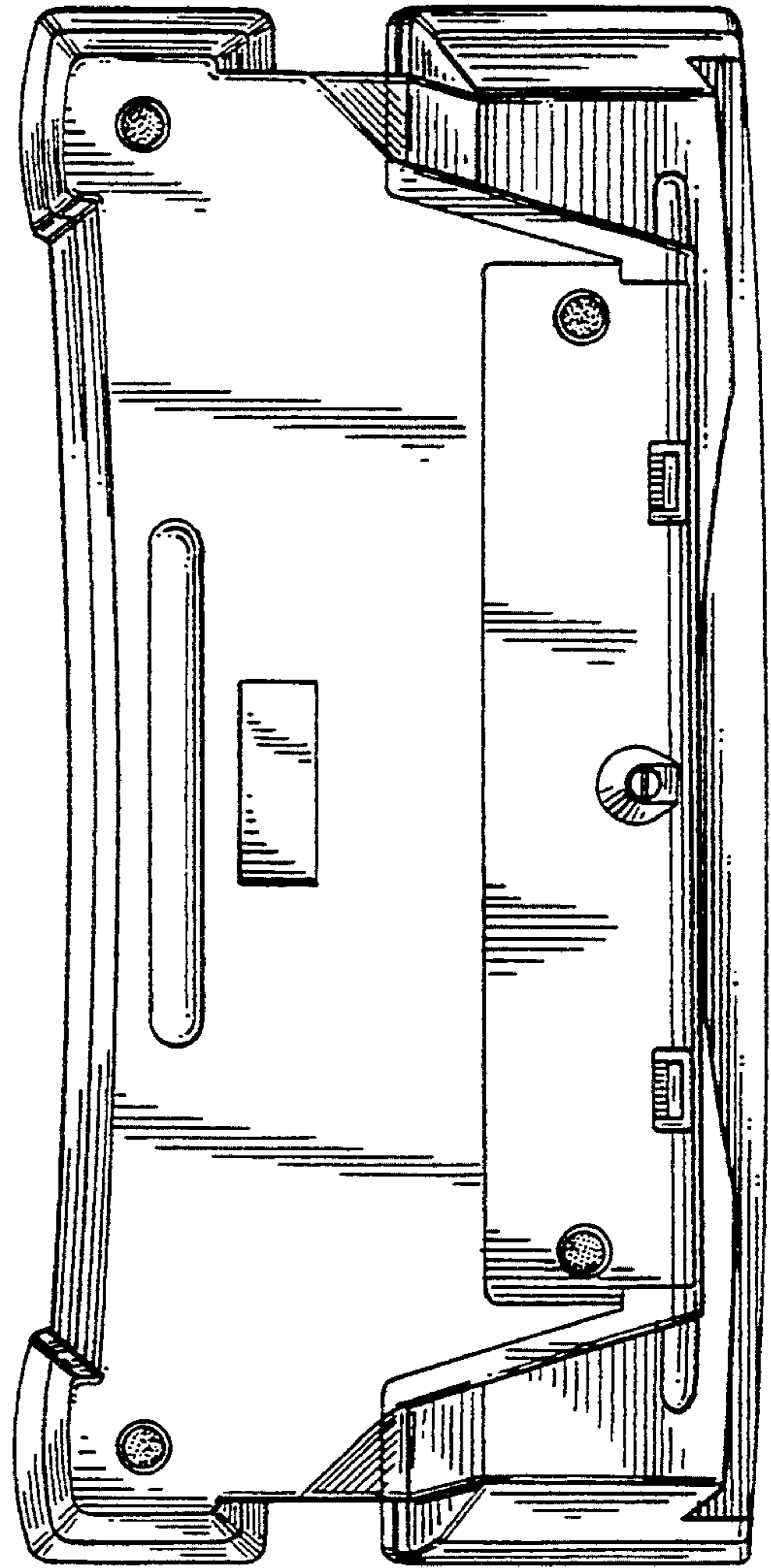

FIG. 6

FIG. 7

