



US00D361683S

United States Patent [19]

[11] Patent Number: **Des. 361,683**

Juhl

[45] Date of Patent: **** Aug. 29, 1995**

[54] **REMOVABLE LAWN CHAIR HEADREST**

[76] Inventor: **Darrol L. Juhl**, 5411 Palm Crest Ct., Pinellas Park, Fla. 34666

[**] Term: **14 Years**

[21] Appl. No.: **19,639**

[22] Filed: **Mar. 8, 1994**

[52] U.S. Cl. **D6/501; D6/601**

[58] Field of Search **D6/500-502, D6/491, 601, 611; 5/653; 29/218, 219.1, 220, 221, 391, 396, 397**

[56] **References Cited**

U.S. PATENT DOCUMENTS

D. 332,371	1/1993	Gurman	D6/601
2,661,050	12/1953	Felter	297/391 X
3,504,941	4/1970	Gerard	297/219.1 X
3,645,556	2/1972	Kobori	297/397 X
4,725,094	2/1988	Greer	297/220 X
4,877,288	10/1989	Lee	D6/611 X

Primary Examiner—Janice E. Seeger
Attorney, Agent, or Firm—James E. Larson; Herbert W. Larson

[57] **CLAIM**

The ornamental design for a removable lawn chair head rest, as shown and described.

DESCRIPTION

FIG. 1 is a front perspective view of a removable lawn chair headrest showing my new design, the broken lines are for environmental purposes only and form no part of the claimed design;

FIG. 2 is a front elevational view thereof;

FIG. 3 is a back elevational view thereof;

FIG. 4 is a left side elevational view thereof;

FIG. 5 is a right side elevational view thereof;

FIG. 6 is a top plan view thereof;

FIG. 7 is bottom plan view thereof;

FIG. 8 is a cross sectional view thereof along lines 8—8 of FIG. 9; and,

FIG. 9 is a rear perspective view thereof.

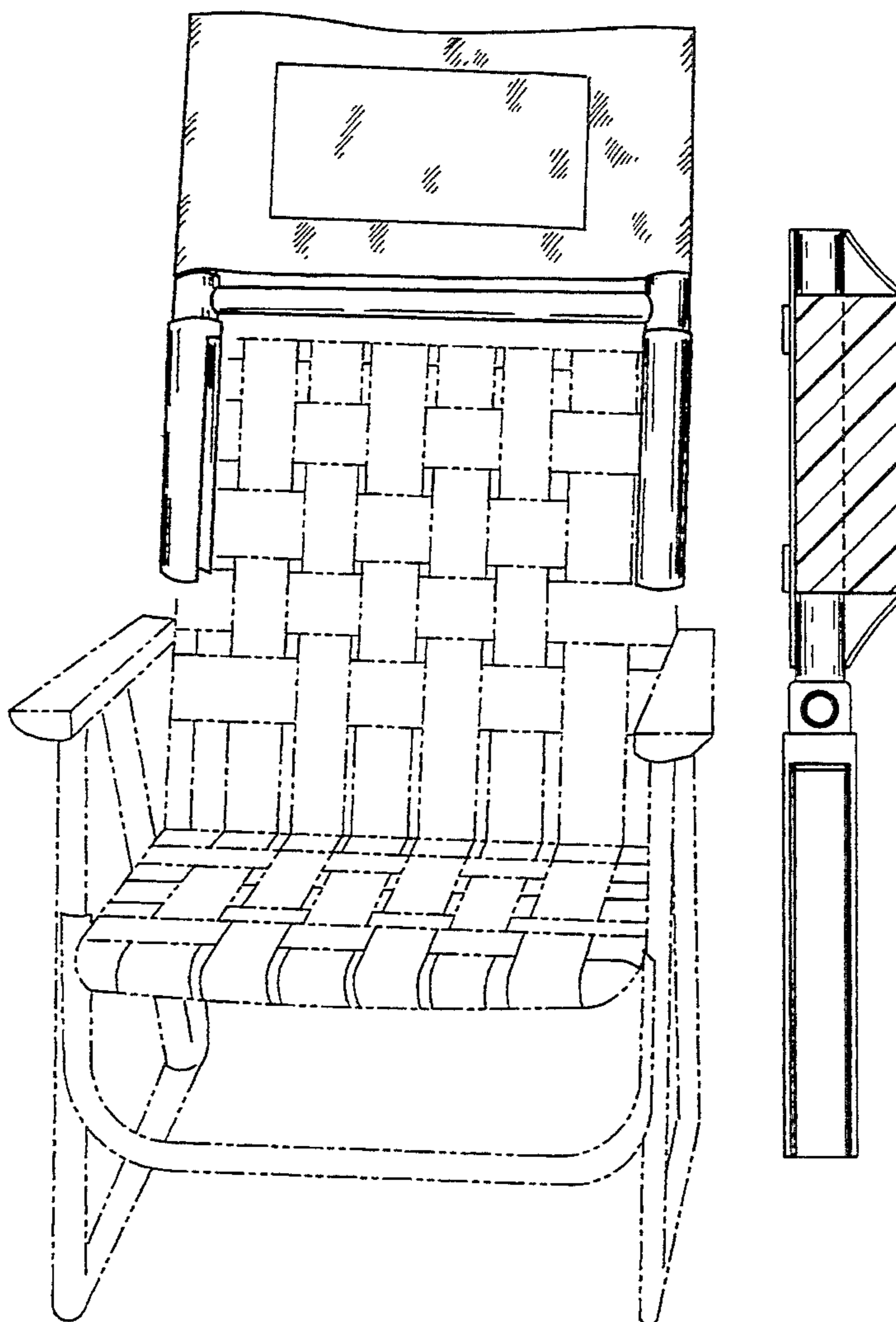

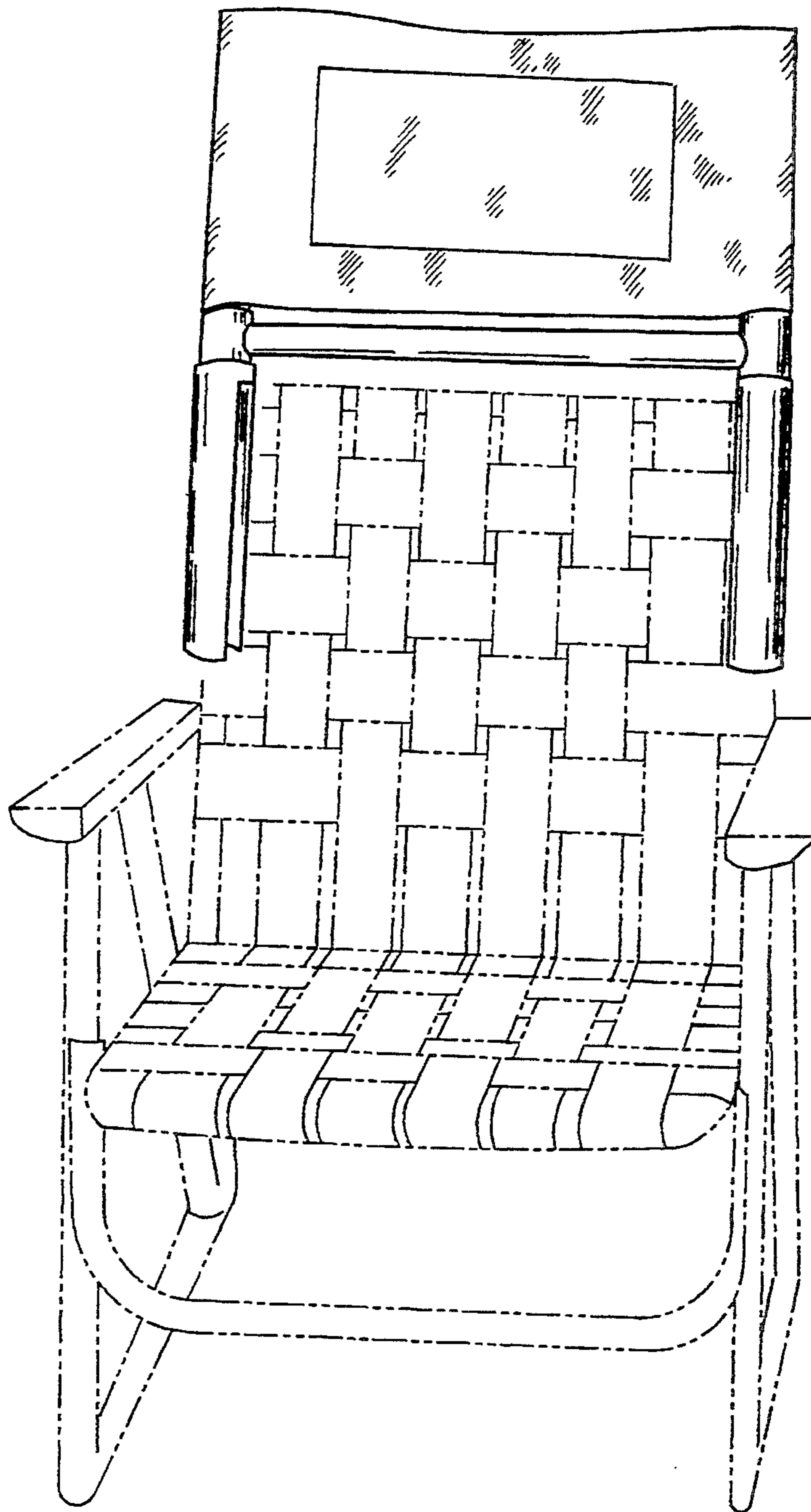
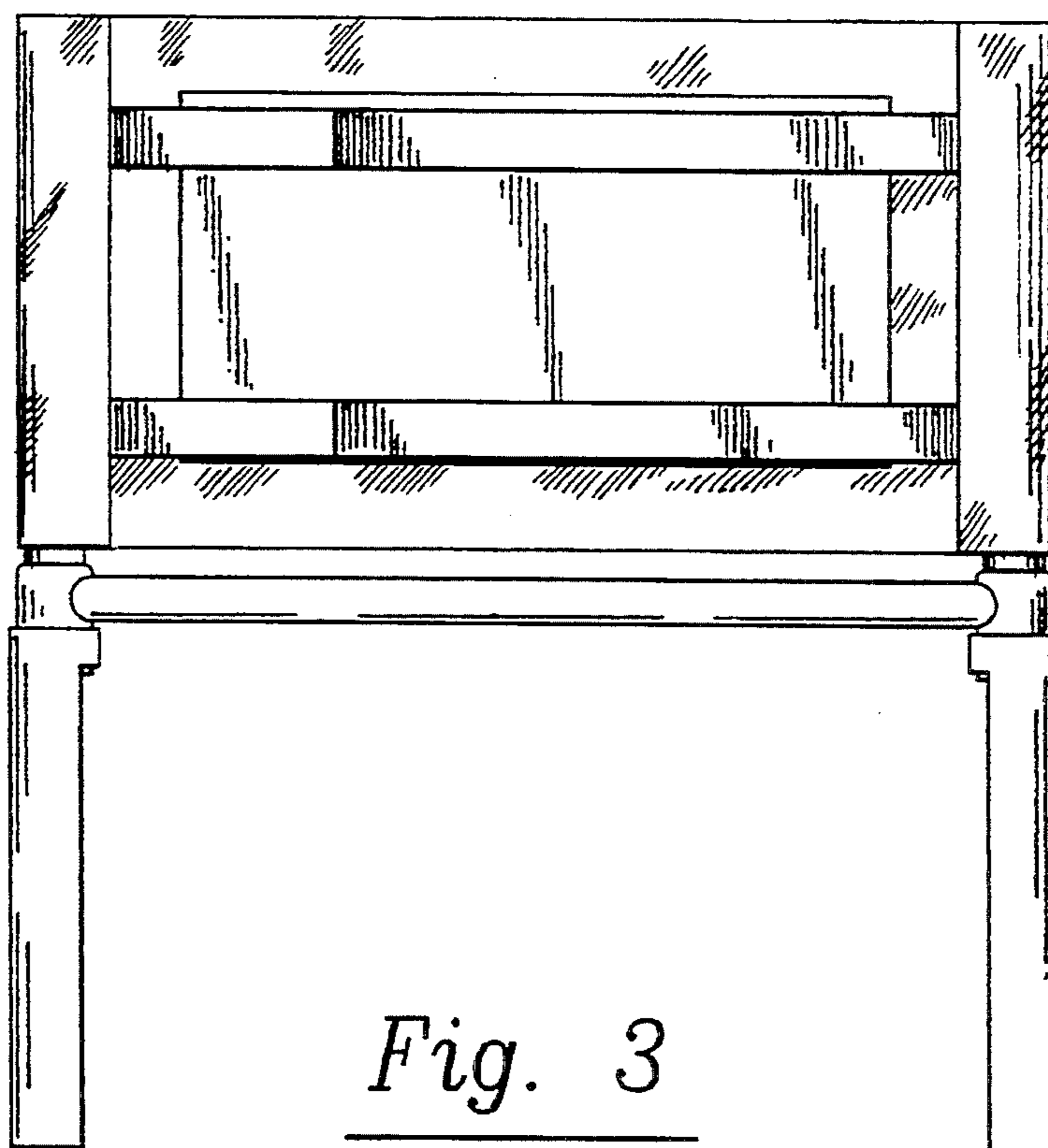
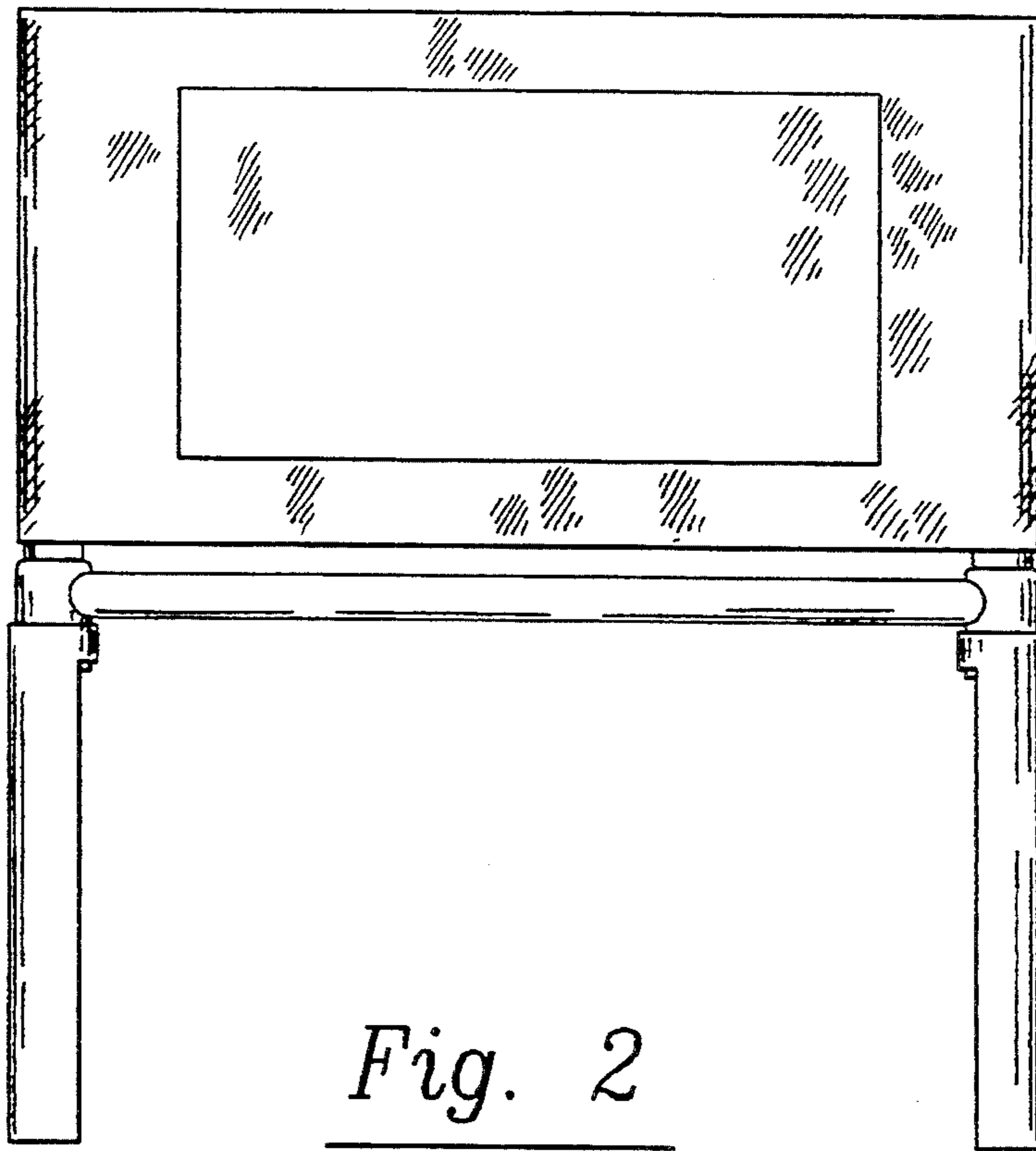

Fig. 1



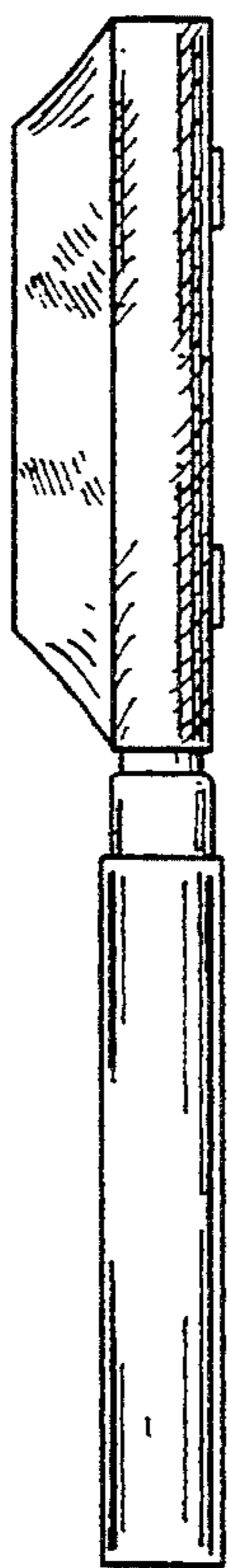

Fig. 4

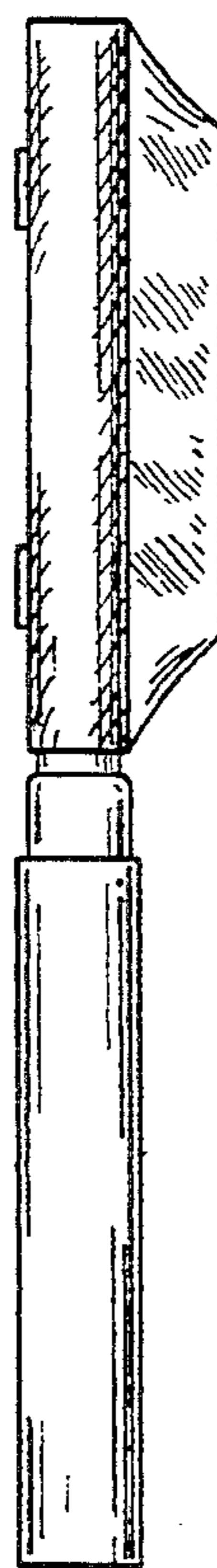

Fig. 5

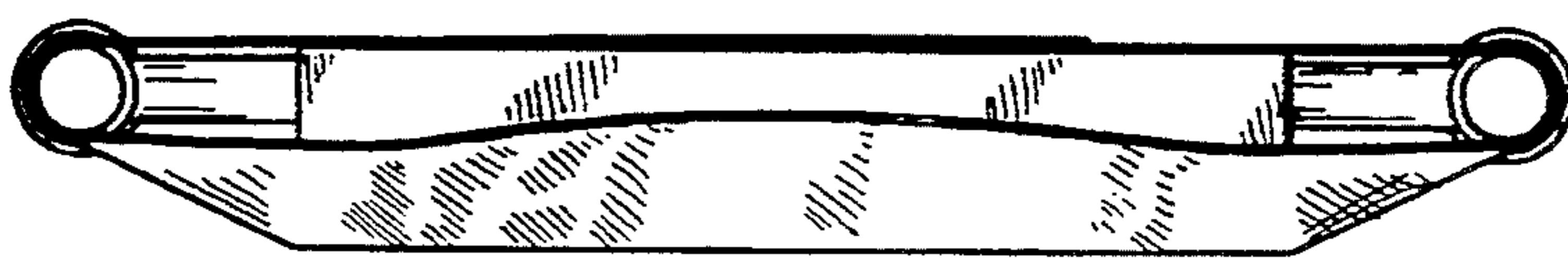

Fig. 6



Fig. 7

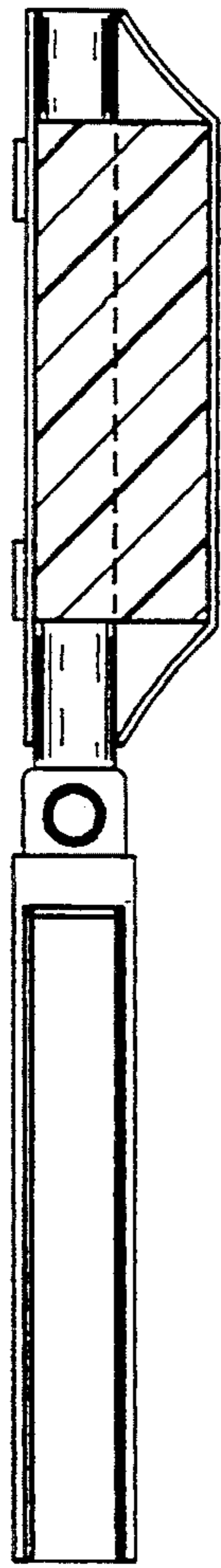

Fig. 8

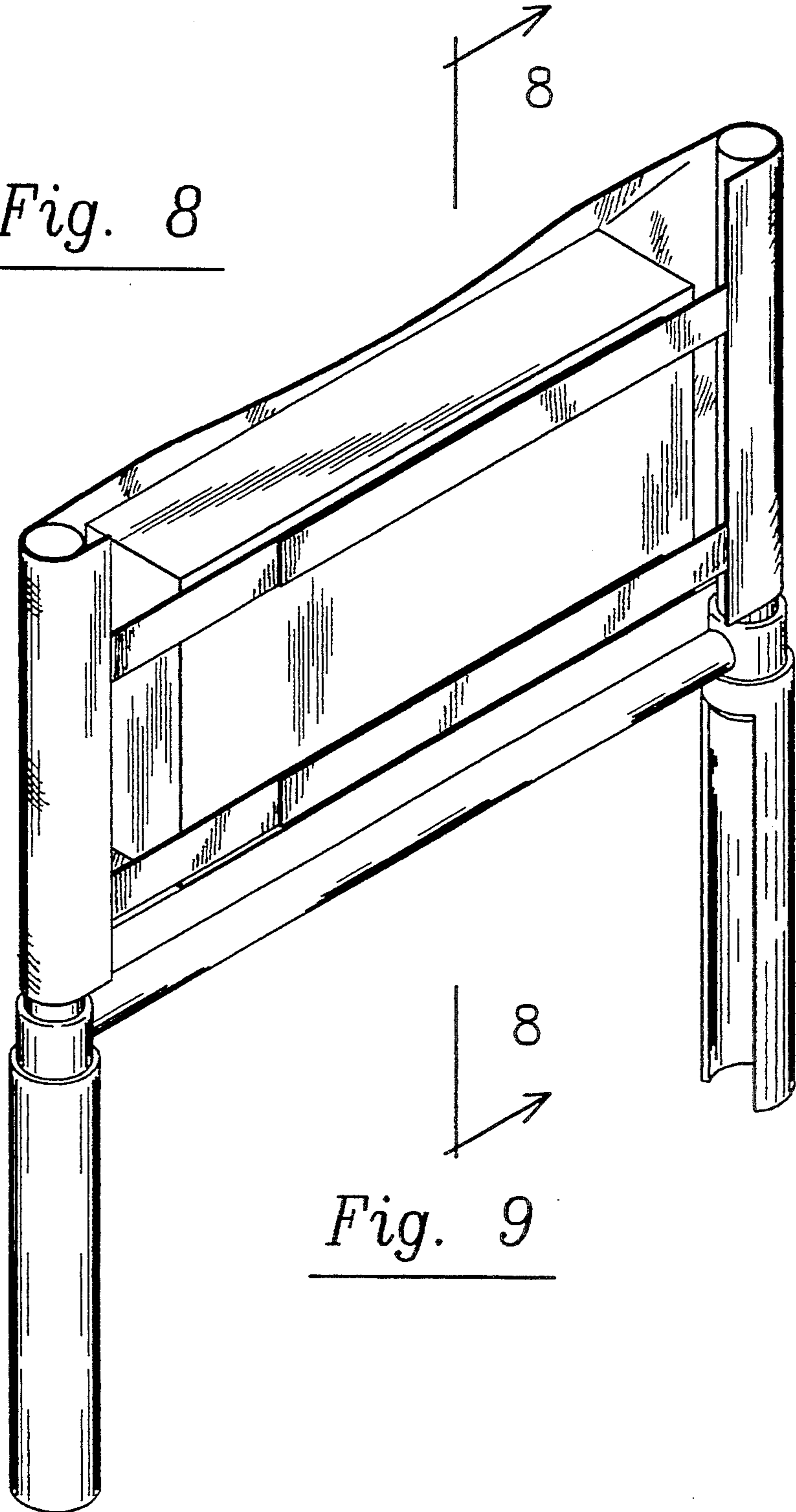

Fig. 9