



US00D361621S

United States Patent [19]

Johnson

[11] Patent Number: **Des. 361,621**

[45] Date of Patent: **** Aug. 22, 1995**

[54] **HAND THERAPY BOARD**

[76] Inventor: **Cloyed R. Johnson**, 2822 Pineswept St., Pasadena, Tex. 77503

[**] Term: **14 Years**

[21] Appl. No.: **26,278**

[22] Filed: **Jul. 25, 1994**

[52] U.S. Cl. **D24/188**

[58] Field of Search D24/188, 189, 200; 601/40; 482/5, 44-49

4,822,027 4/1989 Kascak 482/46
 4,856,772 8/1989 Kaplan 482/44

Primary Examiner—Stella Reid

[57] CLAIM

The ornamental design for a hand therapy board, as shown and described.

DESCRIPTION

FIG. 1 is a front elevational view of the hand therapy board showing my new design;
 FIG. 2 is a rear elevational view thereof;
 FIG. 3 is a left side elevational view thereof;
 FIG. 4 is a right side elevational view thereof;
 FIG. 5 is a top plan view thereof;
 FIG. 6 is a bottom plan view thereof; and,
 FIG. 7 is an isometric view showing a use thereof.

- [56] **References Cited**
- U.S. PATENT DOCUMENTS**
- | | | | | |
|------------|---------|-------------|-------|---------|
| D. 306,646 | 3/1990 | Cotton | | D24/200 |
| D. 312,311 | 11/1990 | Cotton | | D24/189 |
| D. 327,328 | 6/1992 | Luce et al. | | D24/188 |

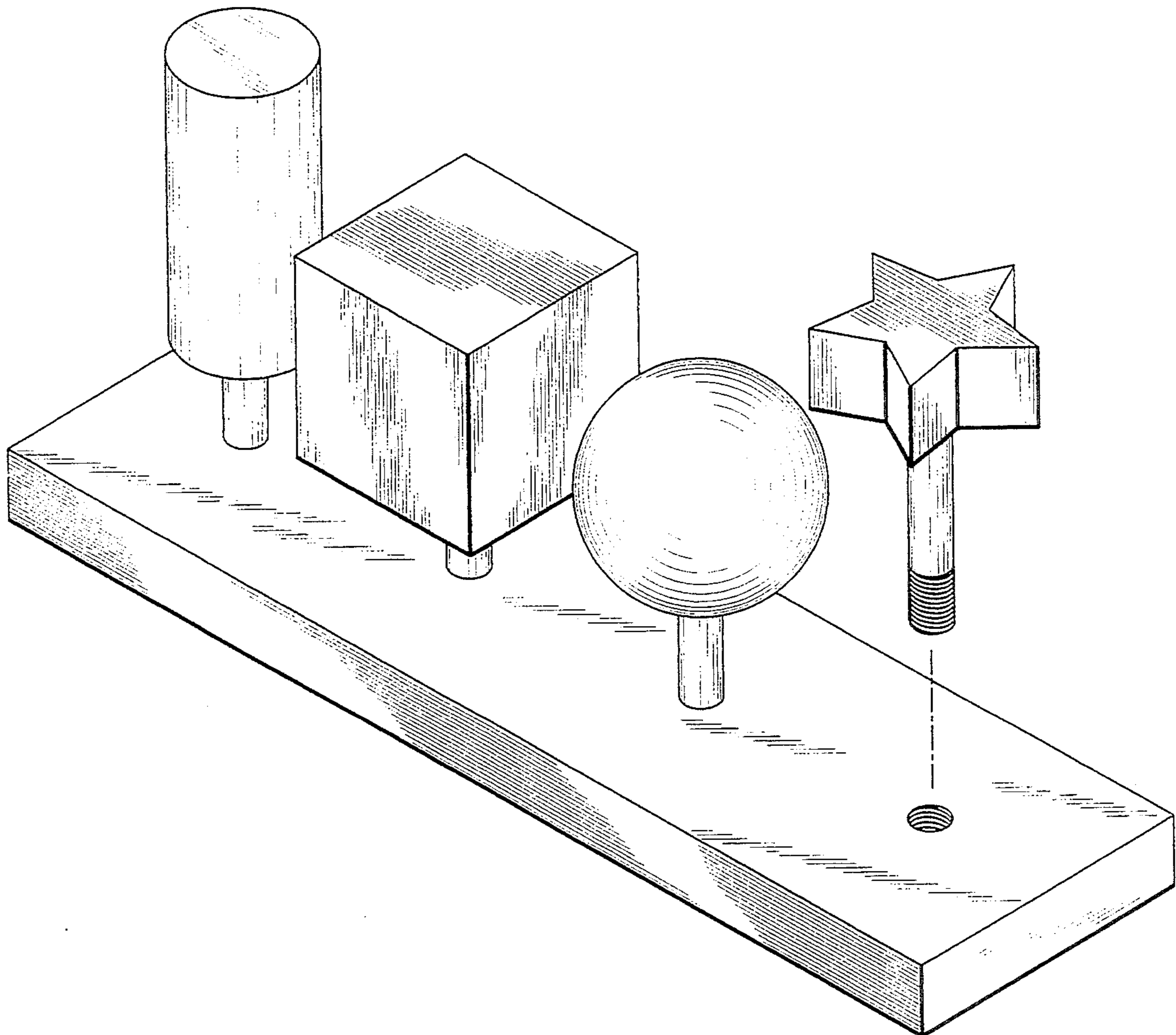

FIG. 1

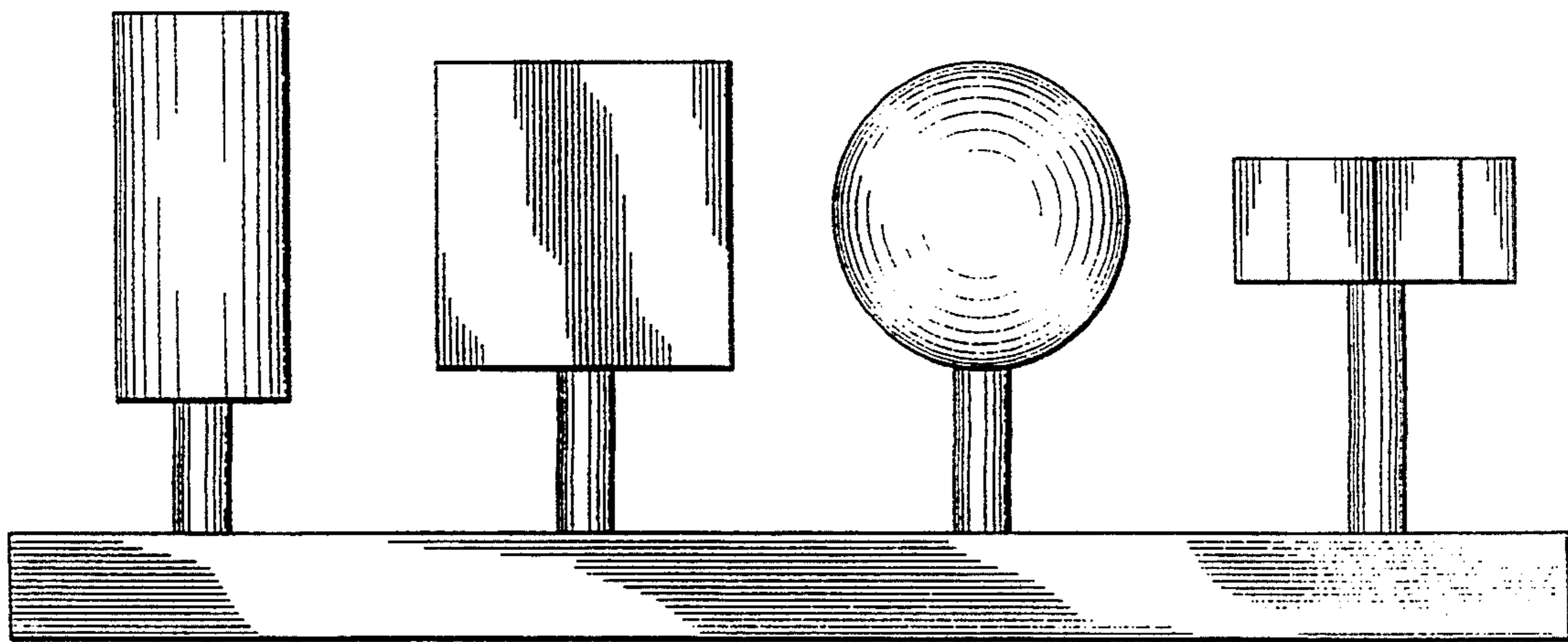

FIG. 2

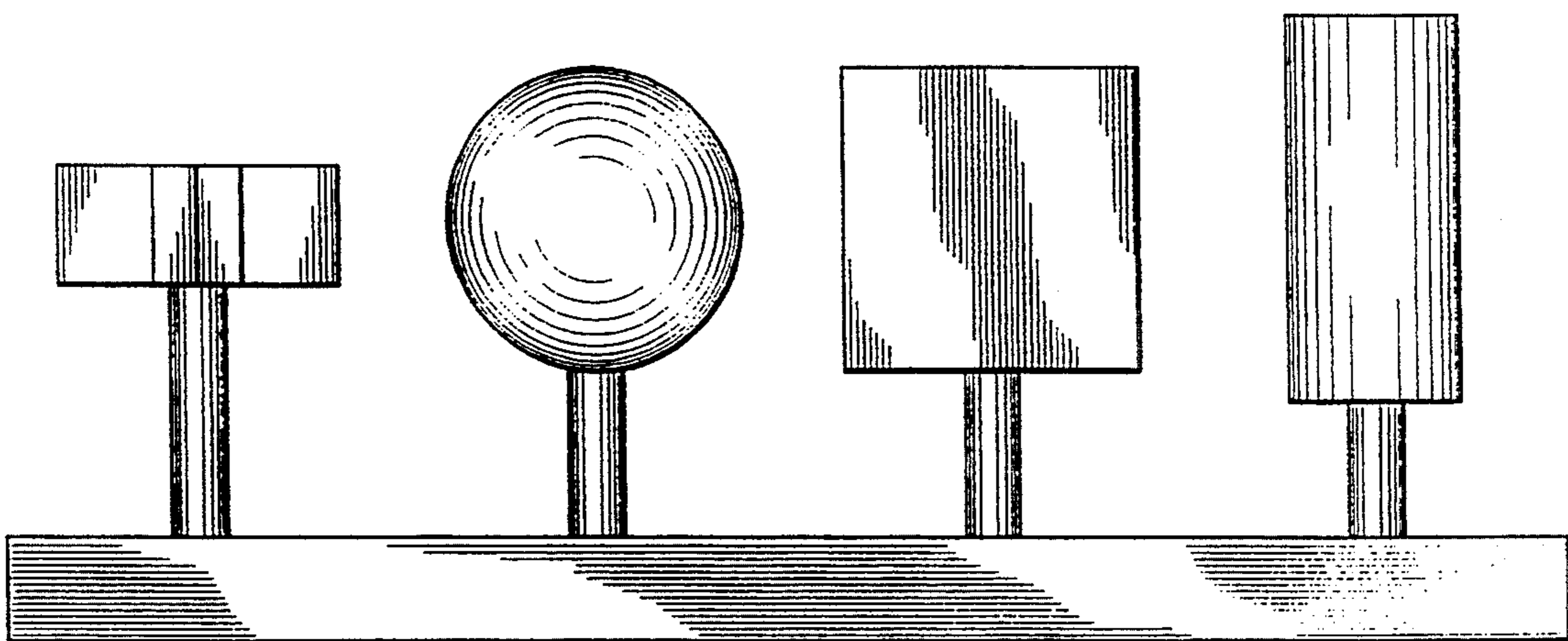

FIG. 3

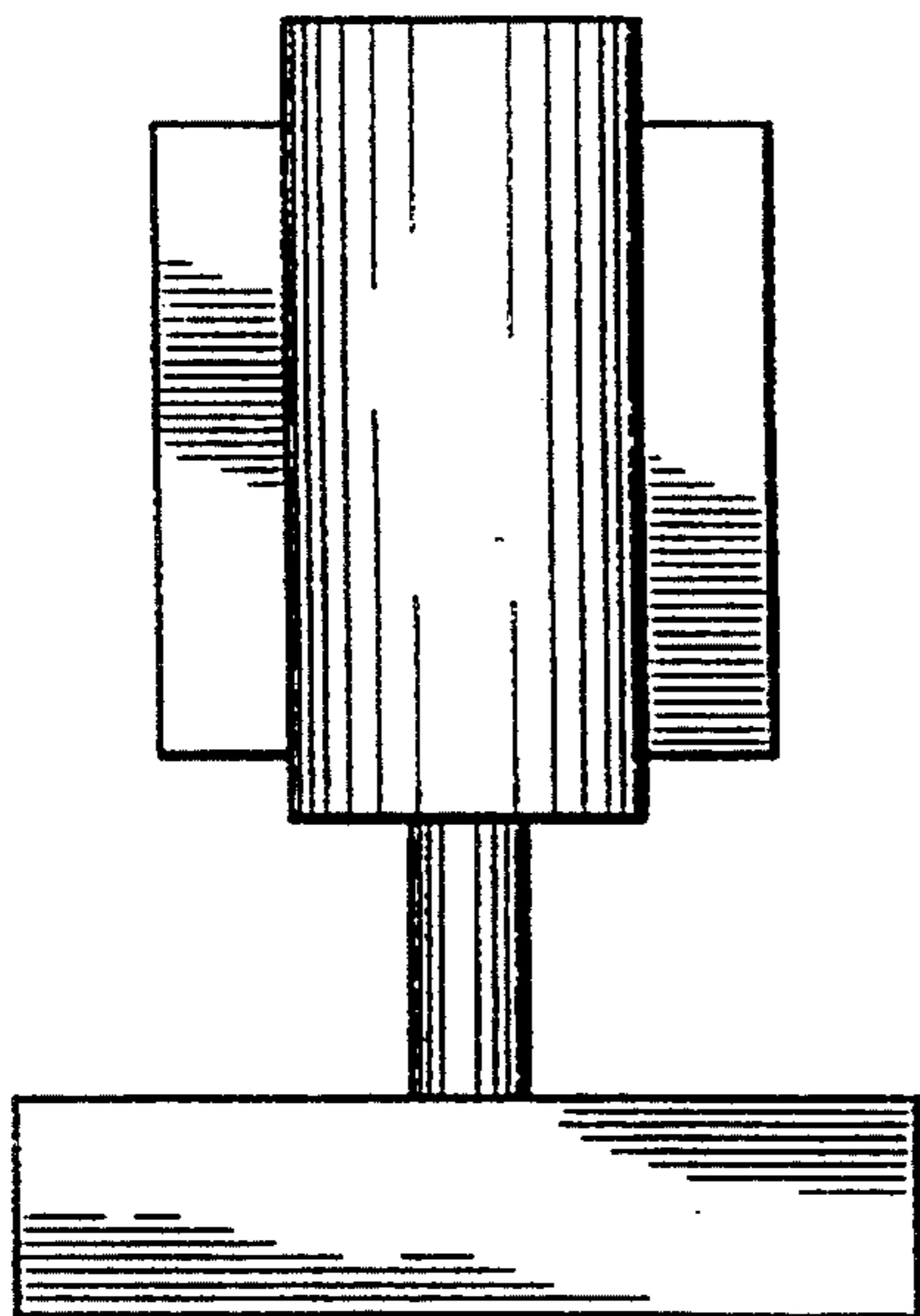

FIG. 4

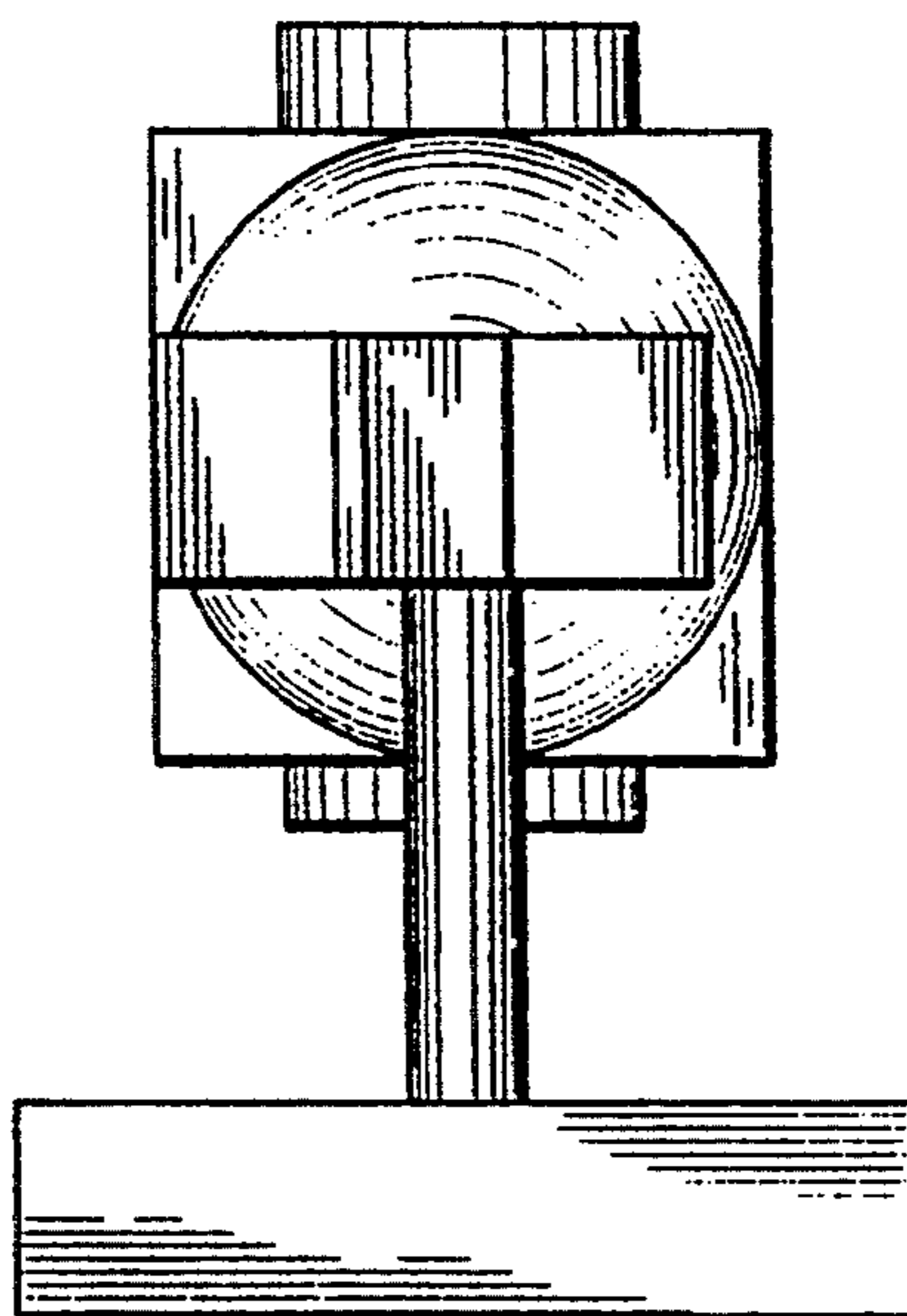

FIG. 5

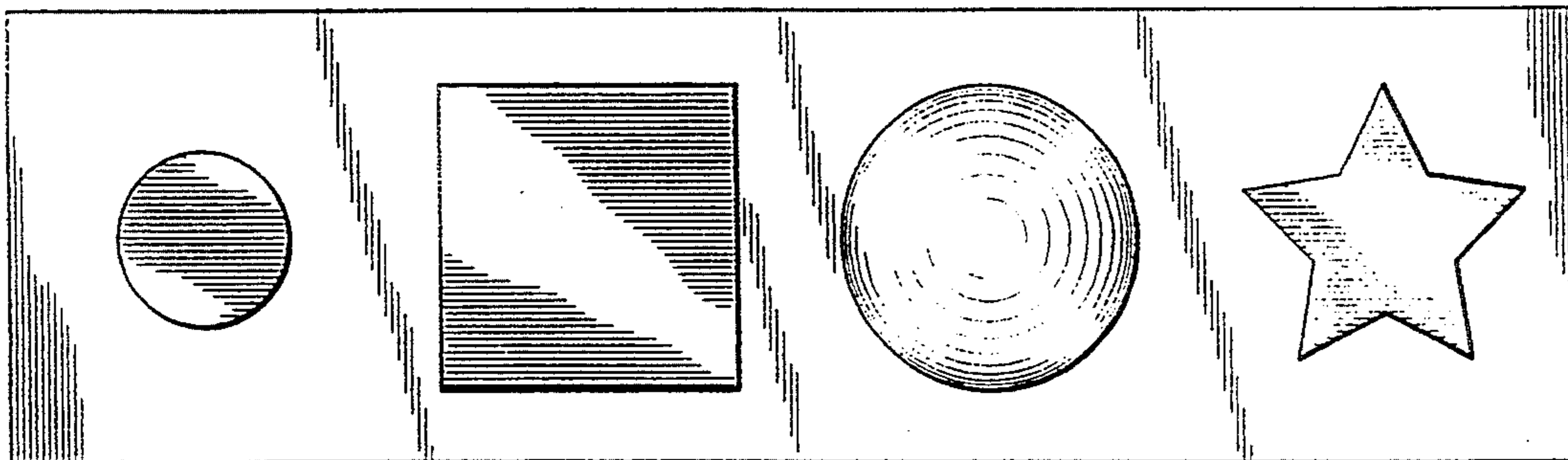

FIG. 6

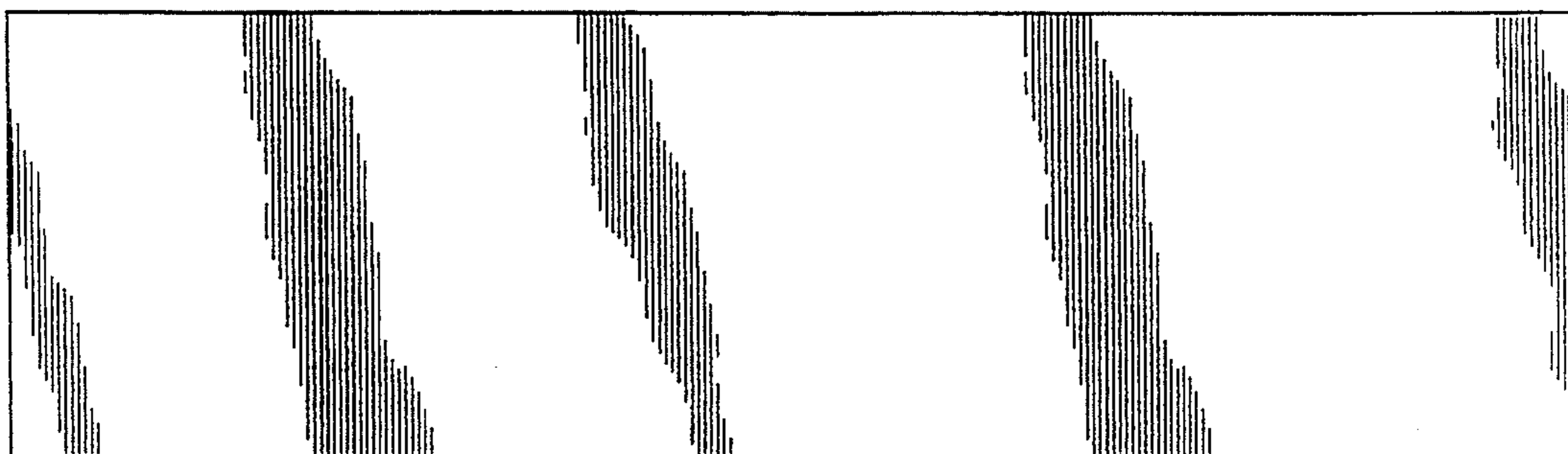

FIG. 7

