



US00D361438S

# United States Patent [19]

[11] Patent Number: Des. 361,438

Spencer et al.

[45] Date of Patent: \*\* Aug. 22, 1995

[54] DENTAL PATIENT CHAIR

[75] Inventors: John W. Spencer, Dundee; Barry S. Young, Tualatin; Richard W. Hanson, Sherwood; John W. Lewis, Newberg, all of Oreg.

[73] Assignee: MDT Corporation, Torrance, Calif.

[\*\*] Term: 14 Years

[21] Appl. No.: 14,421

[22] Filed: Oct. 21, 1993

[52] U.S. Cl. .... D6/367

[58] Field of Search ..... D6/334, 360, 361, 364, D6/365, 367, 379, 500, 501, 502; D24/183; 297/344.15, 344.17

[56] References Cited

U.S. PATENT DOCUMENTS

- D. 238,019 12/1985 Leffler et al. .... D6/360
- D. 347,946 6/1994 Nordstrom et al. .... D6/367

Primary Examiner—Alan P. Douglas  
Assistant Examiner—Gary D. Watson

[57] CLAIM

The ornamental design for a dental patient chair, as shown and described.

DESCRIPTION

FIG. 1 is a perspective view of a dental patient chair showing our design;  
 FIG. 2 is a front perspective view of the dental patient chair of FIG. 1;  
 FIG. 3 is a side perspective view of the dental patient chair of FIG. 1;  
 FIG. 4 is the opposite side perspective view of the dental patient chair of FIG. 1;  
 FIG. 5 is a rear perspective view of the dental patient chair of FIG. 1;  
 FIG. 6 is a top plan view of the dental patient chair of FIG. 1; and,  
 FIG. 7 is a bottom plan view of the dental patient chair of FIG. 1.

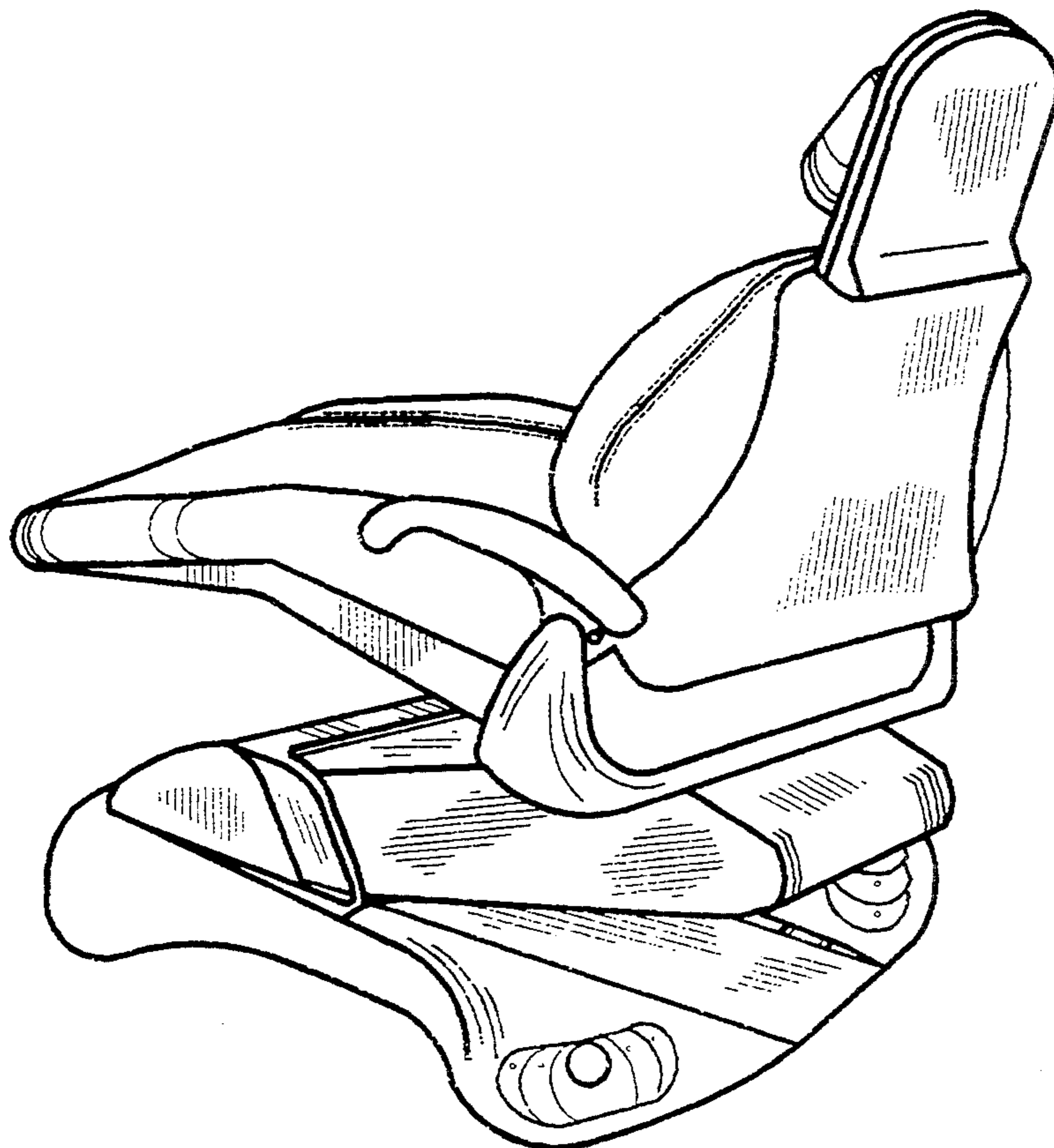

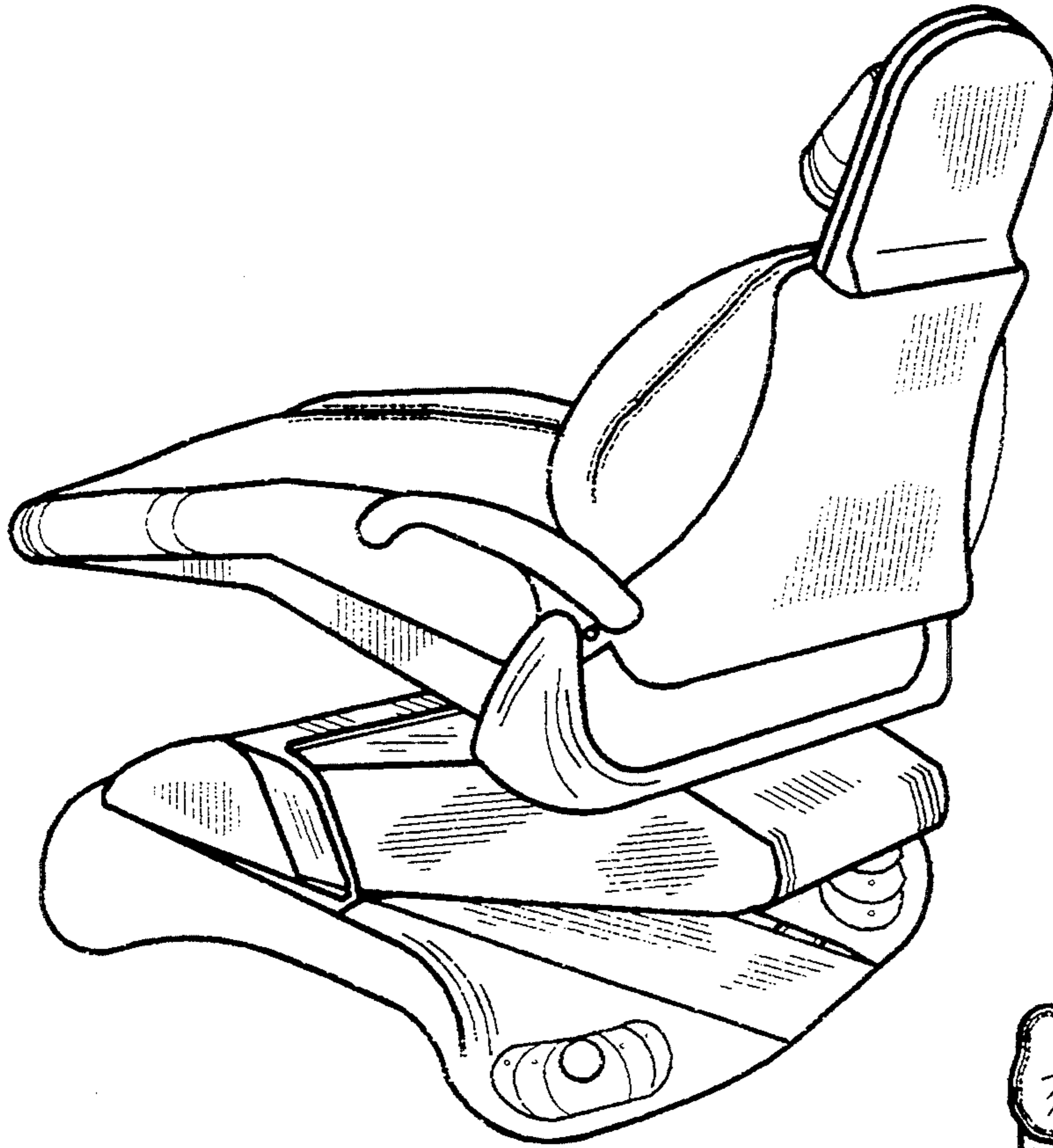

Fig. 1

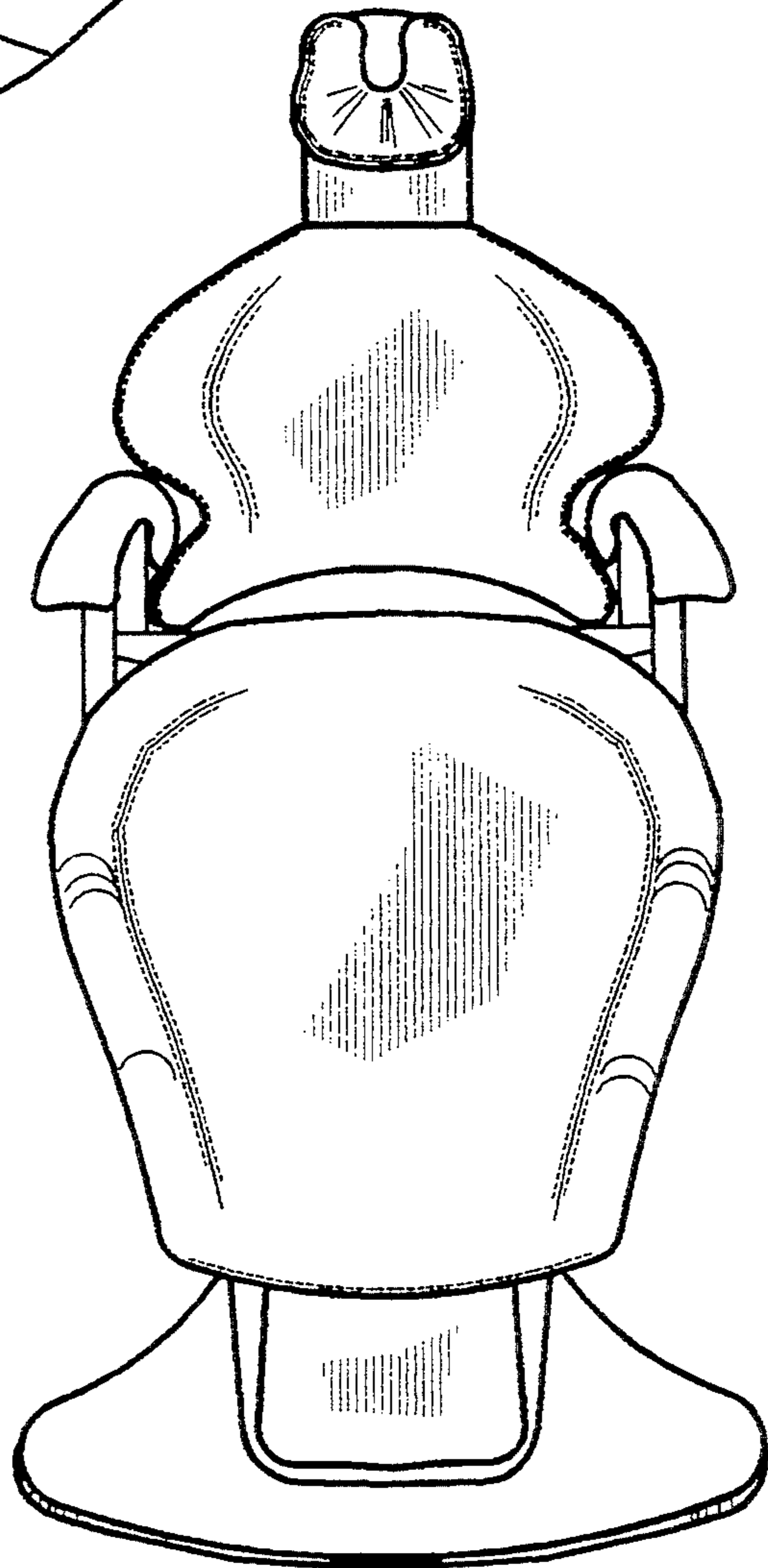

Fig. 2

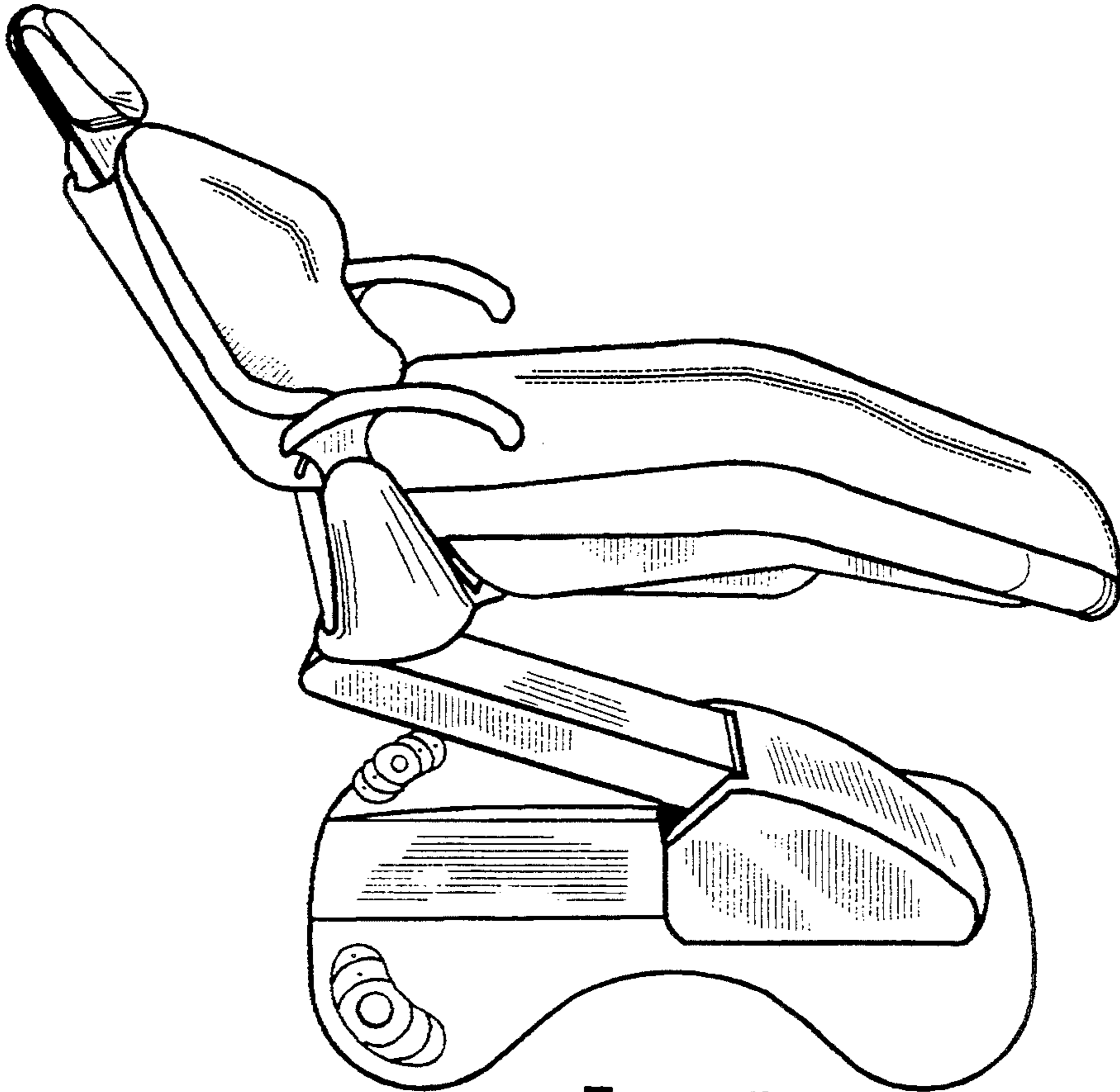

Fig. 3

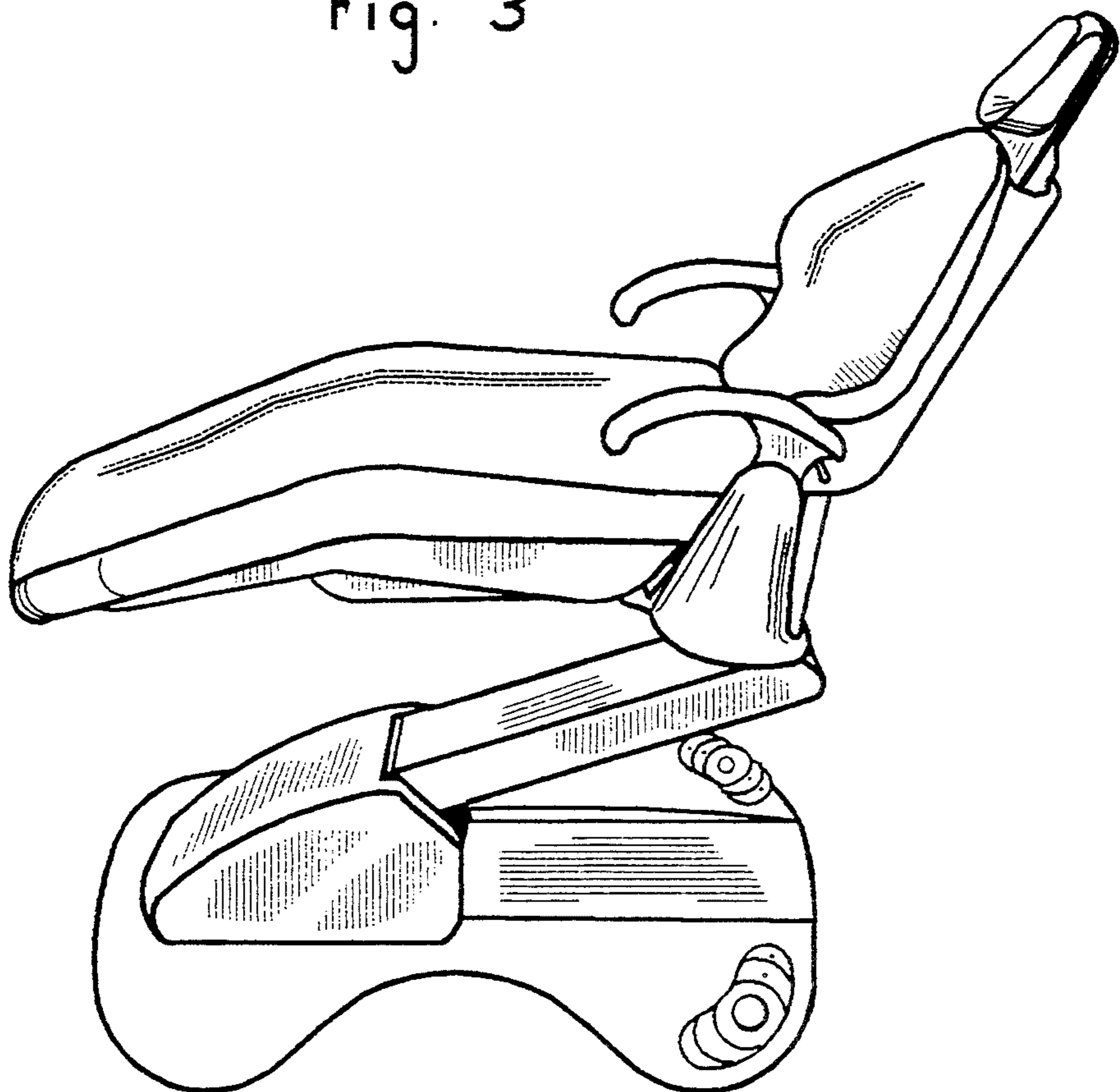

Fig. 4

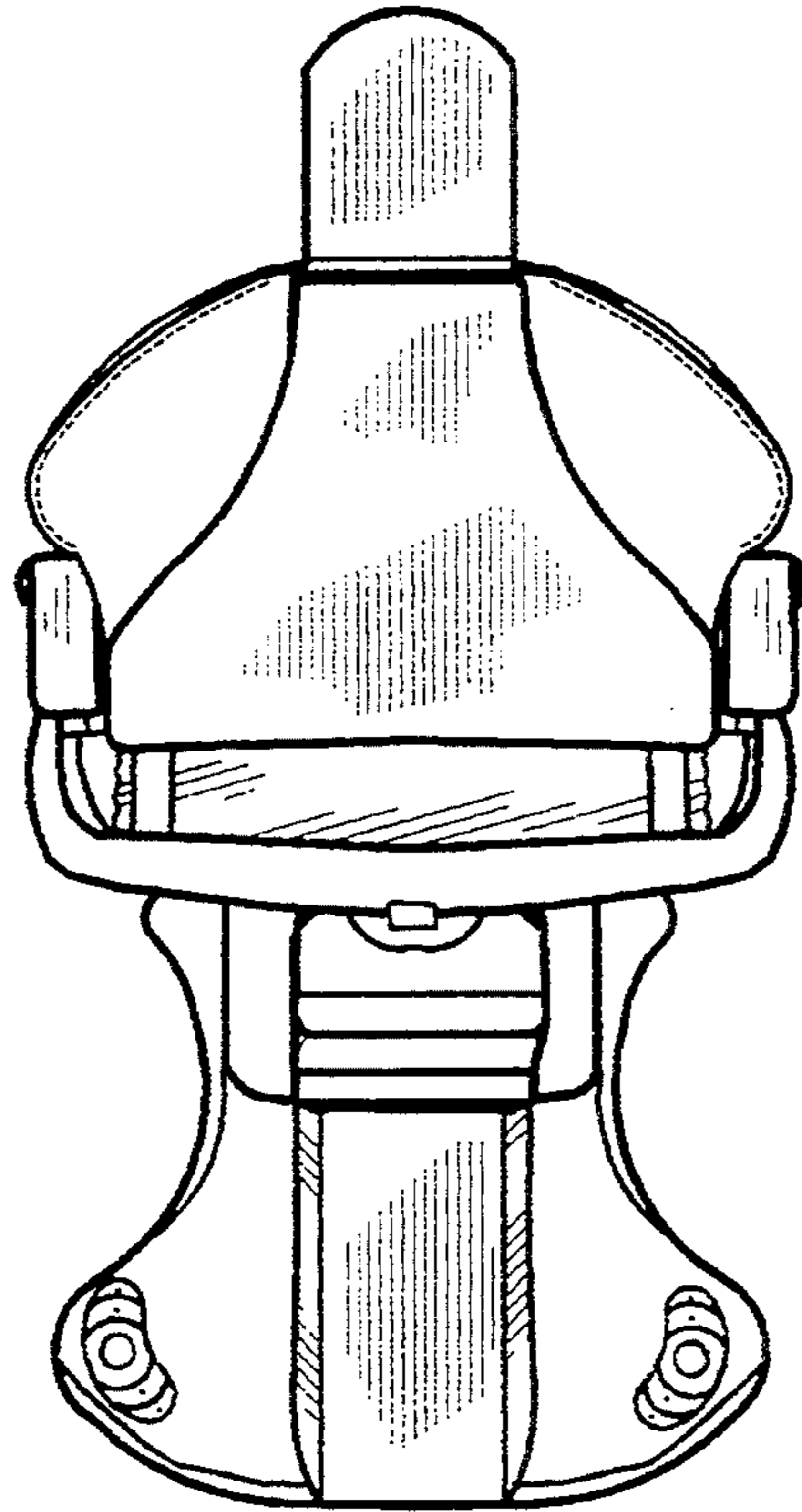

Fig. 5

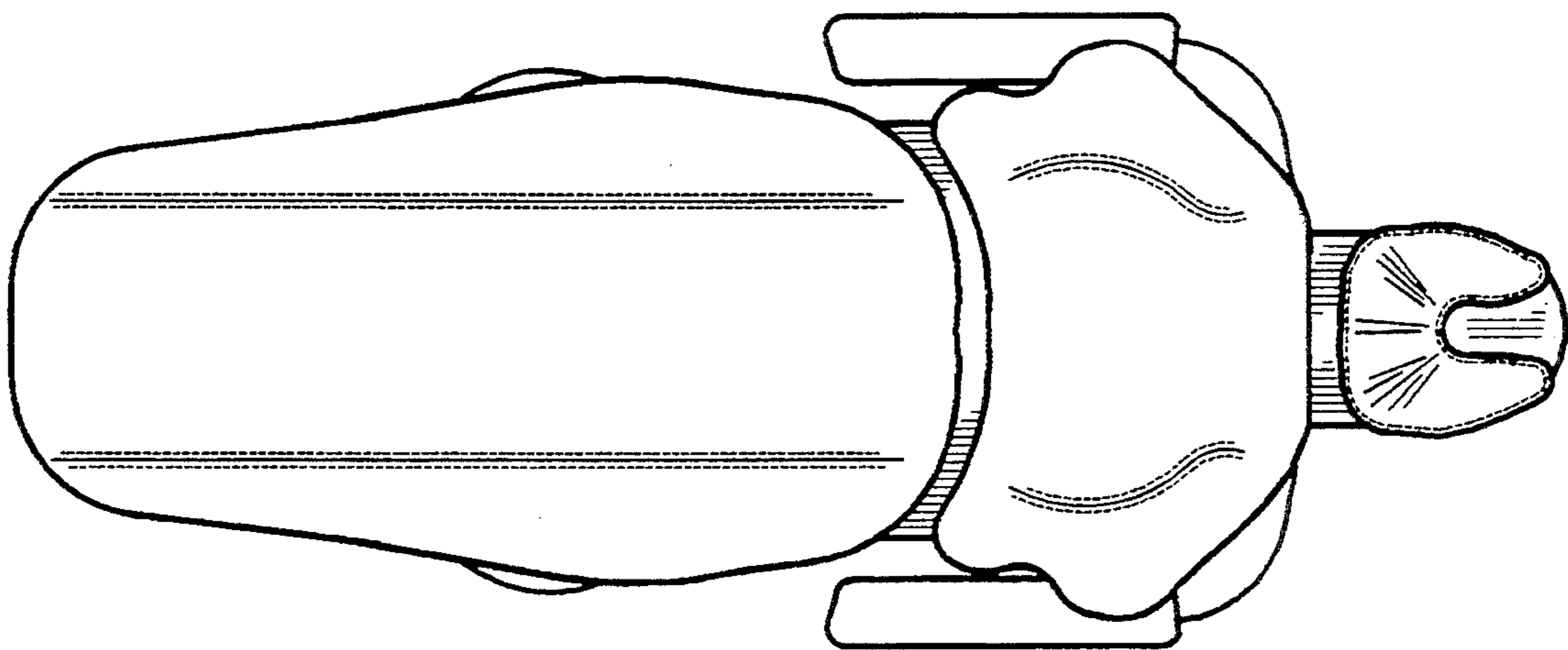

Fig. 6

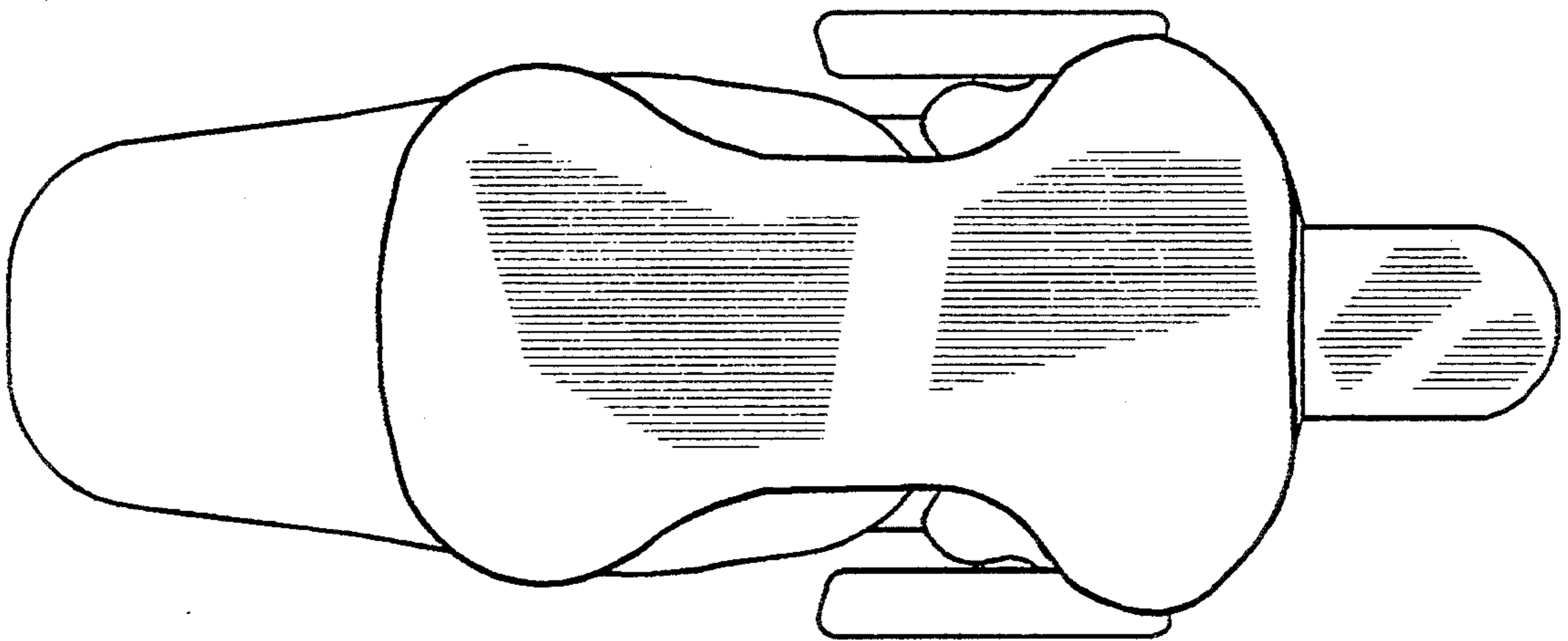

Fig. 7