



US00D361436S

United States Patent [19]
Warshawsky

[11] **Patent Number: Des. 361,436**
[45] **Date of Patent: ** Aug. 22, 1995**

[54] **GRAB BAR HANDLE**

[75] Inventor: **Jerome Warshawsky, Hewlett Harbor, N.Y.**
[73] Assignee: **I.W. Industries, Inc., Melville, N.Y.**
[**] Term: **14 Years**
[21] Appl. No.: **27,869**
[22] Filed: **Aug. 31, 1994**
[52] U.S. Cl. **D8/316**
[58] Field of Search **D8/300, 315-320; D6/546, 549; 211/16; 16/110 R, 111 R**

[57] **CLAIM**

The ornamental design for a grab bar handle, as shown and described.

DESCRIPTION

FIG. 1 is a front and right side perspective view of a grab bar handle showing a first embodiment of my claimed design;
FIG. 2 is a right side elevational view thereof, the left side being a mirror image of that shown;
FIG. 3 is a rear elevational view thereof;
FIG. 4 is a top plan view thereof, the bottom being a mirror image of that shown;
FIG. 5 is a right side elevational view of a grab bar handle showing a second embodiment of my new design, the left side being a mirror image of that shown;
FIG. 6 is a rear elevational view thereof;
FIG. 7 is a front and right side perspective view thereof, the top being identical in appearance to that shown in FIG. 4;
FIG. 8 is a right side elevational view of a grab bar handle showing a third embodiment of my new design, the left side being a mirror image of that shown;
FIG. 9 is a rear elevational view thereof; and,
FIG. 10 is a front and right side perspective view thereof, the top being identical in appearance to that shown in FIG. 4.

[56] **References Cited**

U.S. PATENT DOCUMENTS

D. 222,778	12/1971	Clayton	D6/549
D. 246,950	1/1978	Palm, Jr.	D8/316
D. 274,035	5/1984	Pawlow	D8/316
D. 299,111	12/1988	Jans	D8/316
D. 301,200	5/1989	Jans	D8/316 X
D. 312,763	12/1990	Tremonti	D8/316

Primary Examiner—Brian N. Vinson
Attorney, Agent, or Firm—Alfred M. Walker

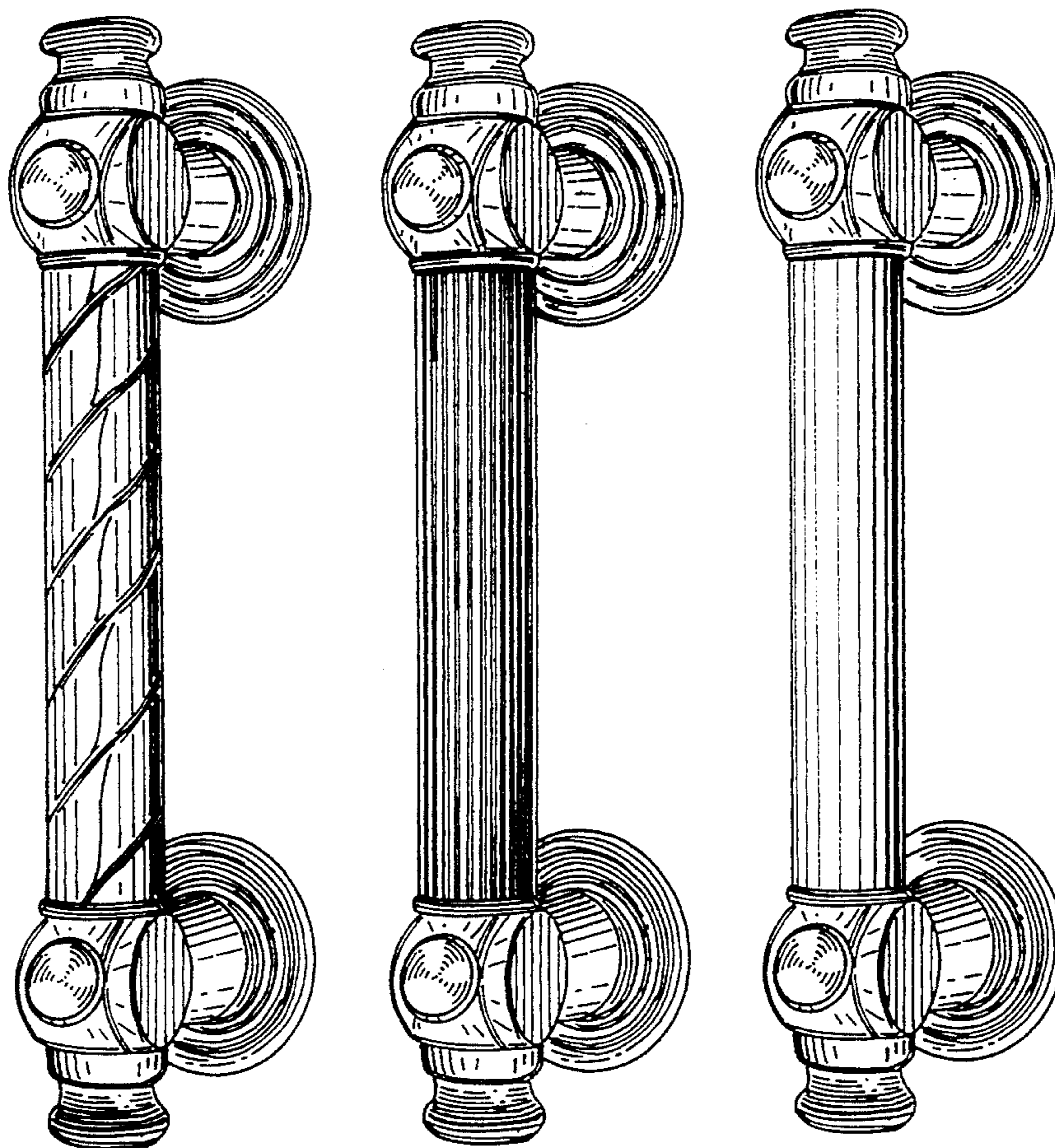

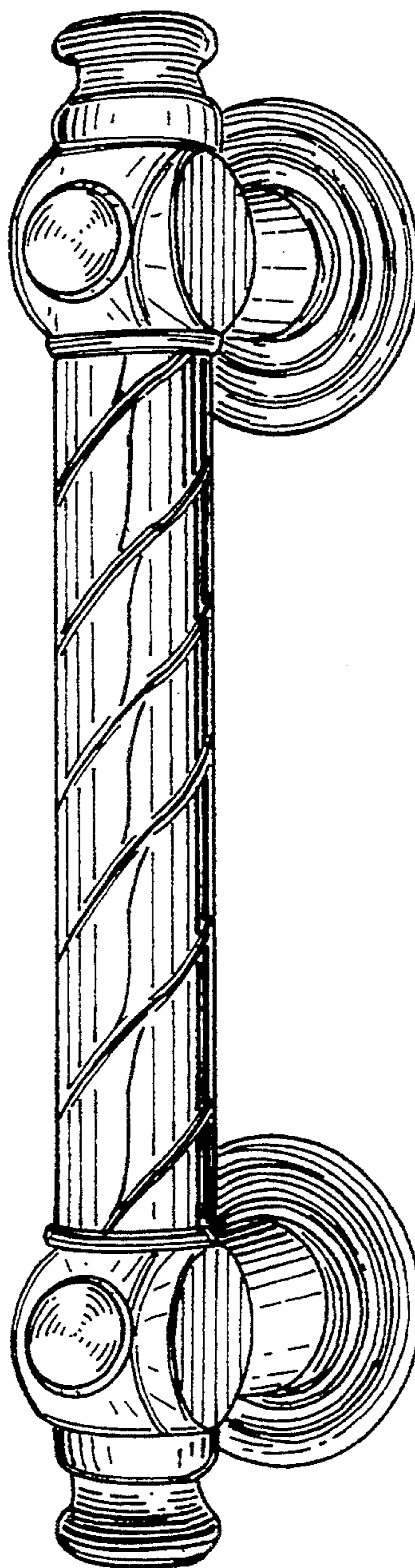

Fig. 1

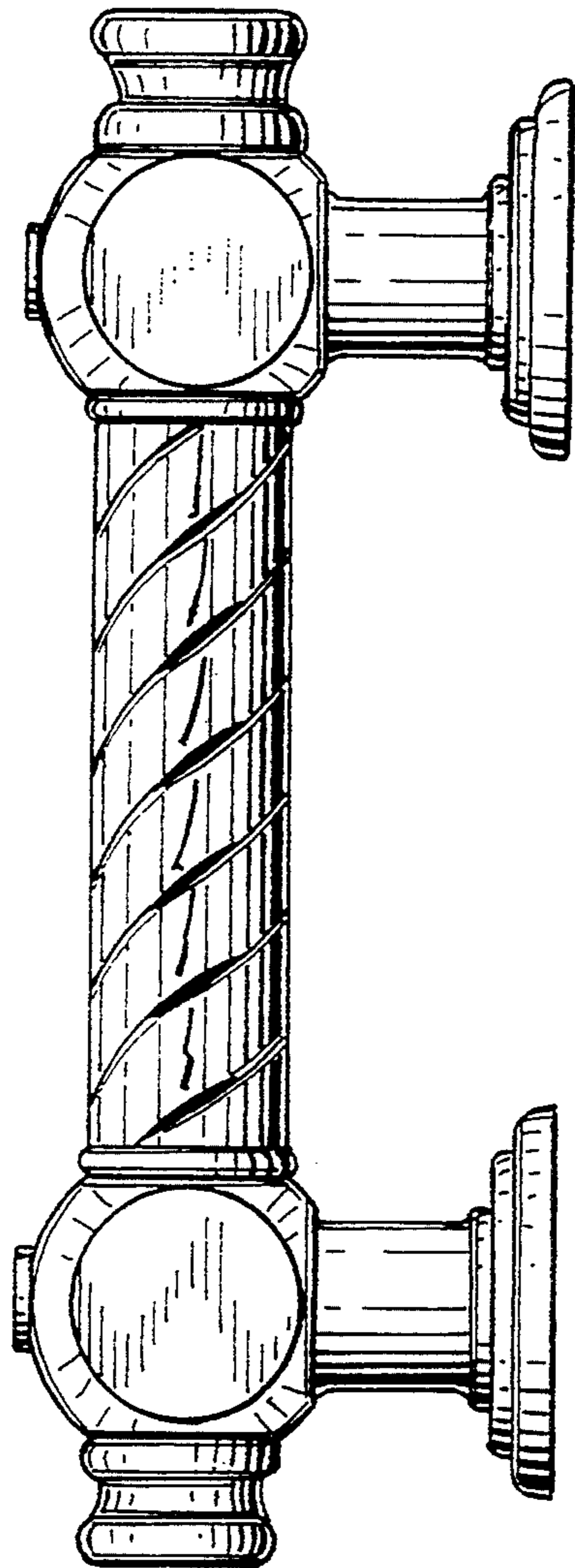

Fig. 2

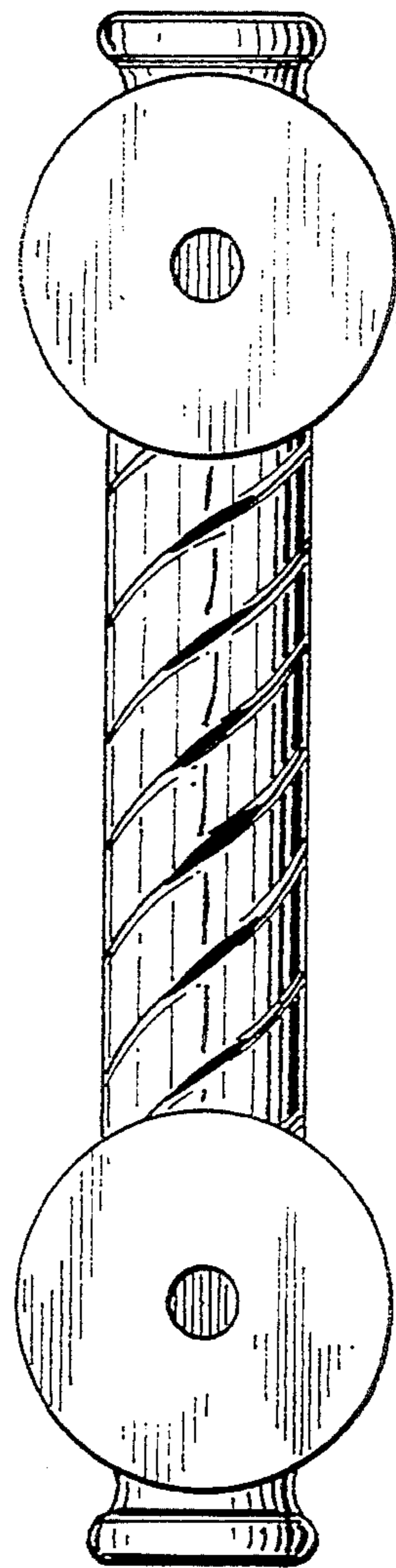

Fig. 3

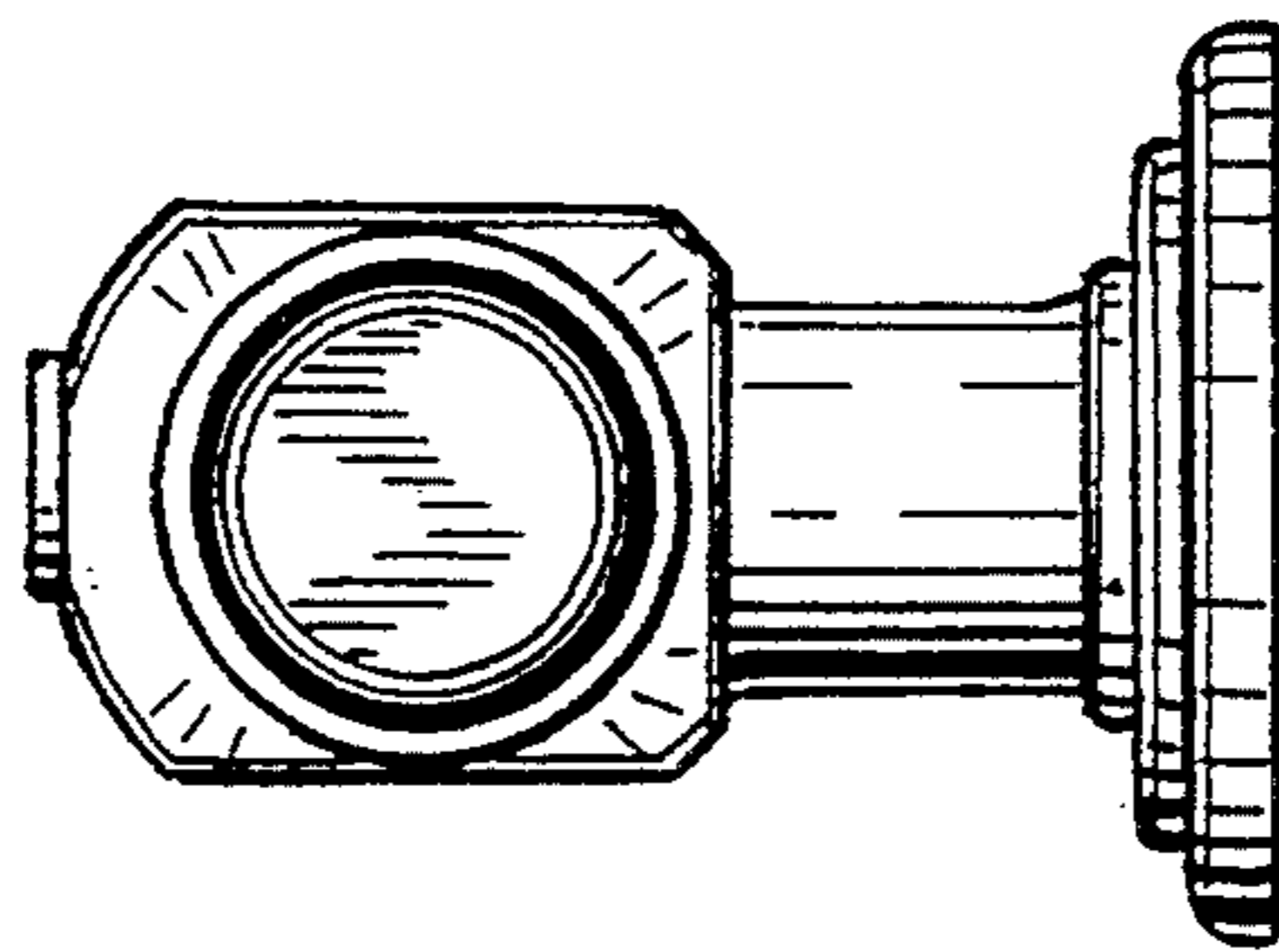

Fig. 4

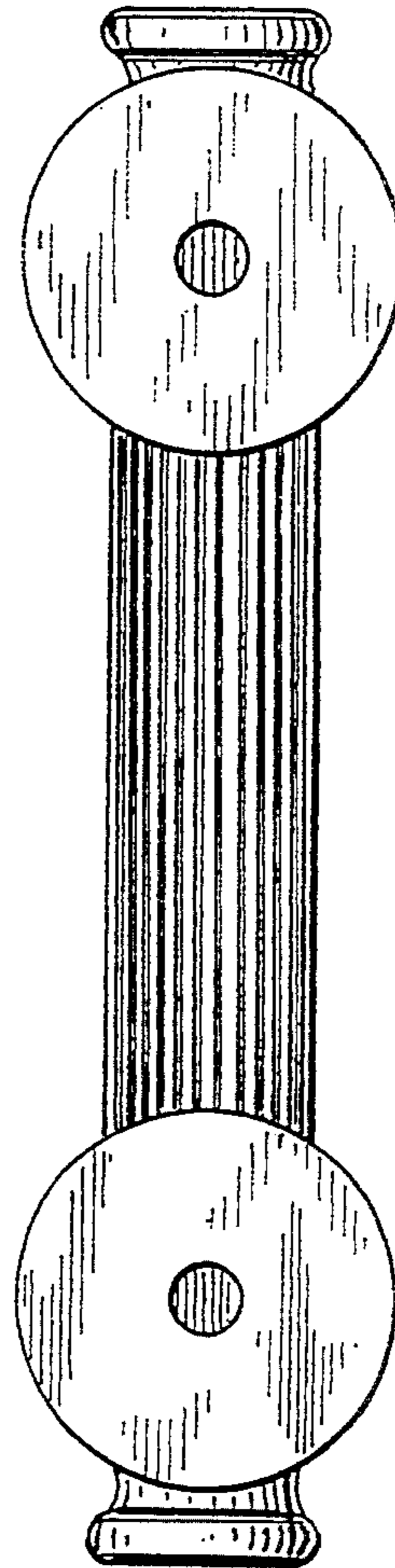
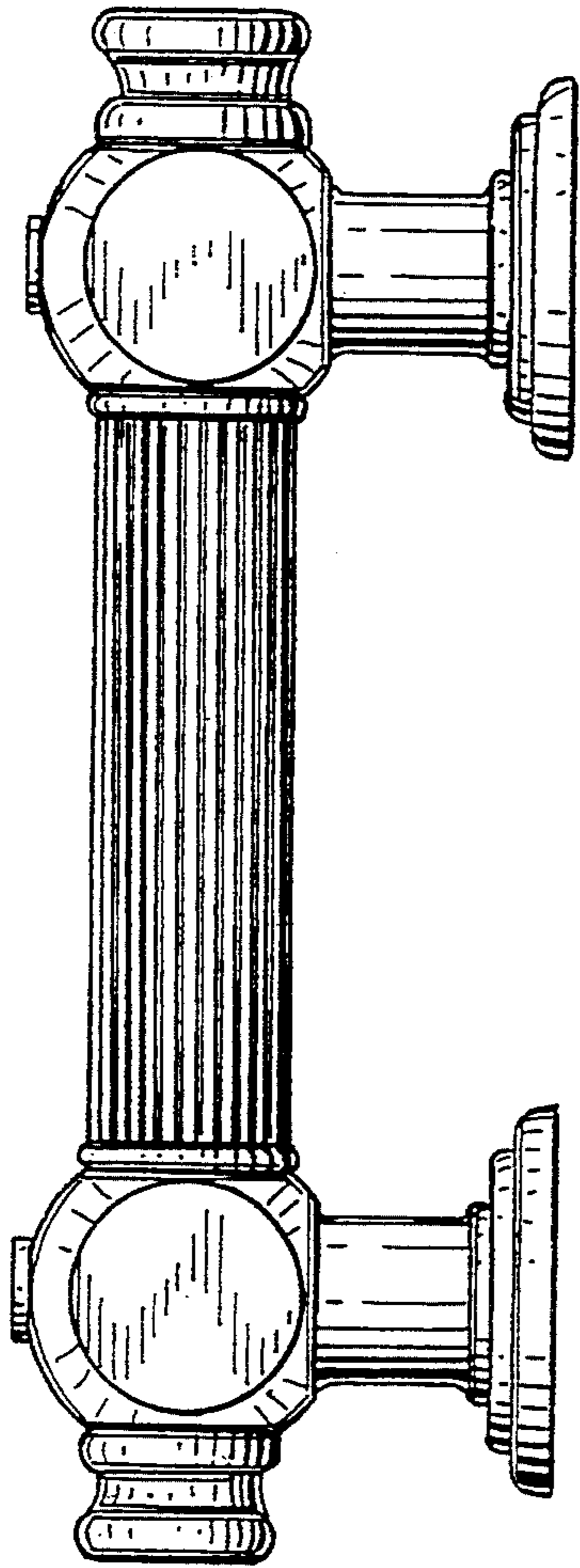

Fig. 5

Fig. 6

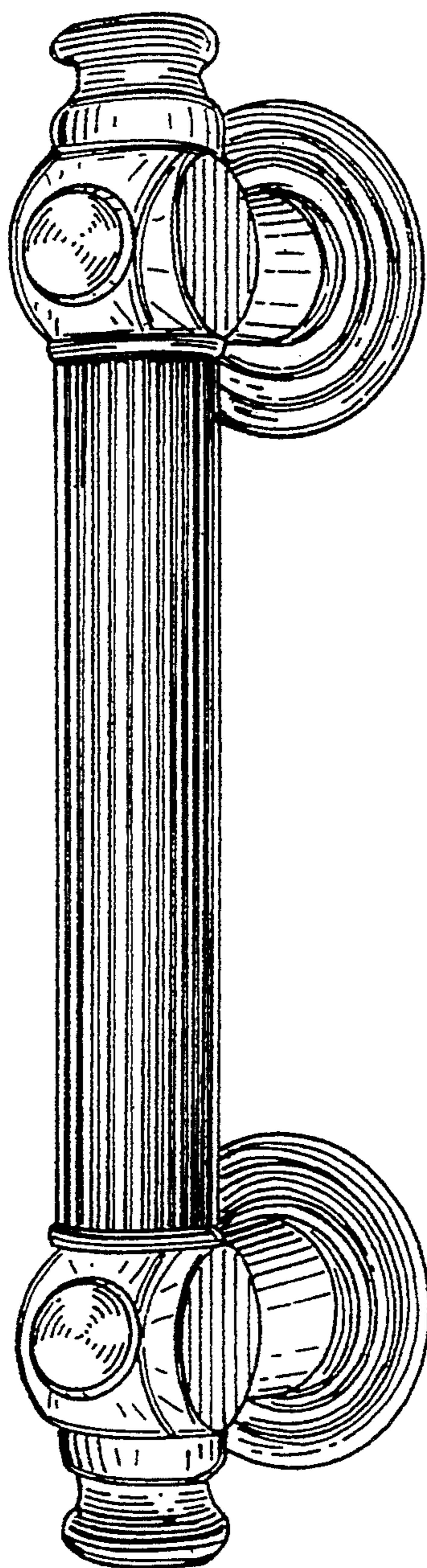

Fig. 7

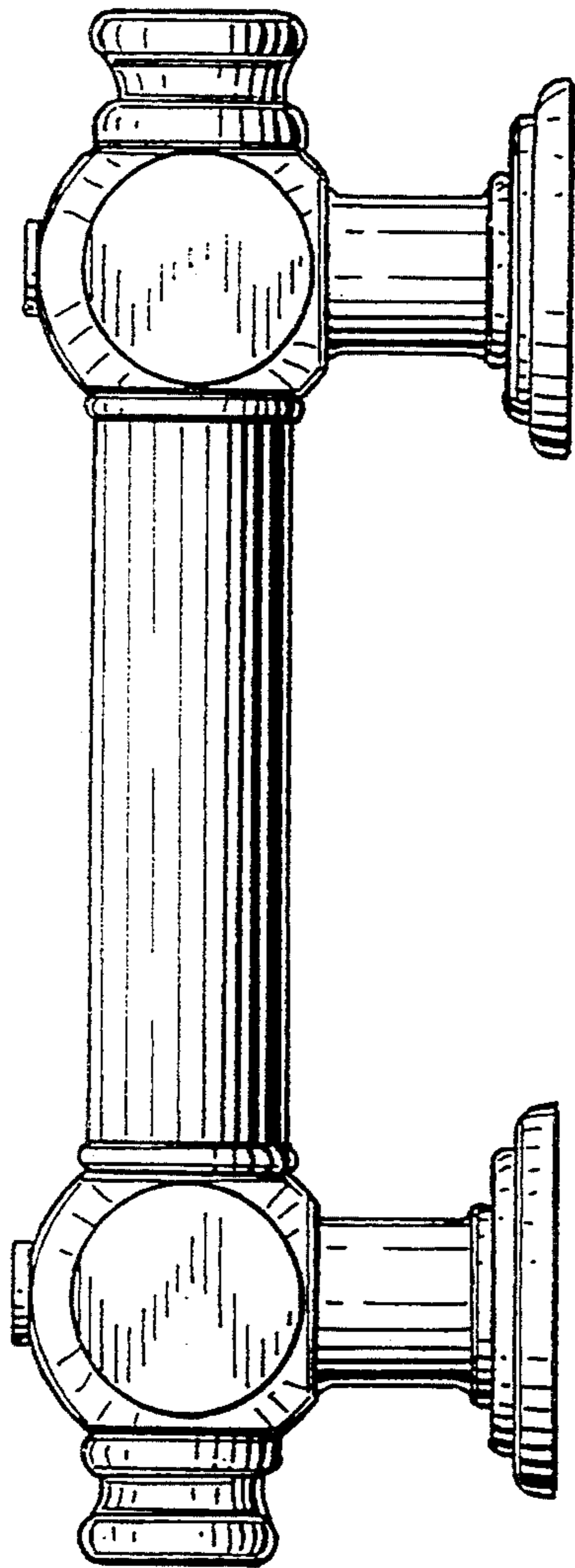

Fig. 8

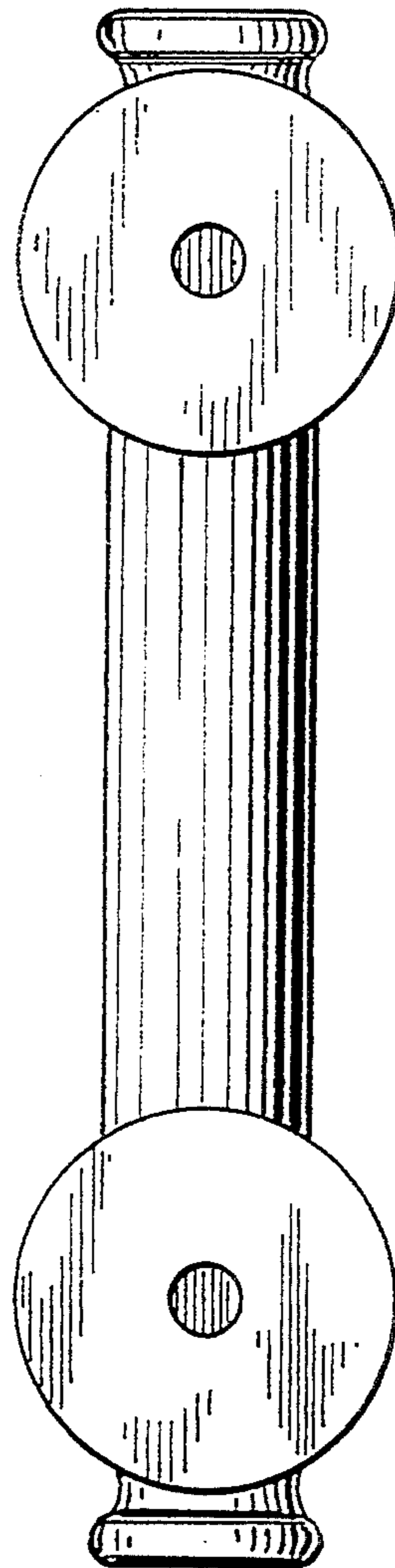

Fig. 9

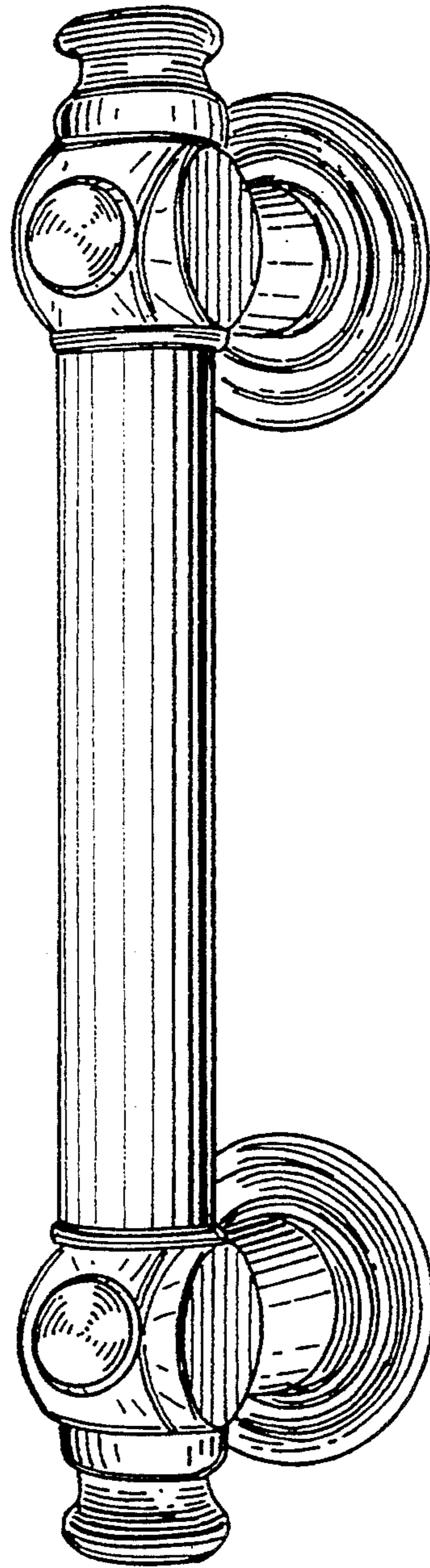

Fig. 10