



US00D361330S

United States Patent [19]

[11] Patent Number: **Des. 361,330**

Solomita et al.

[45] Date of Patent: **** Aug. 15, 1995**

[54] TELEPHONE

[75] Inventors: **Anthony Solomita, Norwalk; Barry M. Haber, Westport, both of Conn.; Robert Taylor, Clarksburg, N.J.**

[73] Assignee: **Conair Corporation, Stamford, Conn.**

[**] Term: **14 Years**

[21] Appl. No.: **18,648**

[22] Filed: **Feb. 14, 1994**

[52] U.S. Cl. **D14/149; D14/148**

[58] Field of Search **D14/137, 138, 140, 142, D14/147, 148, 149-151, 240, 248; 379/58-61, 419, 420, 428, 440, 433-436**

[56] **References Cited**

U.S. PATENT DOCUMENTS

D. 272,533	2/1984	Coons et al.	D14/138
D. 287,124	12/1986	Becker	D14/148
D. 287,362	12/1986	Rittenhouse et al.	D14/148
D. 299,026	12/1988	Iino	D14/148
D. 301,874	6/1989	Roegner	D14/148
D. 303,383	9/1989	Reichenstein	D14/149 X
D. 313,800	1/1991	Appleby	D14/151
D. 333,465	2/1993	Hayes et al.	D14/151 X

FOREIGN PATENT DOCUMENTS

1215958 12/1970 United Kingdom D14/ 151 X

Primary Examiner—Jeffrey Asch
Attorney, Agent, or Firm—Haynes N. Johnson

[57] **CLAIM**

The ornamental design for a telephone, as shown and described.

DESCRIPTION

FIG. 1 is a combined perspective view of the telephone receiver and of the base showing our new design; FIG. 2 is a perspective view of the telephone receiver at rest on the base; FIG. 3 is a bottom plan view of the receiver; FIG. 4 is a top plan view of the receiver; FIG. 5 is a front elevation of the receiver; FIG. 6 is a rear elevation of the receiver; FIG. 7 is a right side elevation of the receiver; FIG. 8 is a left side elevation of the receiver; FIG. 9 is a top plan view of the base; FIG. 10 is a bottom plan view of the base; FIG. 11 is a rear elevation of the base; FIG. 12 is a front elevation of the base; FIG. 13 is a left side elevation of the base; and, FIG. 14 is a right side elevation of the base. The receiver in FIGS. 3-8 and the base in FIGS. 9-14 are shown separately for convenience of illustration.

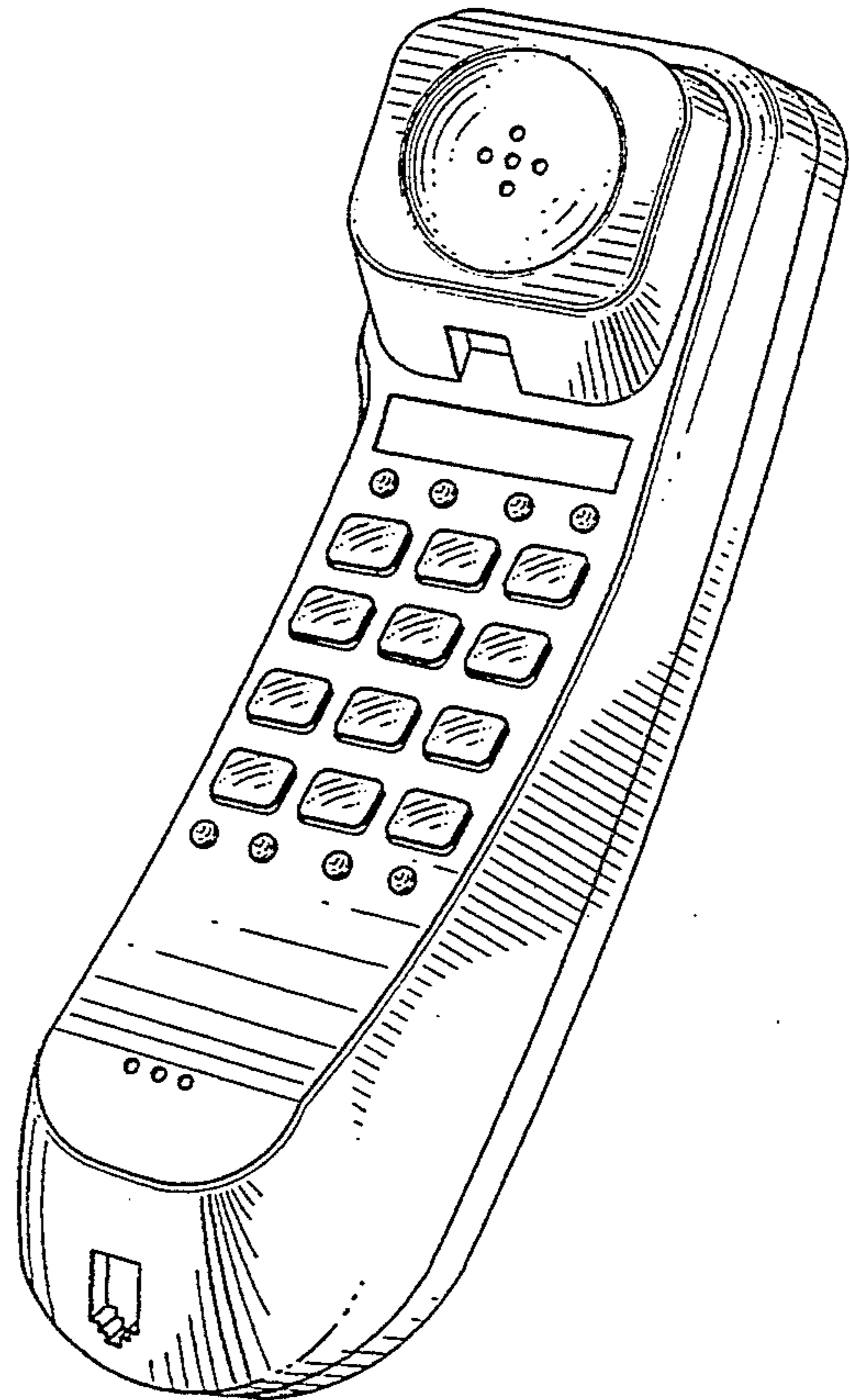
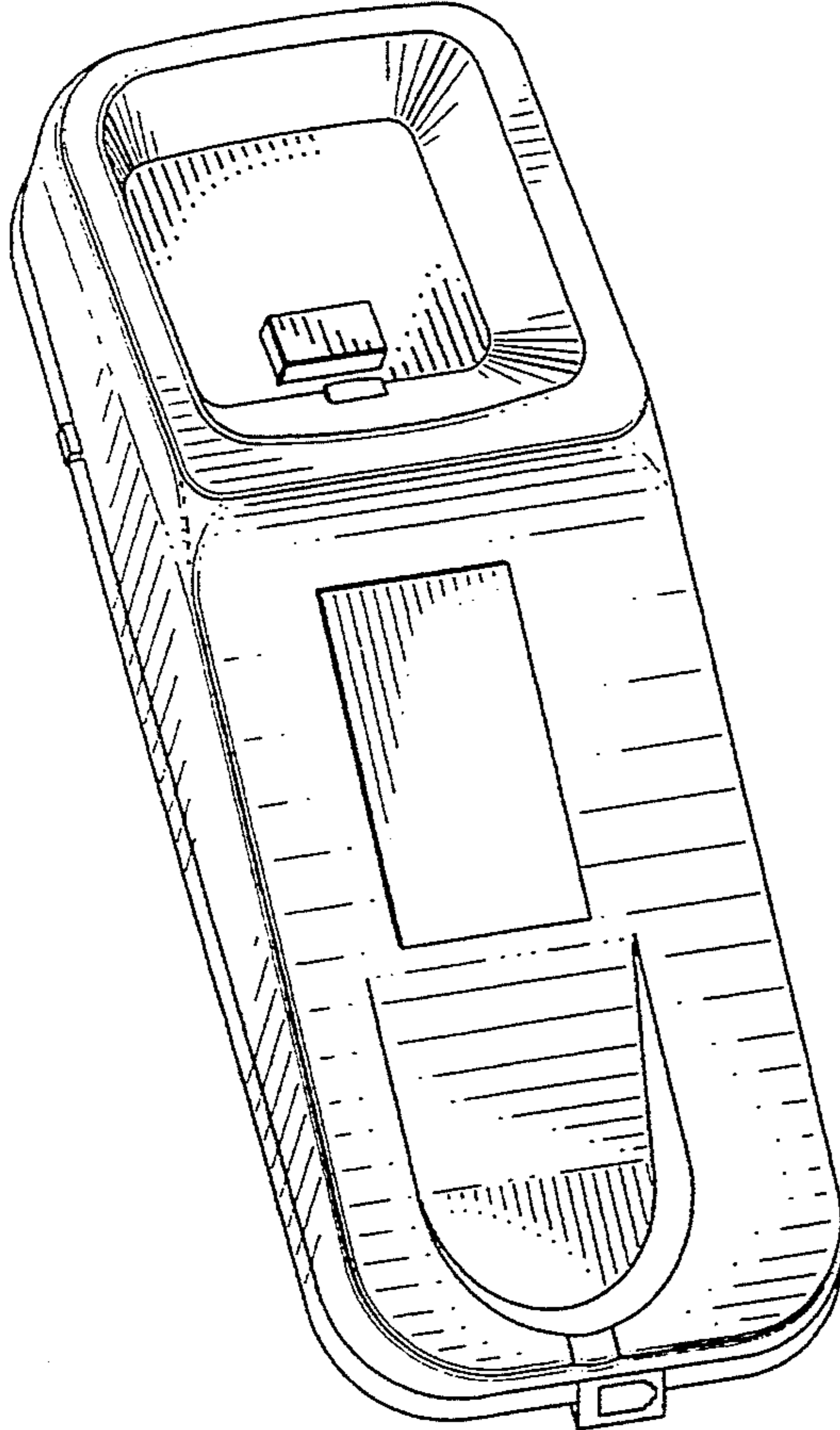

FIG. 1

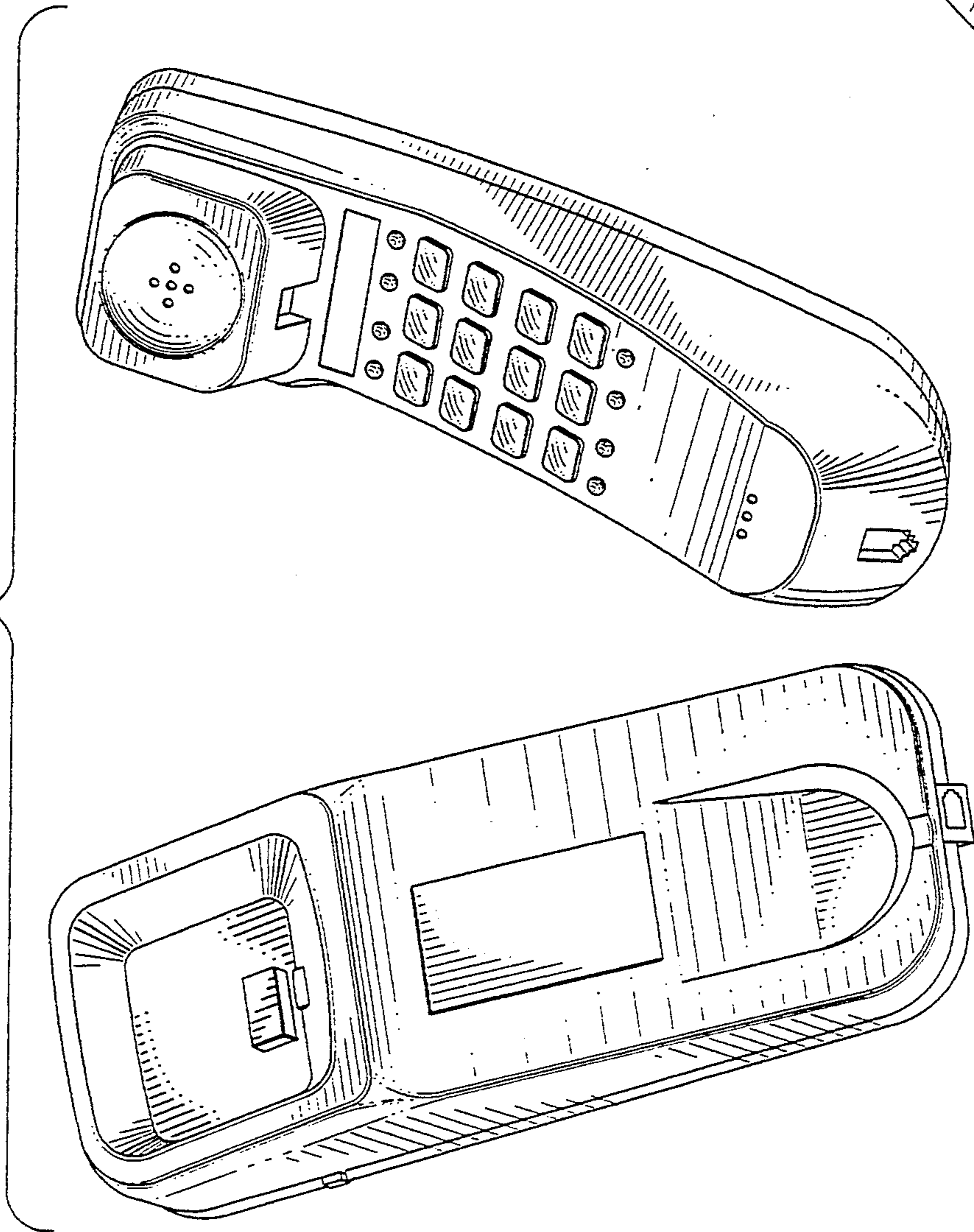
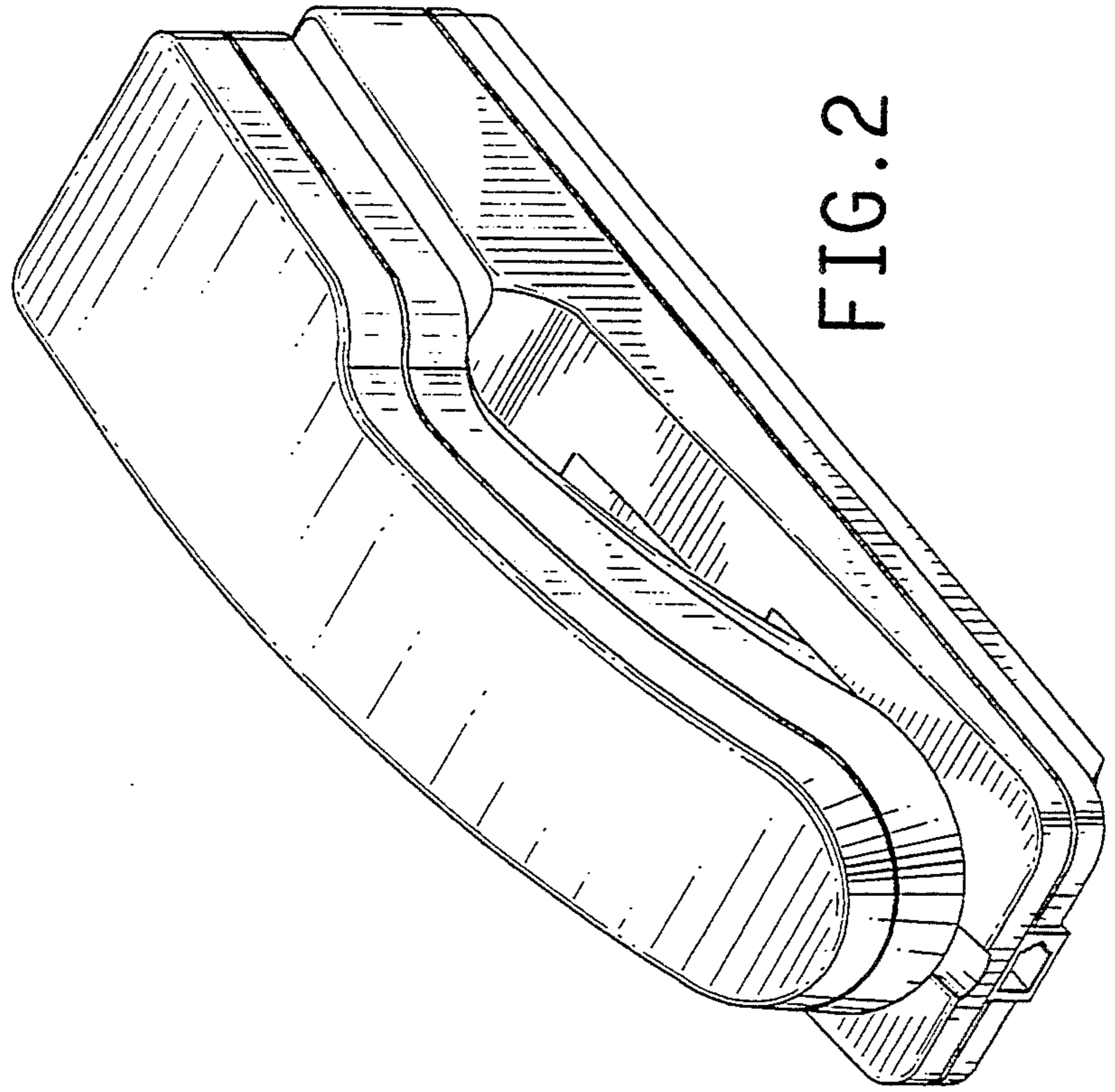

FIG. 2



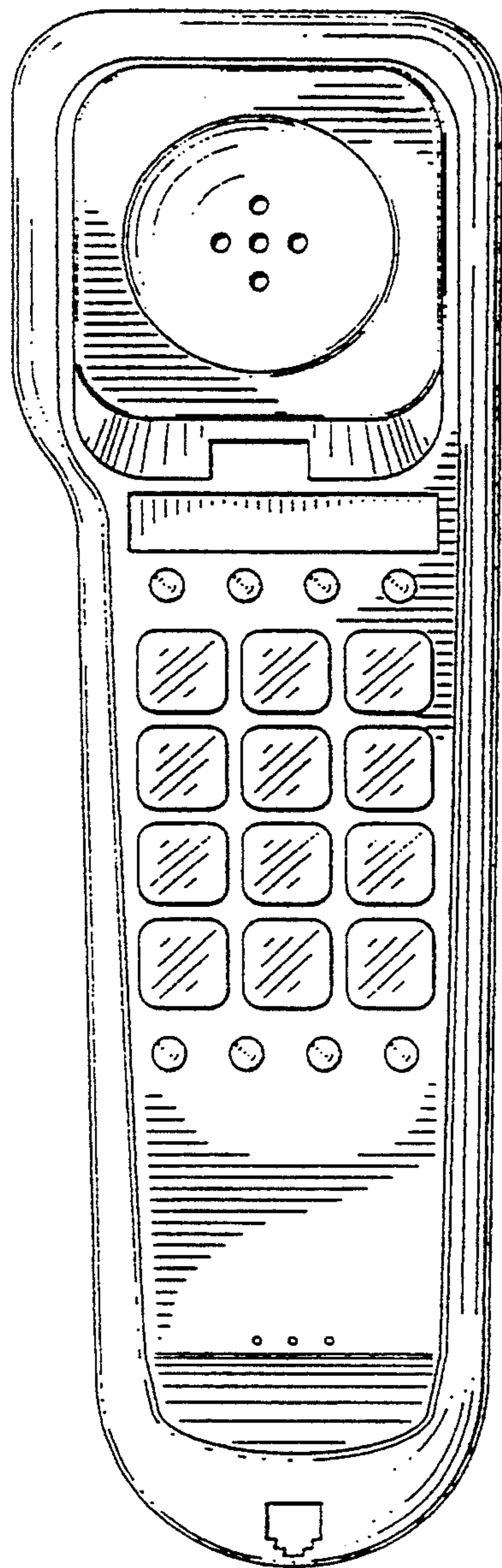

FIG. 3

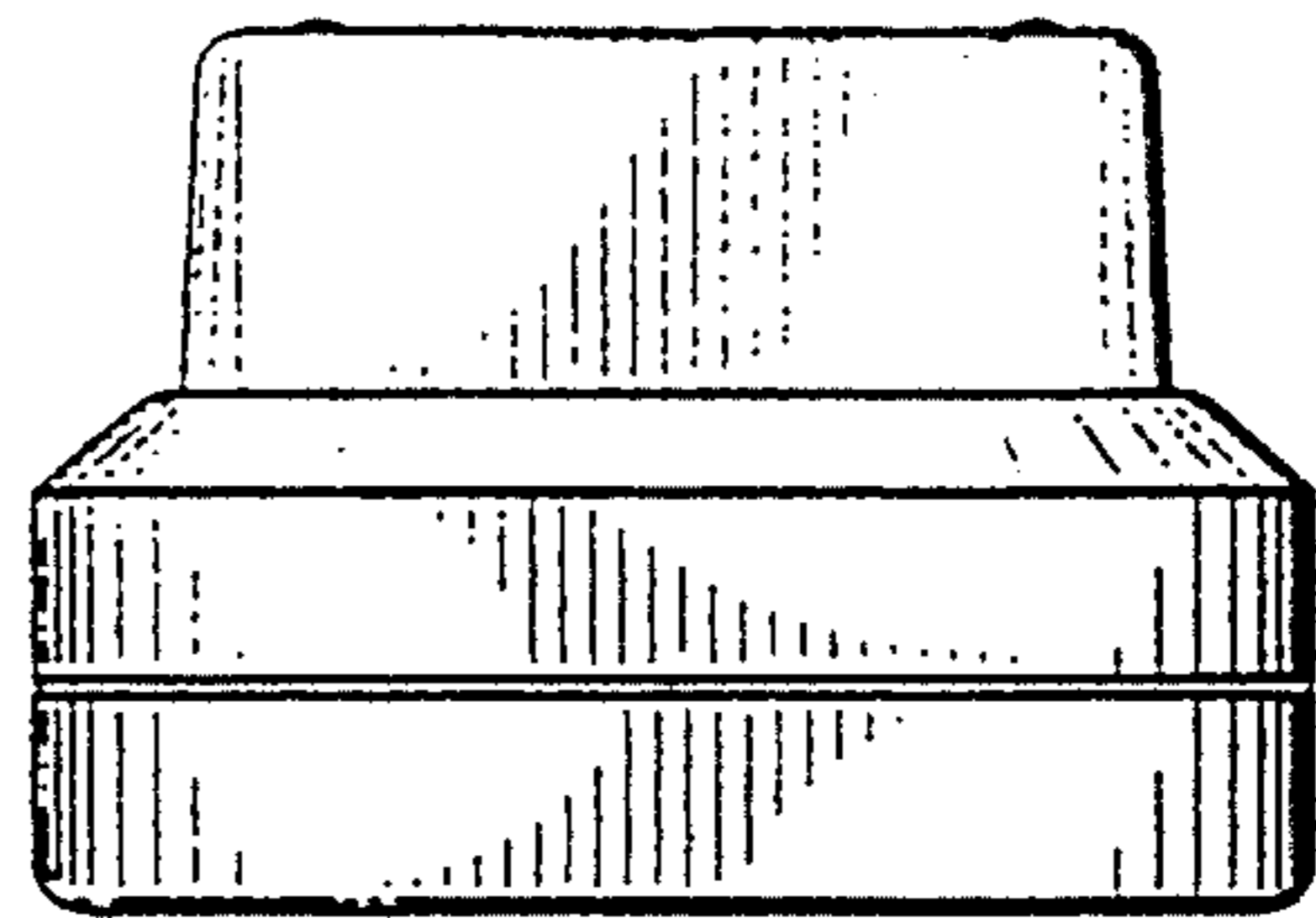

FIG. 5

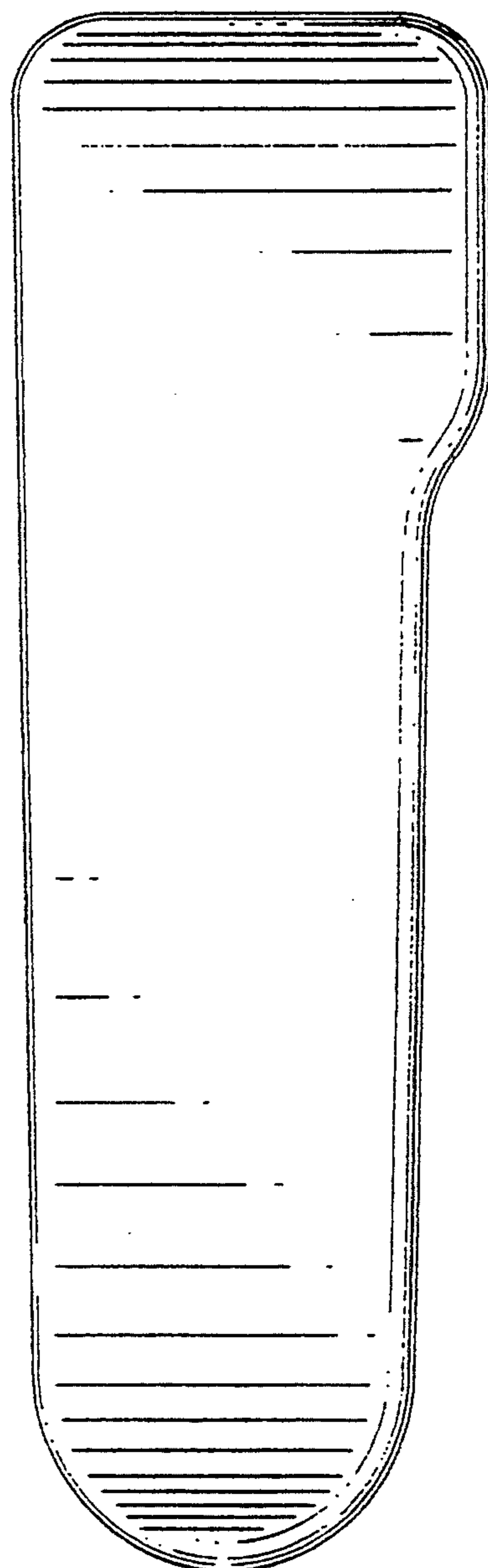

FIG. 4

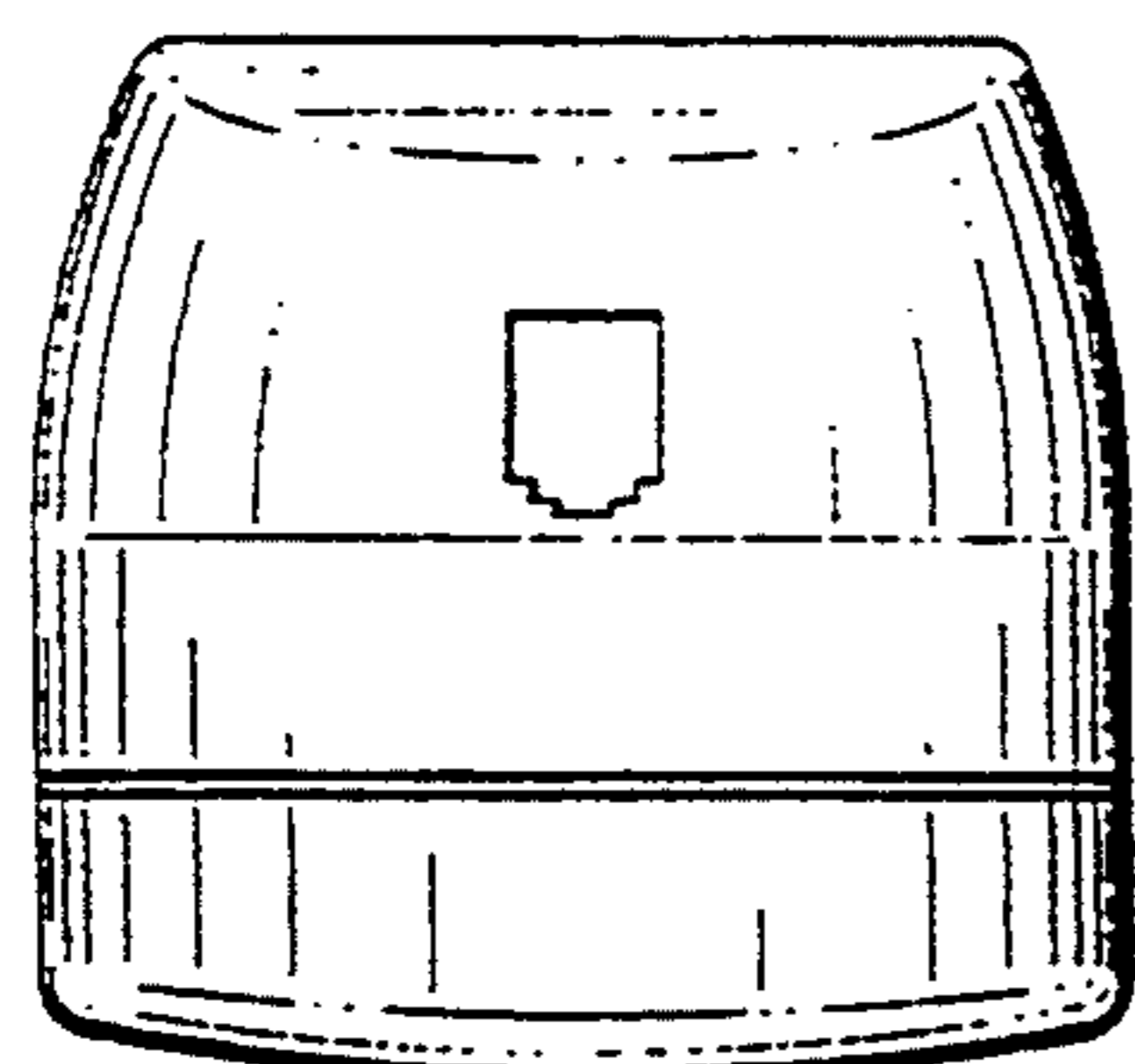

FIG. 6

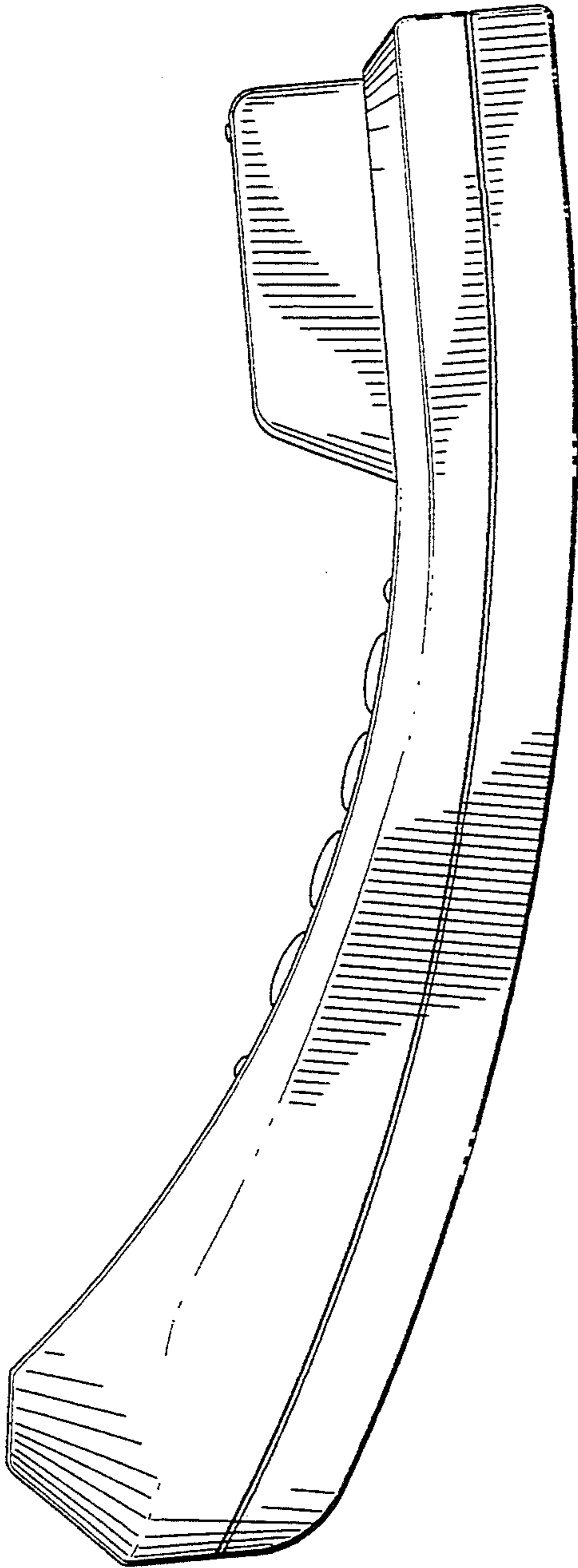

FIG. 7

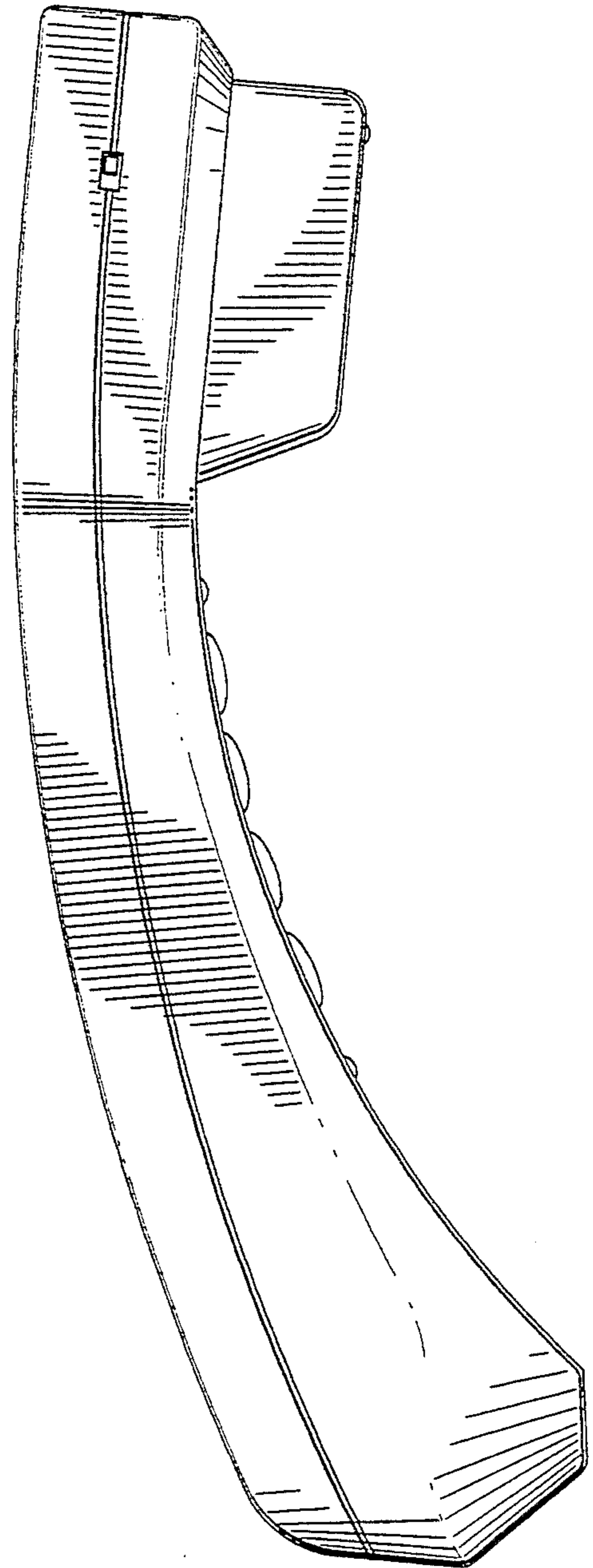

FIG. 8

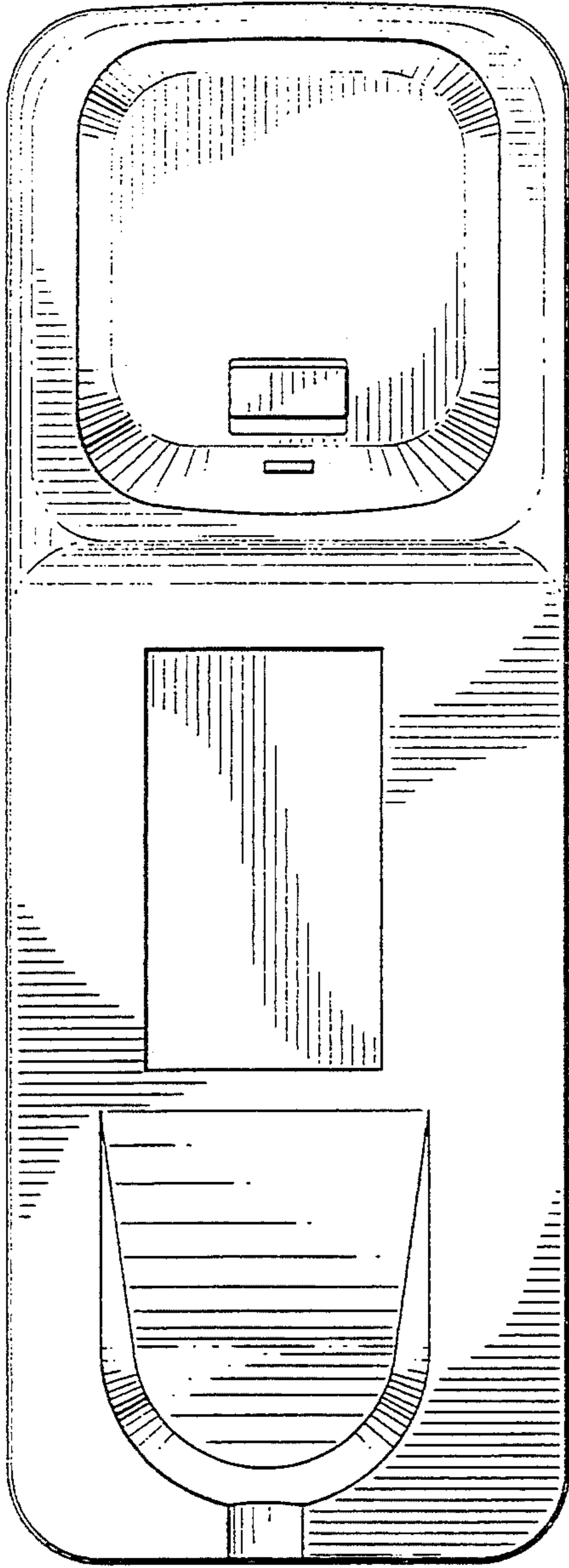

FIG. 9

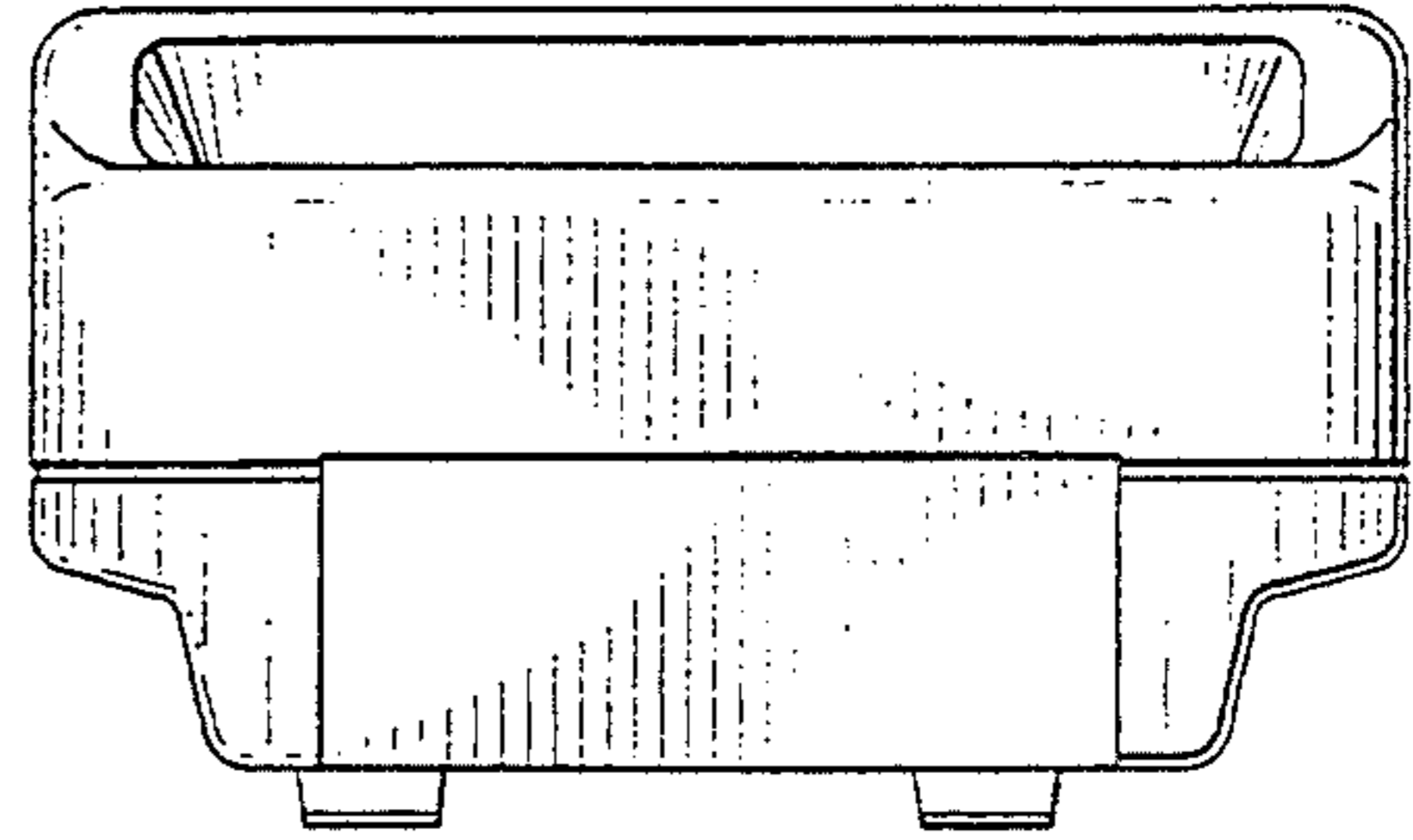

FIG. 11

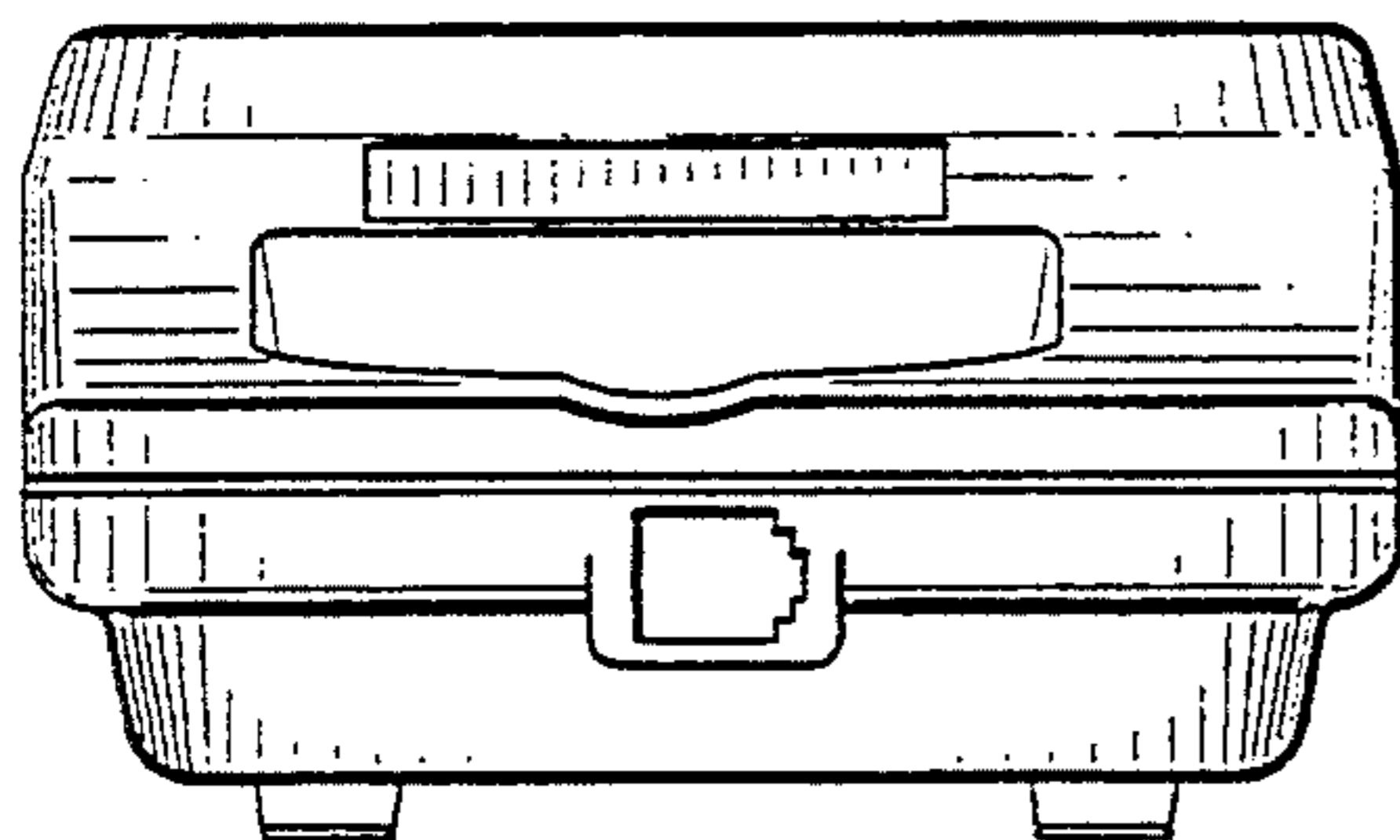

FIG. 12

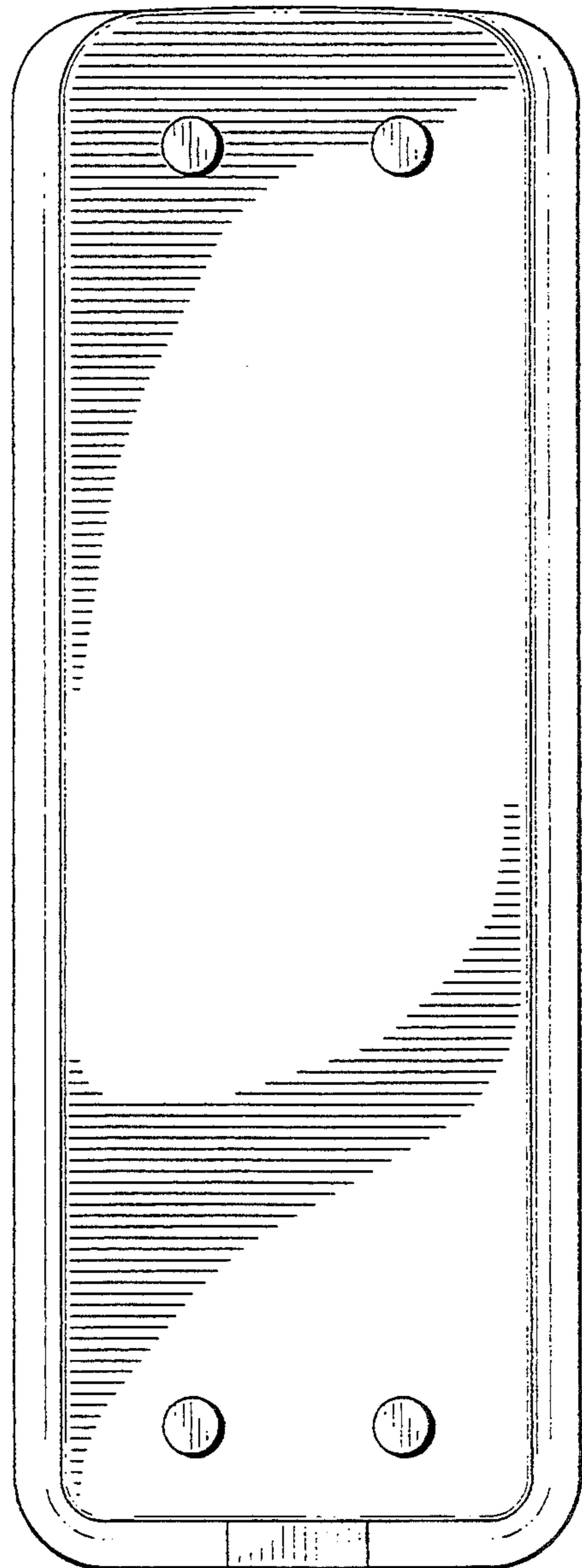

FIG. 10

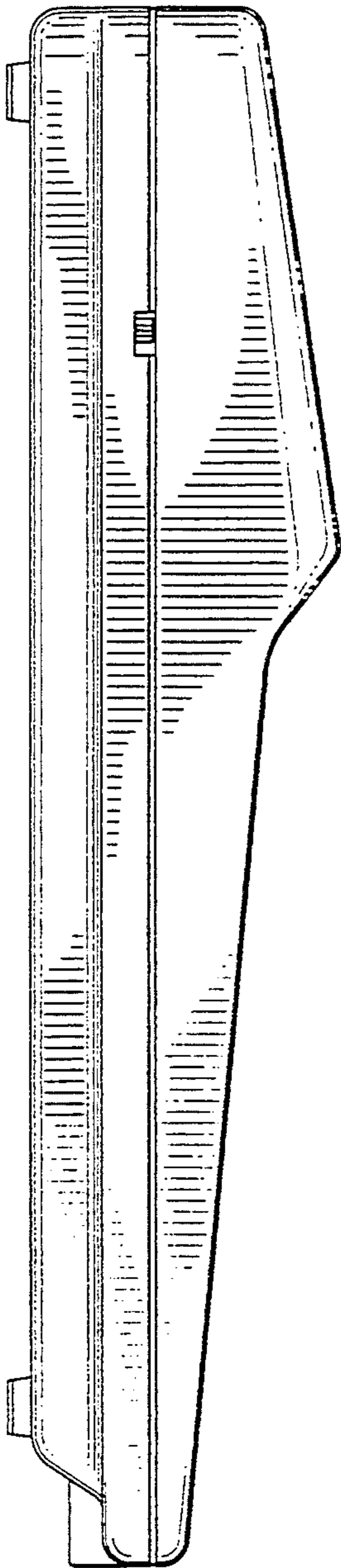

FIG. 13

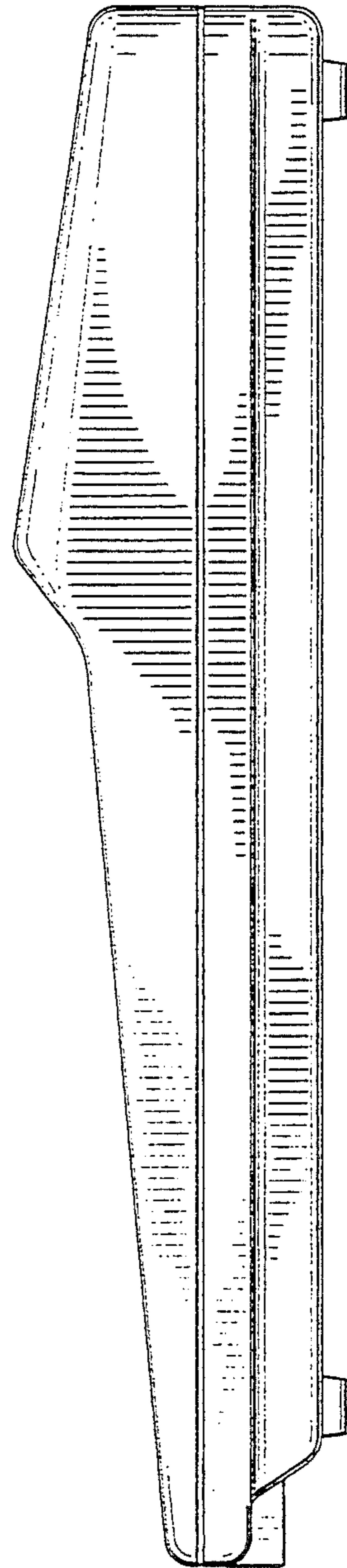

FIG. 14